



**HAL**  
open science

## RNF213-associated urticarial lesions with hypercytokinemia

Camille Louvrier, Fawaz Awad, Anne Cosnes, Elma El Khouri, Eman Assrawi, Aphrodite Daskalopoulou, Bruno Copin, H el ene Bocquet, Sandra Chantot Bastaraud, Angela Arenas Garcia, et al.

► **To cite this version:**

Camille Louvrier, Fawaz Awad, Anne Cosnes, Elma El Khouri, Eman Assrawi, et al.. RNF213-associated urticarial lesions with hypercytokinemia. *Journal of Allergy and Clinical Immunology*, 2022, Online ahead of print. 10.1016/j.jaci.2022.06.016 . inserm-03776857

**HAL Id: inserm-03776857**

**<https://inserm.hal.science/inserm-03776857>**

Submitted on 14 Sep 2022

**HAL** is a multi-disciplinary open access archive for the deposit and dissemination of scientific research documents, whether they are published or not. The documents may come from teaching and research institutions in France or abroad, or from public or private research centers.

L'archive ouverte pluridisciplinaire **HAL**, est destin ee au d ep ot et  a la diffusion de documents scientifiques de niveau recherche, publi es ou non,  emanant des  tablissements d'enseignement et de recherche fran ais ou  trangers, des laboratoires publics ou priv es.

1 ***RNF213*-associated urticarial lesions with hypercytokinemia**

2  
3 **Authors:** Camille Louvrier PharmD PhD<sup>1,2\*</sup>, Fawaz Awad MD PhD<sup>1‡\*</sup>, Anne Cosnes MD<sup>3\*</sup>,  
4 Elma El Khouri PhD<sup>1</sup>, Eman Assrawi MD PhD<sup>1</sup>, Aphrodite Daskalopoulou MSc<sup>1</sup>, Bruno  
5 Copin MSc<sup>1,2</sup>, H el ene Bocquet MD<sup>3</sup>, Sandra Chantot Bastaraud MD<sup>2</sup>, Angela Arenas Garcia  
6 MSc<sup>1</sup>, Florence Dastot Le Moal PhD<sup>2</sup>, Pierre De La Grange PhD<sup>4</sup>, Philippe Duquesnoy MSc<sup>1</sup>,  
7 Chiara I. Guerrera PhD<sup>5</sup>, William Piterboth BSc<sup>2</sup>, Nicolas Ortonne MD PhD<sup>6</sup>, Olivier  
8 Chosidow MD PhD<sup>3,7§</sup>, Sonia A. Karabina PhD<sup>1§</sup>, Serge Amselem MD PhD<sup>1,2\*\*</sup>, Irina  
9 Giurgea MD PhD<sup>1,2\*\*</sup>

10  
11 **AFFILIATIONS**

12 <sup>1</sup>Sorbonne Universit , Inserm, Childhood Genetic Disorders, H pital Armand-Trousseau,  
13 75012 Paris, France

14 <sup>2</sup>D partement de G n tique M dicale, Assistance Publique–H pitaux de Paris (APHP),  
15 H pital Armand-Trousseau, 75012 Paris, France

16 <sup>3</sup>Facult  de Sant  de Cr teil et Service de Dermatologie, APHP, H pital Henri-Mondor,  
17 Universit  Paris-Est, 94000 Cr teil, France

18 <sup>4</sup>GenoSplice, 75014 Paris, France

19 <sup>5</sup>Plateforme prot omique Necker, Universit  de Paris, Structure F d rative de Recherche  
20 Necker, Inserm US24/CNRS UMS3633, 75015 Paris, France

21 <sup>6</sup>D partement d’Anatomo-Pathologie, APHP, H pital Henri-Mondor, Cr teil 94000, France

22 <sup>7</sup>Research Group Dynamic, EA7380, Facult  de Sant  de Cr teil, Ecole Nationale V t rinaire  
23 d’Alfort, USC ANSES, Universit  Paris-Est Cr teil, 94000 Cr teil, France

24 <sup>‡</sup>Present address: Al-Quds University, Faculty of Medicine, Biochemistry and Molecular  
25 Biology Department; Abu Deis, Jerusalem, Palestine

26  
27 \*These authors contributed equally to this work.

28 <sup>§</sup>These authors contributed equally to this work.

29 \*\*These authors contributed equally as co-last authors.

30  
31 Correspondence to: Irina Giurgea and Serge Amselem, UMR\_S933 Inserm, Sorbonne  
32 Universit , H pital Armand Trousseau, 26, avenue du Dr. Arnold-Netter, 75012 Paris,  
33 France; Tel.: +33 1 44 73 52 39; Fax: +33 1 44 73 52 19; Email: [irina.giurgea@inserm.fr](mailto:irina.giurgea@inserm.fr);  
34 [serge.amselem@inserm.fr](mailto:serge.amselem@inserm.fr)

35

36 **FUNDING**

37 Institut National de la Santé et de la Recherche Médicale (INSERM) and Sorbonne University

38 Agence Nationale de la Recherche (ANR-17-CE17-0021-01)

39 H2020, European Union, Grant Agreement no. 779295 (SAK, SA)

40 INSERM “Poste d’accueil” program (00552404) (CL)

41 “Fondation pour la Recherche Médicale” (FDT20130928419) (FA)

42 French government grant (Ministère des Affaires Etrangères) (FA, EA)

43 Alquds University grant, Palestine (FA)

44 An-Najah University grant, Palestine (EA)

45

46

47 **ABSTRACT**

48

49 **Background.** Urticarial lesions are observed in both cutaneous and systemic disorders. Familial  
50 forms of urticarial syndromes are rare and can be encountered in systemic auto-inflammatory  
51 diseases.

52 **Objective.** We investigated a large family with dominantly inherited chronic urticarial lesions  
53 associated with hypercytokinemia.

54 **Methods.** We performed a genetic linkage analysis in 14 patients from a 5-generation family,  
55 as well as whole-exome sequencing, cytokine profiling and transcriptomic analyses on samples  
56 from two patients. The identified candidate protein was studied after *in vitro* expression of the  
57 corresponding normal and mutated recombinant proteins. An unsupervised proteomic approach  
58 was followed to unveil the associated protein network.

59 **Results.** The disease phenotype of the most affected family members is characterized by  
60 chronic urticarial flares associated with extremely high plasma levels of pro- (IL-1 $\beta$ , IL-6, TNF-  
61  $\alpha$ ) and anti-inflammatory (IL-10, IL1-RA) cytokines, with no secondary organ dysfunction, no  
62 susceptibility to infections, no fever and normal C-reactive protein levels. Monocyte  
63 transcriptomic analyses identified an immunotolerant profile in the most affected patient.  
64 Affected family members carried a loss-of-function mutation in *RNF213* that encodes mysterin,  
65 a protein of poorly known physiological role. We identified the deubiquitinase CYLD, a major  
66 regulator of inflammation, as an RNF213 partner and showed that CYLD expression is inhibited  
67 by wild-type but not mutant RNF213.

68 **Conclusion.** We identified a new entity characterized by chronic urticarial lesions associated  
69 with a clinically-blunted hypercytokinemia. This disease, due to a loss of function of RNF213,  
70 reveals mysterin's key role in the complex molecular network of innate immunity.

71

72 **KEY MESSAGES**

- 73
- 74 • We describe a new disease entity, characterized by urticarial lesions that segregate as a  
75 fully penetrant autosomal-dominant trait associated with a chronic and clinically  
76 blunted hypercytokinemia.
  - 77 • The obtained genetic and functional data reveal the critical role played by RNF213 in  
78 innate immunity.

78

79 **CAPSULE SUMMARY**

80 A germline mutation in *RNF213*, a new player in innate immunity encoding a protein called

81 mysterin, causes urticarial lesions associated with a clinically-blunted hypercytokinemia.

82

83 **KEY WORDS**

84 RNF213, hypercytokinemia, urticarial lesions, genetics

85

86 **ABBREVIATIONS**

87 CYLD: cylindromatosis

88 COVID-19: coronavirus-19 disease

89 CRP: C-reactive protein

90 DEG: differentially expressed genes

91 gnomAD: genome-aggregation database

92 HLA: human-leukocyte-antigen

93 IL: interleukin

94 IL-1RA: IL-1 receptor antagonist

95 IFN- $\gamma$ : interferon- $\gamma$

96 LOD: logarithm of the odds

97 LPS: lipopolysaccharide

98 MHC II: major histocompatibility complex class II

99 MMD: moyamoya disease

100 RING: really interesting new gene

101 RNF213: ring-finger protein-213

102 SAIDs: systemic autoinflammatory diseases

103 SAA: serum amyloid A

104 TNF- $\alpha$ : tumor necrosis factor- $\alpha$

105 WT: wild type

106 **MAIN TEXT**

107

108 **Introduction**

109

110 Urticaria is a common clinical condition characterized by the development of wheals and/or  
111 angioedema<sup>1, 2</sup>. Typical features of wheals include an itching sensation and a fleeting nature,  
112 the wheals lasting no more than 24 to 36 hours with no residual skin changes, whereas in its  
113 chronic form, the episodes last more than six weeks<sup>1</sup>. In addition, the patients with urticaria  
114 usually do not present with systemic symptoms.

115 In contrast to urticaria, the so-called “urticaria-like skin lesions” (or “urticarial skin  
116 lesions”) are typically non-pruritic. They have a long duration, wheals are fixed, lasting several  
117 days or weeks and their resolution frequently leaves marks such as hyperpigmentation. In  
118 addition, systemic symptoms can coexist thereby defining systemic urticarial syndromes as is  
119 the case with disorders like urticarial vasculitis or like systemic autoinflammatory disorders  
120 (SAIDs), a group of rare heterogeneous diseases partly explained by mutations in genes that  
121 regulate the innate immune response<sup>3</sup>. In SAIDs, the recurrent episodes of systemic  
122 inflammation are driven by an excessive production of pro-inflammatory cytokines.

123 Herein, we report a genetic disease characterized by that, from a nosographic point of view,  
124 does not fall into any of the above-mentioned groups of diseases. Chronic urticarial lesions  
125 evolving by flares are the only clinical symptoms that segregate as a fully penetrant autosomal-  
126 dominant trait within a large family in which several affected members present persistent and  
127 massive –but extremely well-tolerated–hypercytokinemia. Genetic linkage analysis combined  
128 with whole-exome sequencing identified a disease-causing germline mutation in ring-finger  
129 protein-213 (*RNF213*), which encodes a protein called mysterin whose biological properties are  
130 still largely unknown. Unsupervised transcriptomic and proteomic approaches enabled  
131 exploration of *RNF213*-dependent biological pathways implicated in this new entity.

132

133 **Methods**

134

135 ***Patients***

136 Clinical features were collected through a standardized form. The study conforms to the  
137 Helsinki declaration regarding ethical principles for medical research. Written informed  
138 consents were obtained from each patient or their parents.

139

140 ***Genetic studies***

141 Genomic DNA samples were obtained from 16 family members.

142 Whole-genome genotyping of 14 family members (affected and healthy) used the Infinium  
143 Human Linkage-12 Genotyping BeadChip (Illumina). The BeadChip includes 6090 common  
144 single-nucleotide polymorphism markers with an average spacing of 441 kb and 0.58  
145 centimorgan (cM) across the genome. Linkage analysis was performed with Merlin 1.1.2  
146 software, assuming autosomal-dominant inheritance, full penetrance, no consanguinity and a  
147 mutation-allele frequency < 0.001.

148 Genomic DNA samples prepared from peripheral blood leukocytes of patients 1 (P1) and  
149 2 (P2) were subjected to whole-exome sequencing, using the FlexiGene Kit (Qiagen). Exome-  
150 sequence libraries were prepared using a SeqCap EZ Human Exome Library Kit version 3.0  
151 (Roche NimbleGen) and sequenced using a Nextseq500 (Illumina). The identified sequence  
152 variation was validated by Sanger sequencing on an ABI 3130 XL automated capillary DNA  
153 sequencer (Applied Biosystems).

154

155 ***Histological analysis***

156 A skin punch biopsy was obtained from patient P1 under local anesthesia, then formalin-fixed  
157 and paraffin-embedded. Tissue sections (3- $\mu$ m thick) were stained with hematoxylin, eosin and  
158 saffron and, after antigen retrieval by heat in appropriate buffer, immunolabeled with anti-CD3  
159 (F.7.2.38 mouse monoclonal antibody, Dako), CD4 (4B12 monoclonal antibody, Leica), CD8  
160 (C8/144B mouse monoclonal antibody, Dako), perforin (5B10 mouse monoclonal antibody,  
161 BioSB, Diagnostics), granzyme B (11F1 mouse monoclonal antibody, Leica) and FOXP3  
162 (236A/E7 mouse monoclonal antibody, Abcam) antibodies, using the Bond III device (Leica  
163 Microsystems).

164

165 ***RNF213 plasmid constructs and transfection***

166 After reverse transcription, full-length *RNF213* cDNA underwent polymerase-chain reaction  
167 amplification (RT-PCR; Transcriptor High Fidelity cDNA Synthesis Kit, Roche) in two  
168 fragments of the *RNF213* transcripts. Each fragment was subcloned into pcDNA3.1/V5-His  
169 TOPO TA (Invitrogen). Each of the full-length *RNF213* cDNAs (WT and C41777R) was  
170 subsequently assembled into the pmaxGFP expression vector using the NEB builder Hifi DNA-  
171 Assembly Kit (New England BioLabs). Detailed method is provided in the **Supplemental data**  
172 **1 in the Online Repository.**

173 HEK293T cells were transfected with different amounts of *RNF213* plasmids using  
174 FUGENE HD (Promega).

175

### 176 *Cell-culture conditions*

177 Monocytes were isolated from peripheral blood (EDTA-containing tubes) of P1, P2 and healthy  
178 donors provided by the Etablissement Français du Sang. For cytokine measurements, adherent  
179 monocytes were treated for 24 hours with 100 ng/ml lipopolysaccharide (LPS) and cell-culture  
180 supernatants were used for ELISA.

181 Dermal fibroblasts were isolated from skin biopsies obtained from P1, P2 and two healthy  
182 donors after obtaining their informed consent according to the Declaration of Helsinki.

183 Immortalized B lymphocytes were generated from three healthy donors' peripheral blood,  
184 at the Centre de Ressources Biologiques of Cochin Hospital (APHP, Paris).

185 HEK293T cells were maintained in standard conditions.

186 Detailed methods are provided in the **Supplemental data 1 in the Online Repository.**

187

### 188 *Cytokine measurements*

189 Patients' – P1, P2, P3 and P4 – and controls' plasma samples were prepared and stored  
190 immediately at  $-80^{\circ}\text{C}$ , until analysis. Supernatants of adherent monocytes isolated from healthy  
191 controls' and patients' blood samples were centrifuged for 10 minutes at 250 *g* and stored at  
192  $-80^{\circ}\text{C}$ , until analysis. Cytokine concentrations were determined with ELISAs, according to the  
193 manufacturer's instructions (DuoSet ELISA kits, R&D, Biotechne).

194

### 195 *Cell-lysate preparations*

196 Cells (fibroblasts, immortalized B lymphocytes and HEK293T cells) were suspended in ice-  
197 cold lysis buffer (50 mM Tris, 100 mM NaCl, 5 mM EDTA, 1% Triton X-100, and phosphatase  
198 inhibitor (Roche Diagnostics) containing Complete Protease Inhibitor Cocktail (Roche  
199 Diagnostics). Lysates were incubated for 1 hour under agitation at  $4^{\circ}\text{C}$  and cleared by 10



200 minutes of centrifugation at 1000 g, 4°C.

201

### 202 ***Antibodies***

203 Rabbit anti-human RNF213 polyclonal antibody (HPA003347, Sigma) was used for  
204 immunoprecipitation and immunoblot assays. Mouse anti-human cylindromatosis (CYLD)  
205 monoclonal antibody (sc-74434, Santa Cruz Biotechnology) and rabbit anti-human CYLD  
206 (D1A10) polyclonal antibody (8462S, Cell Signaling) were used for immunoblotting.

207

### 208 ***Immunoblotting***

209 Cell lysates were loaded onto sodium dodecyl sulfate–polyacrylamide gel electrophoresis  
210 (SDS–PAGE) plates, transferred onto a PolyVinylidene Fluoride (PVDF) or nitrocellulose  
211 membranes, blocked for 1 hour in PBS–Tween 0.1% (PBS-T)–5% skim milk and analyzed by  
212 Western-blotting with different antibodies, incubated overnight at 4°C in PBS-T–5% milk. The  
213 secondary antibody (rabbit– or mouse–horseradish peroxidase) was incubated for 1 hour at  
214 room temperature in PBS-T–5% milk. Proteins were detected with Amersham ECL Select  
215 Western-Blotting Detection Reagent (GE healthcare), according to the manufacturer’s  
216 recommendations.

217

### 218 ***Cycloheximide (CHX) assay***

219 HEK293T cells were transfected with RNF213\_WT or RNF213\_C4177R and treated with  
220 CHX (100 µg/ml) at different times during the 24 hours posttransfection, then washed with PBS  
221 and stored at –20°C until analysis.

222

### 223 ***Immunoprecipitation***

224 Cell lysates (500 µl) of immortalized B cells and HEK293T cells were incubated overnight at  
225 4°C with 2 µg of the anti-human RNF213 antibody. Cell lysates/antibody mixtures were then  
226 incubated with Pierce<sup>TM</sup> Protein G Magnetic Beads (ThermoFisher) for 1 hour at 4°C and  
227 washed five times with 500 µl of ice-cold lysis buffer, before being eluted after a 15-minute  
228 incubation with 40 µl of Leamml buffer.

229

### 230 ***Nanoscale liquid chromatography coupled to tandem mass spectrometry (NanoLC MS/MS)*** 231 ***protein identification and quantification***

232 Immunoprecipitation (IP) eluates were subjected to S-Trap<sup>TM</sup> micro-spin column digestion.  
233 Samples were injected into a nanoRSLC-Q Exactive PLUS (RSLC Ultimate 3000) (Thermo

234 Scientific). Peptides were loaded onto a  $\mu$ -precursor column, and separated on a 50-cm reversed-phase  
235 liquid-chromatography column (Thermo Scientific). Peptides eluted from the column were  
236 analyzed by data-dependent MS/MS, using the top-10 acquisition method. Detailed method is  
237 provided in the **Supplemental data 1 in the Online Repository**.

238

#### 239 *NF- $\kappa$ B luciferase-reporter assay*

240 HEK293T cells were co-transfected in 12-well plates with the following plasmids: 100 ng of  
241 *Firefly* luciferase-expression plasmid driven by NF- $\kappa$ B-responsive elements (pGL4.32,  
242 Promega), and 50 and 200 ng of pmaxGFP-vector or pRNF213-expression plasmids. Cells were  
243 lysed 40 hours posttransfection and subjected to luciferase-reporter assays (Promega) using a  
244 TriStar LB 941 Multimode Microplate Reader (Berthold Technologies).

245

#### 246 *Quantitative RT-PCR*

247 Total RNA (1 $\mu$ g) from dermal fibroblasts was extracted using the RNeasy Mini Kit (Qiagen)  
248 and then subjected to reverse transcription with the Reverse Transcriptase Kit (Roche). The real-  
249 time PCR assays were performed in the Light Cycler LC480 (Roche). Detailed method is  
250 provided in the **Supplemental data 1 in the Online Repository**.

251

#### 252 *RNA-sequencing and transcriptomics analyses*

253 mRNA-sequencing libraries (mRNA isolated from the monocytes of P1 and P2 and two healthy  
254 controls) were prepared with TruSeq Stranded mRNA kit (Illumina), according to supplier's  
255 recommendations and sequenced on paired-end 75 bp of Illumina HiSeq4000. Detailed method  
256 is provided in the **Supplemental data 1 in the Online Repository**.

257 RNA-Seq data are deposited at the National Center for Biotechnology Information in the Gene  
258 Expression Omnibus database (<https://www.ncbi.nlm.nih.gov/geo/query/acc.cgi?acc=GSE168721>,  
259 token: upahmkssptmfhcb).

260

#### 261 *Analysis of proteomics data*

262 Results of RNF213 IP followed by nanoLC-MS/MS protein identification were analyzed with  
263 Perseus software. To avoid false-positive partners, only high-confidence interactions and  
264 specific interactions (interactors not detected with beads alone without IP) were retained.

265 Metascape (<http://metascape.org>)<sup>4</sup> was used on gene lists to analyze enrichment. That  
266 analysis included terms from Reactome Gene Sets, GO Biological Processes, and KEGG  
267 Pathways.

268

269 *Statistical analyses*

270 Differences were analyzed using unpaired Student *t*-tests and were plotted with Prism 9,

271 GraphPad software, (San Diego, CA). A *P* value  $\leq 0.05$  defined statistical significance.

272

273 **Results**

274

275 *Disease phenotype*

276 We studied a multiplex family with urticarial lesions segregating as an autosomal-dominant  
277 trait (**Figure 1A**). Affected family members had early-onset episodes (age 6 months to 25 years)  
278 of nonpruritic fixed urticarial lesions characterized by erythematous and edematous hives  
279 spontaneously resolving after several weeks into large violaceous macules that fade over time,  
280 but persist over months or years (**Figure 1B**). These cutaneous lesions displayed an episodic  
281 course and were triggered by seasonal temperature variations; the patients spontaneously  
282 reported an exacerbation of their cutaneous symptoms after a drop in ambient temperature.  
283 However, all the ice cube tests performed in one of the patients (Patient 1) remained negative.

284 **Patient 1** (P1), now a 55-year-old woman, first consulted in our dermatology department in  
285 1987, because of the occurrence since the age of 12 of erythematous, nonpruritic, urticarial  
286 lesions on her ankles. Over the years, as the flares became more frequent, cutaneous lesions  
287 extended over the trunk, arms, legs and face. During her 35-year follow-up, she never  
288 experienced any other symptoms: especially no fever, arthralgias or angioedema. Histological  
289 examination of P1's biopsied lesional skin revealed minor inflammatory infiltrates in the upper  
290 dermis, interspersed with uninvolved, normal epidermis. Infiltrates were comprised of small  
291 lymphocytes admixed with few neutrophils and scattered nuclear debris, without vasculitis  
292 (**Figure E1 in the Online Repository**). The investigations performed over the years  
293 documented chronic lymphopenia (0.4 to 0.6 G/l), with markedly low CD4<sup>+</sup> T cells (167  
294 cells/ $\mu$ l) and modestly low CD8<sup>+</sup> T cells (167 cells/ $\mu$ l) (see **Figure E2.A in the Online**  
295 **Repository**) and, sometimes, antinuclear antibody-positivity (titers range 80 to 1280, with no  
296 other autoantibodies). Conventional inflammatory parameters, e.g., Plasma C-reactive protein  
297 (CRP) and serum amyloid A (SAA) levels were within normal and in subnormal ranges,  
298 respectively. Complement system tests (total complement activity, C3 and C4) were also within  
299 normal ranges (see **Figure E2.A in the Online Repository**). Serum-protein electrophoresis  
300 showed mild polyclonal gammopathy with no monoclonal gammopathy. Although no definite  
301 diagnosis could be made, and because of the psycho-social burden experienced by P1, several  
302 treatment lines, e.g., antihistamines, hydroxychloroquine, methotrexate, thalidomide, dapsone  
303 or colchicine, were tried but had no efficacy. More targeted treatment such as anakinra or  
304 adalimumab were prescribed, each for 3 to 6 months with no regression of the cutaneous  
305 lesions. Prednisone 20 mg/day or topical clobetasol propionate 0.05% (20 g/day) provided  
306 partial lesion attenuation but was difficult to sustain over the long-term.

307 **Patient 2** (P2) is a 56-year-old woman who first consulted in our department in 1987 because  
308 of skin lesions, similar to those of her sister P1, and localized on arms and buttocks. The lesions  
309 appeared when she was 1-year old but did not extend over the years. During her 34-year follow-  
310 up, she did not complain of any other symptoms. Like her sister, no biological inflammation  
311 was observed (see **Figure E2.A in the Online Repository**). Topical clobetasol propionate  
312 0.05% (20 g/week) provided partial lesion attenuation.

313 **Other affected family members:** Nine other family members exhibiting the same cutaneous  
314 lesions were identified (**Figure 1C**). All of them had early-onset episodes (from the age of 6  
315 months to 25 years). The lesions were similar to those of P1 and P2. None of the patients  
316 reported other symptoms, fever, arthralgias or angioedema. Furthermore, they never had serious  
317 infections. Routine biological tests performed in 4 of these patients are provided in **Figure E2.A**  
318 **in the Online Repository**.

319 Notably, a large intrafamilial contamination with COVID-19 (confirmed by SARS-Cov-2 Real-  
320 time PCR test assay) occurred in 2020. None of the family members was vaccinated at that  
321 time. P1 had transitory anosmia, headaches and odynophagia, and her 87-year-old mother,  
322 transient fever and fatigue. The other affected family members were asymptomatic.

323

### 324 *Massive hypercytokinemia and monocyte immunosuppression*

325 P1's and P2's plasma inflammatory cytokine levels were determined at different times over  
326 3 years. Plasma levels of proinflammatory (e.g., interleukin (IL)-1 $\beta$ , IL-6, IL-1 $\alpha$ , IL-8 and  
327 tumor necrosis factor- $\alpha$  (TNF- $\alpha$ )) and anti-inflammatory mediators (like IL-1 receptor-  
328 antagonist (IL1-RA) and IL-10) were extremely elevated, P1 having higher plasma levels of all  
329 cytokines (**Figure 2A**). Moreover, P1 had high levels of the Th2-type cytokine IL-4, while P2's  
330 IL-4 was below the detection limit. Conversely, P1's and P2's Th1-type cytokines IL-12 and  
331 interferon- $\gamma$  (IFN- $\gamma$ ) were comparable to those of healthy controls (**Figure 2A**). Levels of all  
332 these cytokines remained constant over time, even when P1 received anti-TNF (adalimumab)  
333 or anti-IL1 (anakinra) agents. We also measured, in the same assay; the plasma cytokine levels  
334 (i.e., IL-1 $\beta$ , TNF- $\alpha$ , IL-6 and IL-10) of P1 and P2 together with two additional patients from  
335 this family (P3 and P4) (see **Figure E2.B in the Online Repository**). This analysis revealed  
336 that the hypercytokinemia of P1 and P4—the patients with the most severe skin lesions—was  
337 massive, whereas, P3, had cytokine levels within the normal range.

338 Furthermore, we studied cytokine secretion in the supernatants of monocytes isolated from  
339 P1, P2 and healthy donors, before and after lipopolysaccharide (LPS) stimulation. Notably,

340 after LPS stimulation, P1's and P2's IL-1 $\beta$  levels were significantly lower in their monocyte  
341 supernatants than in those of healthy controls, while the other cytokines tested (TNF- $\alpha$ , IL-6  
342 and IL-18) did not differ significantly (**Figure 2B**). Additionally, the amount of IL-6 in the  
343 supernatants of cultured skin fibroblasts isolated from P1 and P2 was similar to that of healthy  
344 donors (see **Figure E2.C in the Online Repository**).

345 In an attempt to identify a possible dysregulation of the gene networks associated with this  
346 massive hypercytokinemia, monocytes from P1, P2 and two healthy controls were subjected to  
347 transcriptomic analysis (RNA-Seq). Differentially expressed genes (DEGs) were analyzed  
348 between each patient and mean healthy control values (i.e., DEGs with  $P \leq 0.05$  and a |fold  
349 change|  $\geq 1.5$ ). That analysis showed that P1's gene-expression dysregulation was more  
350 pronounced than P2's (2,011 and 675 DEGs, respectively, see **Table E1.A and E1.B in the**  
351 **Online Repository**), in keeping with the severity of their disease phenotypes. The significantly  
352 upregulated gene set was enriched in several pathways, such as: "positive regulation of cell  
353 migration" (GO:0030335), "myeloid leukocyte activation" (GO:0002274) and "response to  
354 bacterium" (GO:0003617) (**Figure 2C**, see **Figure E3.A, Table E1.C and E1.D in the Online**  
355 **Repository**), and mainly concerned P1 who has a more severe disease. Notably, eight of P1's  
356 top-20 upregulated genes (*OLFM4*, *RETN*, *BPI*, *LCN2*, *LTF*, *CAMP*, *MMP8* and *ARG1*) are  
357 overexpressed during sepsis<sup>5-9</sup> (see **Figure E3.B in the Online Repository**), with *ARG1* being  
358 considered a potential mediator of sepsis-induced immunosuppression<sup>8</sup>.

359 To further investigate the relationships between P1's transcriptomic profile and that of  
360 patients with sepsis (i.e., patients with prominent hypercytokinemia), we took advantage of  
361 available transcriptomic datasets (GSE133822) from the monocytes of 33 patients with sepsis<sup>8</sup>.  
362 While relying on the list of P1's DEGs, we computed Pearson's correlation coefficients (using  
363 fold-change values) between P1, P2 or each of the 33 septic patients versus healthy samples  
364 from the same dataset, and between each of the 33 septic patients (**Figure 2D**). A strong  
365 correlation was found between P1's transcriptomic data and that of each septic patient, similar  
366 to what was found between each of the 33 septic patients (respective mean coefficient  
367 correlations of 0.36 and 0.42, see **Table E1.E in the Online Repository**). Among the set of  
368 downregulated genes (see **Figure E3.C, Table E1.F and E1.G in the Online Repository**), P1's  
369 human-leukocyte-antigen (HLA) transcripts encoding the cell-surface receptors of major  
370 histocompatibility complex class II (MHC II), including HLA-DR, were downregulated  
371 (**Figure 2E**); such HLA-DR downregulation is a known biomarker of monocyte  
372 immunosuppression<sup>10</sup>.

373

374 ***Identification of a pathogenic mutation in RNF213***

375 To determine the molecular basis of this condition that segregates as an autosomal-dominant  
376 trait (**Figure 1A**) with complete penetrance and variable expressivity, genetic linkage analysis  
377 was done on 14 family members. A significant logarithm of the odds (LOD) score was  
378 identified for a single 3.3-Mb region of chromosome 17 (chr17:76141133–79461642; hg19  
379 genome assembly) (see **Figure E4.A in the Online Repository**). Whole-exome sequencing of  
380 P1 and P2 identified a single variation absent from the genome-aggregation database  
381 (gnomAD): c.12529T>C p.(Cys4177Arg) in *RNF213*, a large gene that contains 68 exons (see  
382 **Figures E4.B to E4.D in the Online Repository** and **Figure 3A**). As expected from the genetic  
383 linkage data, this missense variation perfectly segregates with the phenotypic status of all 16  
384 family members tested (**Figure 1A**). The RNF213 protein (also known as mysterin) is a large,  
385 ubiquitously expressed 5207-amino-acid protein. It comprises an AAA core with ATPase  
386 activity and an E3 module harboring a RING (really interesting new gene)-finger domain with  
387 E3 ubiquitin-ligase activity<sup>11</sup>. The identified sequence variation leads to amino-acid substitution  
388 at codon 4177 involving a cysteine, invariant throughout evolution and located within the E3  
389 module (**Figure 3A**). Taken together, these data strongly suggest that the c.12529T>C  
390 p.(Cys4177Arg) missense variation identified in *RNF213* is causative in this family.

391 To further confirm this hypothesis, we first assessed the potential impact of the identified  
392 missense variation on RNF213 transcripts and proteins isolated from the patients' dermal  
393 fibroblasts (two independent skin biopsies (P1- and P2SB1, and P1- and P2SB2) for each  
394 patient). *RNF213*-mRNA expression did not differ between patients' fibroblasts and those of  
395 controls (see **Figure E5.A in the Online Repository**). However, RNF213-protein levels were  
396 significantly lower in both patients' fibroblasts, suggesting that the p.(Cys4177Arg) variation  
397 affected RNF213 half-life (**Figure 3B** and see **Figure E5.B in the Online Repository**).

398 After subcloning the full-length 15-kb *RNF213* cDNA in a eukaryotic expression vector,  
399 RNF213 stability was examined in HEK293T cells expressing recombinant forms of the protein  
400 carrying the p.(Cys4177Arg) variation or not (i.e., RNF213\_C4177R or wild-type  
401 RNF213\_WT, respectively). The experimental results revealed a shorter half-life  
402 RNF213\_C4177R as compared to its WT counterpart (4 vs. 6.5 hours,  $P = 0.0234$ ; **Figure 3C**,  
403 see **Figure E5.C in the Online Repository**), a result supporting that the p.(Cys4177Arg)  
404 variation is a loss-of-function mutation.

405 Taking advantage of the recent finding suggesting that RNF213 is a positive regulator of  
406 NF- $\kappa$ B signaling<sup>12, 13</sup>, we used an NF- $\kappa$ B-dependent luciferase-reporter assay to assess the  
407 impact of the identified mutation on that signaling activity (**Figure 3D**). As expected,

408 HEK293T cells transfected with the expression plasmid encoding RNF213\_WT displayed  
409 enhanced NF- $\kappa$ B activity, compared to mock-transfected cells; however, cells expressing  
410 RNF213\_C4177R had completely lost NF- $\kappa$ B activation.

411 Taken together, these observations demonstrate RNF213 involvement in the pathogenesis of  
412 family's disease phenotype.

413

#### 414 ***RNF213 role in inflammation***

415 To further investigate the molecular mechanism underlying this disease condition and gain  
416 additional insight into the RNF213-dependent biological pathways, we used an unsupervised  
417 proteomic approach to identify cell-protein partners interacting with RNF213. To do so, we  
418 immunoprecipitated RNF213 from two different cell types—immortalized B cells (from three  
419 healthy controls) and native HEK293T cells—followed by nanoLC-MS/MS protein  
420 identification and quantification. That analysis identified 104 RNF213 interactors, 64 in  
421 immortalized B cells and 60 in HEK293T cells, with 20 shared by B cells and HEK293T cells  
422 (see **Figure E6.A**, **Table E2.A** and **E2.B in the Online Repository**), thereby confirming the  
423 robustness of the approach used.

424 Protein-enrichment analysis revealed RNF213-associated biological pathways, several of  
425 which agree well with the patients' hypercytokinemia, i.e., "cytokine-mediated signaling  
426 pathways" (GO:0019221), and with innate immunity, i.e., "budding and maturation of HIV  
427 virions" (R-HSA-162588), and "positive regulation of viral release from host cells"  
428 (GO:1902188) (**Figure 4A**, and see **Table E2.C** and **E2.D in the Online Repository**). Notably,  
429 the proteins involved in the cytokine-mediated signaling pathway include well-known  
430 immunity regulators, such as CYLD, ISG15, OAS2 and ISG20. Among them, CYLD  
431 (cylindromatosis), detected in both cell types, is a deubiquitinase that negatively regulates the  
432 NF- $\kappa$ B pathway<sup>14</sup>. The RNF213–CYLD interaction was confirmed in HEK293T by co-  
433 immunoprecipitation followed by western-blot analysis (see **Figure E5.B in the Online**  
434 **Repository**).

435 We subsequently tested the impact of RNF213 on CYLD expression, to determine whether  
436 the latter could represent a functional link between RNF213 and the NF- $\kappa$ B pathway. To this  
437 end, HEK293T cells were transfected with the RNF213\_WT- or RNF213\_C4177R-encoding  
438 constructs (**Figure 4C**). RNF213\_WT-expressing cells expressed significantly less CYLD  
439 protein than mock-transfected cells, and that lower expression was partially lost when cells  
440 were transfected with mutated *RNF213* (**Figure 4C**). These CYLD-expression results are



441 consistent with the effects of RNF213\_WT and RNF213\_C4177R that we observed on NF- $\kappa$ B  
442 activation (**Figure 3D**).

443

## 444 **Discussion**

445

446 Herein, we describe a novel entity characterized by the association of urticarial lesions with  
447 chronic and massive—but well-tolerated—hypercytokinemia. We provide genetic and  
448 molecular evidence supporting that this disease, which is a genetic condition segregating as a  
449 fully penetrant trait with variable expressivity, is due to a germline mutation in *RNF213*.  
450 Additional functional studies based on unsupervised approaches identified the key role played  
451 by mysterin—the *RNF213*-encoded protein—in the complex network of proteins involved in  
452 innate immunity.

453 From a nosographic viewpoint, it is important to underline the fact that the skin lesions of  
454 this family, although resembling urticaria, differ from urticaria in that they are non-pruritic  
455 and fixed, spontaneously resolving in pigmented scars that fade over time. Moreover, unlike  
456 what is observed in SAIDs, the patients from this family have never reported any inflammatory  
457 systemic symptom (while P1 and P2 have been followed twice a year for more than 30 years).  
458 Furthermore, in spite of the absence of systemic symptoms, several patients have extremely  
459 high plasma cytokine levels.

460 The hypercytokinemia identified in P1 and P2 from this family is not an acute phenomenon  
461 but persists in a chronic state, as documented by the patients' long-term follow-up. In P1, the  
462 most severely affected, several proinflammatory cytokine levels (e.g., IL-1 $\beta$ , TNF- $\alpha$  or IL-6)  
463 were much higher than those found in patients with an acute cytokine storm requiring intensive  
464 care, as seen in patients with severe sepsis<sup>15</sup> or COVID-19<sup>16, 17</sup>. Paradoxically, in our patients,  
465 the disease is extremely well-tolerated, without any organ dysfunction or general symptoms.  
466 The patients remained afebrile and plasma levels of common biological markers of systemic  
467 inflammation (e.g., CRP) were within normal ranges.

468 In an attempt to at least partly explain this clinical–biological dissociation, additional  
469 biological assays were undertaken. Indeed, the proinflammatory phenotype was associated with  
470 high plasma levels of IL-1–receptor antagonist and IL-10, two markers of an anti-inflammatory  
471 response. Transcriptomic analyses revealed an immunosuppressive phenotype of P1's  
472 monocytes, including less expression of MHC class II transcripts, thereby mimicking sepsis-  
473 induced immunosuppression. Pertinently, severe COVID-19 patients also exhibit these  
474 features<sup>14, 15</sup>.

475 P1's chronic lymphopenia is another element shared with septic patients in whom  
476 lymphopenia is a well-known phenomenon attributed to apoptosis<sup>18</sup>. In this context, it is worth  
477 noting that apoptosis contributes to sepsis-induced immunosuppression<sup>10</sup> through the immune  
478 tolerance induced by IL-10 secretion<sup>6</sup> and the shift of the Th1/Th2 balance towards Th2 cells<sup>19</sup>.  
479 P1's cytokine profile clearly favors this Th2 profile, with high plasma IL-4 and IL-10  
480 concentrations associated with IFN- $\gamma$  and IL-12 levels below the limit of detection. In contrast  
481 to patients with sepsis-induced cytokine storms, our patients had no heightened susceptibility  
482 to infections known to occur in acquired immunosuppression. As just recently noted, the  
483 putative impact of inborn errors in *RNF213* on adaptative immune responses is so far  
484 unknown<sup>20</sup>. The fact that our patients have no heightened susceptibility to infections provides  
485 a first answer to that question.

486 This disease, which is caused by a germline pathogenic *RNF213* mutation, is so far revealed  
487 by the study of a single family. Identification of additional families with inborn errors of  
488 *RNF213* associated with immune dysregulation would be of great help to better characterize  
489 this new disease entity. It should, however, be noted that the current data rely on the study of a  
490 five-generation family with more than 10 affected patients, the in-depth phenotyping of two of  
491 these patients through ~35 years of longitudinal follow-up, and a genetic strategy based on two  
492 unsupervised approaches (i.e., whole-genome linkage analysis with a LOD score >3 and whole  
493 exome sequencing). In addition, the results of different functional tests (i.e., CHX and NF- $\kappa$ B  
494 luciferase-reporter assays) confirmed that the sequence variation identified in *RNF213* is  
495 disease-causing. Notably, other *RNF213* sequence variations have been associated with  
496 moyamoya disease (MMD), a rare cerebral angiopathy characterized by progressive stenosis of  
497 the intracranial and internal carotid arteries, engendering ischemic and hemorrhagic stroke<sup>21, 22</sup>.  
498 In MMD, some *RNF213* variants, which are low-penetrant variants, are commonly considered  
499 genetic-susceptibility factors, suggesting that additional factors are required to develop the  
500 disease. In this setting, the identification of over 100 new RNF213-protein partners is valuable  
501 information that could contribute greatly to further deciphering MMD pathophysiology.  
502 Recently, two patients with a severe syndromic form of moyamoya disease (MMD) including  
503 skin involvement and *de novo* RNF213 missense variations have been reported in a clinical  
504 report<sup>23</sup>. Notably, for one of the two patients, the description of the skin lesions recalls the  
505 urticarial lesions observed in our family. Although no studies were performed to assess the  
506 functional consequences of the identified *RNF213* missense variations, the possibility that the  
507 disease of our family and of these two sporadic cases belong to the same nosological entity  
508 remains open.

509 In our study, RNF213 emerges as a new innate-immunity actor playing a key role in  
510 inflammation. That finding agrees with very recent results emphasizing RNF213's role during  
511 bacterial and viral infection<sup>20, 24, 25</sup>. Our analyses identified CYLD, an RNF213 cell-protein  
512 partner, as a potential missing link accounting for the ability of RNF213 to activate the NF-κB  
513 pathway. As demonstrated herein, RNF213 inhibited CYLD expression and, accordingly, the  
514 mutated RNF213 carrying the p.(Cys4177Arg) loss-of-function mutation failed to inhibit  
515 CYLD expression. Most importantly, CYLD deubiquitinase, which is known to inhibit the NF-  
516 κB pathway, activates cell death<sup>14</sup>. And as shown in the mouse, such cell death, in turn, drives  
517 severe skin inflammation<sup>26</sup>. It is therefore tempting to speculate that the impaired CYLD  
518 suppression observed in the context of RNF213\_C4177R is at least in part responsible for our  
519 patients' skin condition. Notably, a similar NF-κB blockade has already been described in  
520 genetic diseases with skin inflammation such as those due to loss-of-function mutations in  
521 *IKBKG* (the gene encoding NEMO, a substrate of CYLD)<sup>27</sup>, in *RELA* (the gene encoding p65,  
522 a NF-κB subunit)<sup>28</sup> or in *CARD14*<sup>29</sup>.

523 In summary, we describe a disease entity, characterized by urticarial lesions that segregate  
524 as a fully penetrant autosomal-dominant trait associated with a chronic, massive and clinically  
525 blunted hypercytokinemia. The genetic and functional data obtained during the course of this  
526 study, which reveal the critical role RNF213 played in innate immunity, should open new  
527 avenues for identifying novel insights in the regulation of the immune system. Identification of  
528 additional families with inborn errors of *RNF213* associated with immune dysregulation should  
529 help to better characterize this new disease entity and, therefore, identify an effective therapy.

530

531 **ACKNOWLEDGMENTS**

532 We are grateful to the patients and their family, whose cooperation made this study possible  
533 and Prof. Laurence Fardet for her contribution to clinical data acquisition. We also would like  
534 to thank Janet Jacobson for editing the manuscript.

535

536 **REFERENCES**

537

- 538 1. Zuberbier T, Aberer W, Asero R, Abdul Latiff AH, Baker D, Ballmer-Weber B, et al.  
539 The EAACI/GA(2)LEN/EDF/WAO guideline for the definition, classification,  
540 diagnosis and management of urticaria. *Allergy* 2018; 73:1393-414.
- 541 2. Peroni A, Colato C, Schena D, Girolomoni G. Urticarial lesions: if not urticaria, what  
542 else? The differential diagnosis of urticaria: part I. *Cutaneous diseases J Am Acad*  
543 *Dermatol* 2010; 62:541-55.
- 544 3. Manthiram K, Zhou Q, Aksentijevich I, Kastner DL. The monogenic autoinflammatory  
545 diseases define new pathways in human innate immunity and inflammation. *Nat*  
546 *Immunol* 2017; 18:832-42.
- 547 4. Zhou Y, Zhou B, Pache L, Chang M, Khodabakhshi AH, Tanaseichuk O, et al.  
548 Metascape provides a biologist-oriented resource for the analysis of systems-level  
549 datasets. *Nat Commun* 2019; 10:1523.
- 550 5. Almansa R, Ortega A, Avila-Alonso A, Heredia-Rodriguez M, Martin S, Benavides D,  
551 et al. Quantification of Immune Dysregulation by Next-generation Polymerase Chain  
552 Reaction to Improve Sepsis Diagnosis in Surgical Patients. *Ann Surg* 2019; 269:545-  
553 53.
- 554 6. Cohen G, Ilic D, Raupachova J, Horl WH. Resistin inhibits essential functions of  
555 polymorphonuclear leukocytes. *J Immunol* 2008; 181:3761-8.
- 556 7. Martin L, van Meegern A, Doemming S, Schuerholz T. Antimicrobial Peptides in  
557 Human Sepsis. *Front Immunol* 2015; 6:404.
- 558 8. Washburn ML, Wang Z, Walton AH, Goedegebuure SP, Figueroa DJ, Van Horn S, et  
559 al. T Cell- and Monocyte-Specific RNA-Sequencing Analysis in Septic and Nonseptic  
560 Critically Ill Patients and in Patients with Cancer. *J Immunol* 2019; 203:1897-908.
- 561 9. Hu Z, Murakami T, Suzuki K, Tamura H, Reich J, Kuwahara-Arai K, et al.  
562 Antimicrobial cathelicidin peptide LL-37 inhibits the pyroptosis of macrophages and  
563 improves the survival of polybacterial septic mice. *Int Immunol* 2016; 28:245-53.
- 564 10. Venet F, Demaret J, Gossez M, Monneret G. Myeloid cells in sepsis-acquired  
565 immunodeficiency. *Ann N Y Acad Sci* 2020.
- 566 11. Ahel J, Lehner A, Vogel A, Schleiffer A, Meinhart A, Haselbach D, et al. Moyamoya  
567 disease factor RNF213 is a giant E3 ligase with a dynein-like core and a distinct  
568 ubiquitin-transfer mechanism. *Elife* 2020; 9.
- 569 12. Piccolis M, Bond LM, Kampmann M, Pulimeno P, Chitraju C, Jayson CBK, et al.  
570 Probing the Global Cellular Responses to Lipotoxicity Caused by Saturated Fatty Acids.  
571 *Mol Cell* 2019; 74:32-44 e8.

- 572 13. Takeda M, Tezuka T, Kim M, Choi J, Oichi Y, Kobayashi H, et al. Moyamoya disease  
573 patient mutations in the RING domain of RNF213 reduce its ubiquitin ligase activity  
574 and enhance NFkappaB activation and apoptosis in an AAA+ domain-dependent  
575 manner. *Biochem Biophys Res Commun* 2020; 525:668-74.
- 576 14. Lork M, Verhelst K, Beyaert R. CYLD, A20 and OTULIN deubiquitinases in NF-  
577 kappaB signaling and cell death: so similar, yet so different. *Cell Death Differ* 2017;  
578 24:1172-83.
- 579 15. Gogos CA, Drosou E, Bassaris HP, Skoutelis A. Pro- versus anti-inflammatory cytokine  
580 profile in patients with severe sepsis: a marker for prognosis and future therapeutic  
581 options. *J Infect Dis* 2000; 181:176-80.
- 582 16. Wang SY, Takahashi T, Pine AB, Damsky WE, Simonov M, Zhang Y, et al. Challenges  
583 in interpreting cytokine data in COVID-19 affect patient care and management. *PLoS*  
584 *Biol* 2021; 19:e3001373.
- 585 17. Giamarellos-Bourboulis EJ, Netea MG, Rovina N, Akinosoglou K, Antoniadou A,  
586 Antonakos N, et al. Complex Immune Dysregulation in COVID-19 Patients with Severe  
587 Respiratory Failure. *Cell Host Microbe* 2020; 27:992-1000 e3.
- 588 18. Hotchkiss RS, Monneret G, Payen D. Sepsis-induced immunosuppression: from cellular  
589 dysfunctions to immunotherapy. *Nat Rev Immunol* 2013; 13:862-74.
- 590 19. Girkontaite I, Urbonaviciute V, Maseda D, Neubert K, Herrmann M, Voll RE.  
591 Apoptotic cells selectively suppress the Th1 cytokine interferon gamma in stimulated  
592 human peripheral blood mononuclear cells and shift the Th1/Th2 balance towards Th2.  
593 *Autoimmunity* 2007; 40:327-30.
- 594 20. They F, Martina L, Asselman C, Zhang Y, Vessely M, Repo H, et al. Ring finger  
595 protein 213 assembles into a sensor for ISGylated proteins with antimicrobial activity.  
596 *Nat Commun* 2021; 12:5772.
- 597 21. Kamada F, Aoki Y, Narisawa A, Abe Y, Komatsuzaki S, Kikuchi A, et al. A genome-  
598 wide association study identifies RNF213 as the first Moyamoya disease gene. *J Hum*  
599 *Genet* 2011; 56:34-40.
- 600 22. Liu W, Morito D, Takashima S, Mineharu Y, Kobayashi H, Hitomi T, et al.  
601 Identification of RNF213 as a susceptibility gene for moyamoya disease and its possible  
602 role in vascular development. *PLoS One* 2011; 6:e22542.
- 603 23. Strong A, O'Grady G, Shih E, Bishop JR, Loomes K, Diamond T, et al. A new syndrome  
604 of moyamoya disease, kidney dysplasia, aminotransferase elevation, and skin disease  
605 associated with de novo variants in RNF213. *American Journal of Medical Genetics*  
606 *Part A* 2021; 185:2168-74.
- 607 24. Otten EG, Werner E, Crespillo-Casado A, Boyle KB, Dharamdasani V, Pathe C, et al.  
608 Ubiquitylation of lipopolysaccharide by RNF213 during bacterial infection. *Nature*  
609 2021.
- 610 25. Houzelstein D, Simon-Chazottes D, Batista L, Tokuda S, Langa Vives F, Flamand M,  
611 et al. The ring finger protein 213 gene (Rnf213) contributes to Rift Valley fever  
612 resistance in mice. *Mamm Genome* 2021; 32:30-7.
- 613 26. Kumari S, Van TM, Preukschat D, Schuenke H, Basic M, Bleich A, et al. NF-kappa B  
614 inhibition in keratinocytes causes RIPK1-mediated necroptosis and skin inflammation.  
615 *Life Science Alliance* 2021; 4.

616 27. Smahi A, Courtois G, Vabres P, Yamaoka S, Heuertz S, Munnich A, et al. Genomic  
617 rearrangement in NEMO impairs NF-kappaB activation and is a cause of incontinentia  
618 pigmenti. The International Incontinentia Pigmenti (IP) Consortium. Nature 2000;  
619 405:466-72.

620 28. Badran YR, Dedeoglu F, Castillo JML, Bainter W, Ohsumi TK, Bousvaros A, et al.  
621 Human RELA haploinsufficiency results in autosomal-dominant chronic  
622 mucocutaneous ulceration. Journal of Experimental Medicine 2017; 214:1937-47.

623 29. Peled A, Sarig O, Sun GP, Samuelov L, Ma CA, Zhang Y, et al. Loss-of-function  
624 mutations in caspase recruitment domain-containing protein 14 (CARD14) are  
625 associated with a severe variant of atopic dermatitis. Journal of Allergy and Clinical  
626 Immunology 2019; 143:173-+.

627  
628  
629

630 **CONFLICT OF INTEREST**

631

632 The authors have no conflict of interest to declare.

633

634

635 **FIGURE LEGENDS**

636

637 **Figure 1. Genealogical tree of the studied family and clinical manifestations in affected**  
638 **members.** (A) Genealogical family tree showing co-segregation of chronic urticarial lesions  
639 (filled symbols) with the identified *RNF213* pathogenic variation. †, died (B) Patient 1's (P1)  
640 and 2's (P2) urticarial lesions. N: normal allele, M: mutated allele. (C) Clinical characteristics  
641 of affected family members.

642

643 **Figure 2. Hypercytokinemia and monocyte immunosuppression.** (A) ELISA-assessed  
644 plasma-cytokine levels of patients P1 and P2 (over 3 years) and 9–10 healthy donors (Ctr).  
645 (B) Cytokines (ELISA) in the supernatants of P1's ( $n = 4$ ) and P2's ( $n = 4$ ) and 5–6 healthy  
646 controls' untreated or lipopolysaccharide (LPS)-stimulated monocytes. A & B: means  $\pm$   
647 standard deviation. (C–E) RNA-Seq analyses of patients' monocytes expressed as fold  
648 changes (FC) compared to the mean Ctr value. (C) Heatmap of enriched terms across the list  
649 of patients' up-regulated genes, colored by  $P$ -values. (D) Heatmap of Pearson's correlation  
650 coefficients using patients' RNA-Seq data and 33 septic patients' monocyte transcriptomic  
651 datasets (GSE133822)<sup>5</sup>. Based on P1's list differently expressed genes (DEGs,  $|FC| > 1.5$ ,  $P <$   
652  $0.05$ ), Pearson's correlation coefficients (FC values) were calculated between P1 or P2 and  
653 each of the 33 septic patients and between each of the 33 septic patients (mean correlation  
654 coefficients = 0.36, 0.05 and 0.42, respectively). (E)  $|FCs|$  of P1's and P2's HLA mRNAs  
655 encoding major histocompatibility complex class II (MHCII). Underlined DEG values are  
656 significant ( $> 1.5$ ,  $P < 0.05$ ). Two-tailed  $P$  values were determined with unpaired  $t$ -tests. ns:  
657 not significant; \* $P \leq 0.05$ ; \*\* $P \leq 0.01$ ; \*\*\* $P \leq 0.001$ .

658

659 **Figure 3. *RNF213* p.(Cys4177Arg) mutation: identification and functional assessment.**  
660 (A) Top left: *RNF213*-gene schematic representation (exons (black), mutation-containing  
661 exon-47 (red)) and domain-organization model of the corresponding protein, showing the  
662 identified mutation. CTD, C-terminal domain. Top right: Sanger electrophoregram showing  
663 the heterozygous *RNF213* mutation c.12529T>C, p.(Cys4177Arg) (arrow). Bottom left:  
664 Evolutionary conservation of *RNF213*-protein amino-acid Cys4177 in different species.  
665 Bottom right: 3D structure of mouse *rnf213* (6TAX in the Protein Data Bank) Cys4171  
666 corresponding to human-*RNF213* Cys4177 in red. The E3 module includes: back (orange),  
667 RING (green), shell (yellow) and core (light yellow) subdomains. (B) *RNF213*-protein  
668 quantification in patient 1's (P1) and 2's (P2) dermal fibroblasts (independent skin biopsies



669 (SB1) and (SB2)) and two healthy controls. (C) Cycloheximide-assay assessment of *RNF213*  
670 p.(Cys4177Arg)-mutation impact on protein stability after transient mutated-protein  
671 expression in HEK293T cells ( $P = 0.023$ ). (D) *RNF213*-mutation impact on NF- $\kappa$ B activity.  
672 HEK293T cells were transfected with 50 or 200 ng of the WT or C4177R-mutant RNF213  
673 constructs or the pmaxGFP construct (mock) as control, and an NF- $\kappa$ B reporter construct (100  
674 ng). (B, C, D) Two-tailed  $P$  values were determined in unpaired  $t$ -tests of means  $\pm$  SD. ns: not  
675 significant;  $*P \leq 0.05$ ;  $***P \leq 0.001$ .

676

677 **Figure 4. Signaling pathways inferred from networks of proteins interacting with**  
678 **RNF213.** (A) Immunoprecipitation-assay identification of RNF213 partners in immortalized  
679 B cells and native HEK293T cells followed by NanoLC MS/MS. Proteins are grouped into  
680 clusters based on their similarities (networks of enriched terms are represented as pie charts,  
681 with pies color-coded based on cell type (red: HEK293T cells, blue: immortalized B cells);  
682 pie size is proportional to the total number of hits that fall into that specific term). Edge  
683 thickness between nodes represents the number of RNF213-interacting proteins shared by  
684 both pathways. Colored halos, which regroup closely related pathways, include the “cytokine-  
685 mediated signaling pathway” highlighted in bold. (B) List of protein partners of RNF213  
686 identified under the enriched term “Cytokine-mediated signaling pathway”. Red: HEK293T  
687 cells; blue: immortalized B cells. C. CYLD-protein quantification in HEK293T transfected  
688 with WT or C4177R-mutant pRNF213 constructs or the pmaxGFP construct (mock control).  
689 NT: not transfected. Two-tailed  $P$  values were determined with unpaired  $t$ -tests of means  $\pm$   
690 SD of five independent experiments.  $**P \leq 0.01$ ;  $***P \leq 0.001$ .

691

692 **Figure E1. Skin biopsy.** (A) Skin biopsy of urticarial lesions from patient (P) 1's back  
693 showing a minor infiltrate of small lymphocytes with rare neutrophils (arrowheads)  
694 surrounding small capillaries in the upper dermis and scattered nuclear debris interspersed  
695 with normal epidermis. (B) The infiltrate was predominantly comprised of CD3+ T cells,  
696 mixed with CD4+ helper and CD8+ cytotoxic T cells, with scattered FOXP3+ regulatory T  
697 cells and cytotoxic effectors (GrzB: Granzyme B, arrowheads). Scale bar: 100  $\mu$ m.  
698

699 **Figure E2. Laboratory parameters and plasma cytokine measurements.** (A) P1's and  
700 P2's laboratory findings. Abs: antibodies; NA: not available. (B) ELISA-assessed plasma-  
701 cytokine levels of patients P1 (red circle), P2 (red up-pointing triangle), P3 (red down-  
702 pointing triangle) and P4 (red square) and 10 healthy donors (HD) in scatter dot plots with  
703 median. (C) IL-6 (ELISA) in the supernatants of P1's ( $n = 2$ ) and P2's ( $n = 2$ ) and 2 healthy  
704 controls' untreated fibroblasts. A & B: means  $\pm$  standard deviation.  
705

706 **Figure E3. Enrichment analyses of differentially expressed genes (DEGs) expressed in**  
707 **patient (P) 1's and 2's monocytes.** (A) Top 10 enriched terms listed for up-regulated genes.  
708 (B) Fold change (FC) of the top 20 up-regulated genes expressed in P1 and P2. Up-regulated  
709 genes associated with sepsis are in red. (C) Top: Top 10 enriched terms listed for down-  
710 regulated genes. Bottom: Heatmap of enriched terms across the list of P1's and P2's down-  
711 regulated genes, colored by  $P$ -values.  
712

713 **Figure E4. Linkage analysis and whole-exome sequencing of patients (P) identifying the**  
714 ***RNF213* c.12529T>C, p.(Cys4177Arg) mutation.** (A) Linkage-analysis results of 14 family  
715 members (8 affected and 6 unaffected) expressed in centimorgans (cM). A genome-wide  
716 significant logarithm of the odds (LOD) score was obtained for a single 3.3-Mb region located  
717 on chromosome 17 (chr17: 76141133–79461642; hg19 genome assembly). (B) P1's and P2's  
718 sequence variations identified by whole-exome sequencing and stepwise-elimination process  
719 to identify the pathogenic sequence variation. (C) The 8 rare P1- and P2-shared variations  
720 located in the significant LOD-score chromosome region. (D) P1's and P2's exome-  
721 sequencing data. Visualization using Integrative Genomics Viewer (IGV) of the *RNF213*  
722 c.12529T>C, p.(Cys4177Arg) mutation.  
723

724 **Figure E5. In vitro study of RNF213 transcripts and protein.** (A) RNF213-mRNA relative  
725 expressions in dermal fibroblasts from patient (P) 1's and 2's skin biopsies (SB1 and SB2)  
726 and two healthy controls (Ctr). (B) Immunoblot analysis of RNF213 and  $\alpha$ -tubulin (as loading  
727 control) in P1's and P2's SB1 and SB2 dermal fibroblasts and a Ctr. (C) Immunoblot analysis  
728 of the stability of wild-type (WT) and mutated (C4177R) RNF213 proteins expressed in  
729 HEK293T cells and evaluated in the cycloheximide (CHX) assay (100  $\mu$ g/ml).

730

731 **Figure E6. RNF213–cell-protein interactions identified by immunoprecipitation (IP)**  
732 **followed by NanoLC MS/MS.** (A) Venn diagram of proteins interacting with RNF213 in  
733 immortalized B cells and in HEK293T cells. (B) Immunoblot analysis of RNF213 and CYLD  
734 after RNF213 immunoprecipitation (IP) of HEK293T cells transiently expressing the wild-  
735 type (WT) or mutated (C4177R) RNF213 protein.

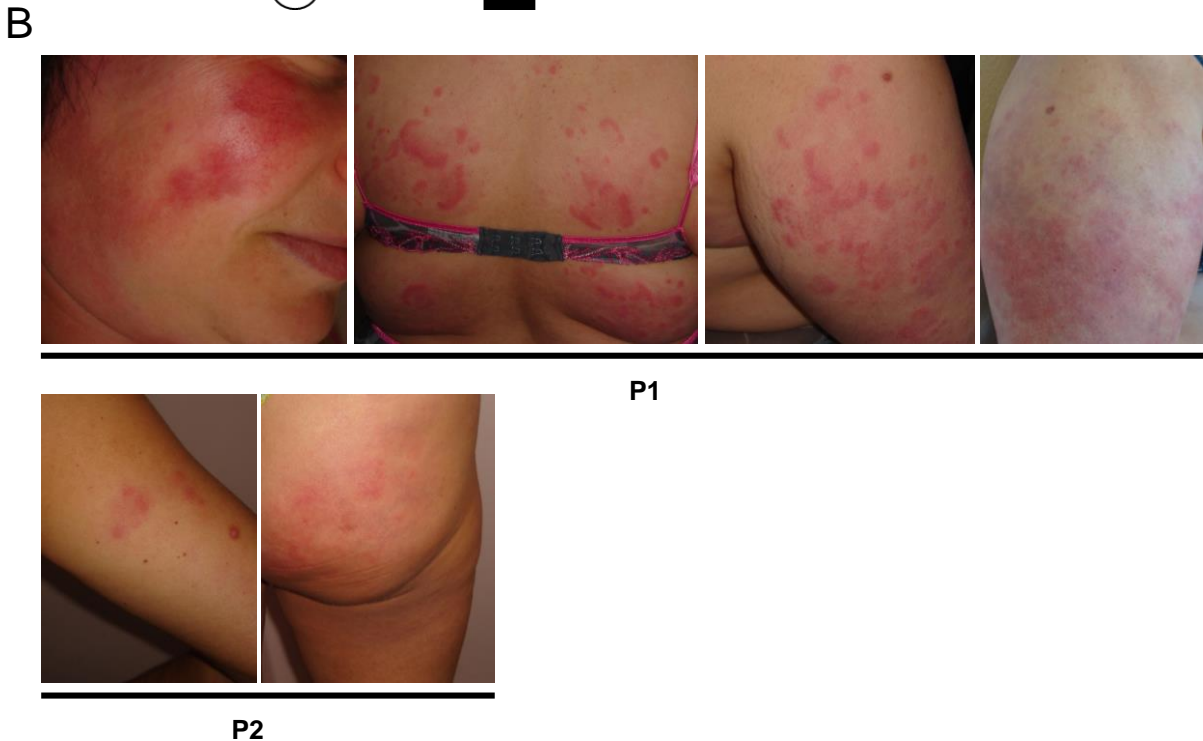
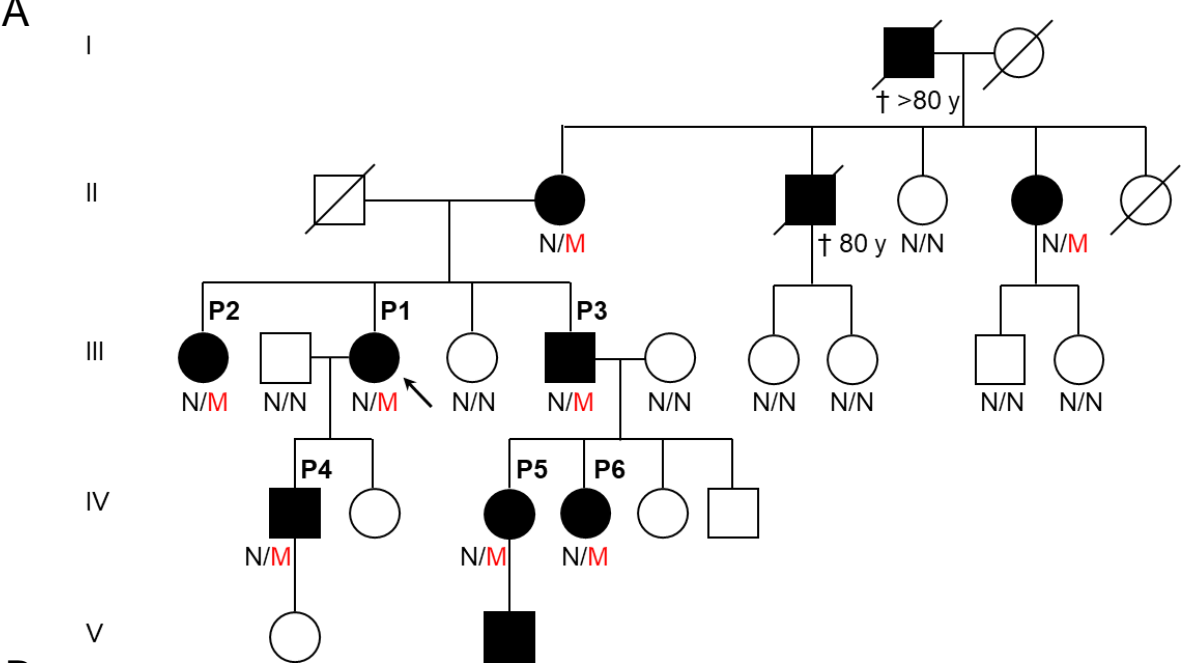
736

737 **Table E1. RNA-Seq analysis data from P1's and P2's monocytes.**

738

739 **Table E2. Proteomics data from immortalized B cells and HEK293T and obtained after**  
740 **RNF213 immunoprecipitation followed by NanoLC MS/MS.**

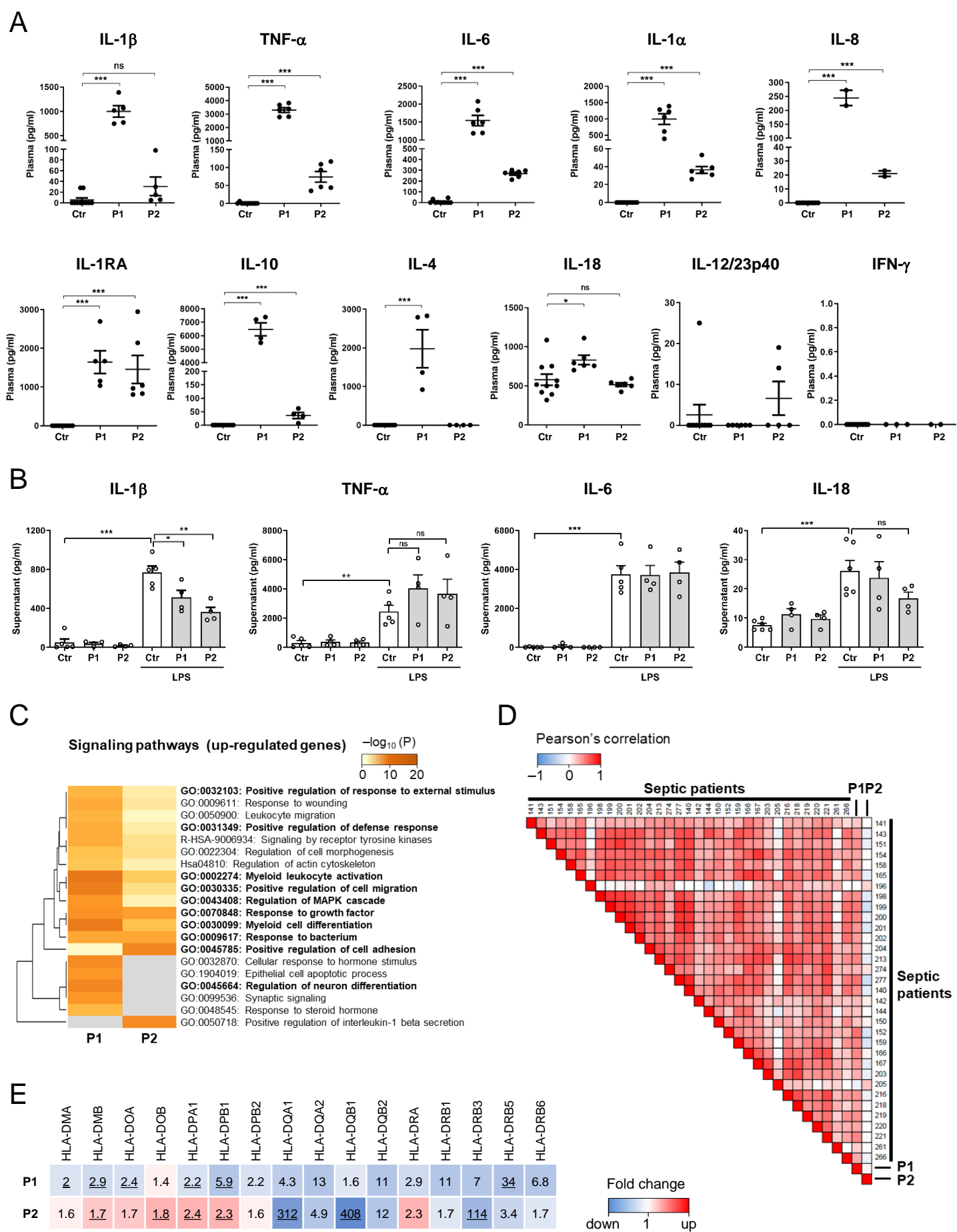
741



**C**

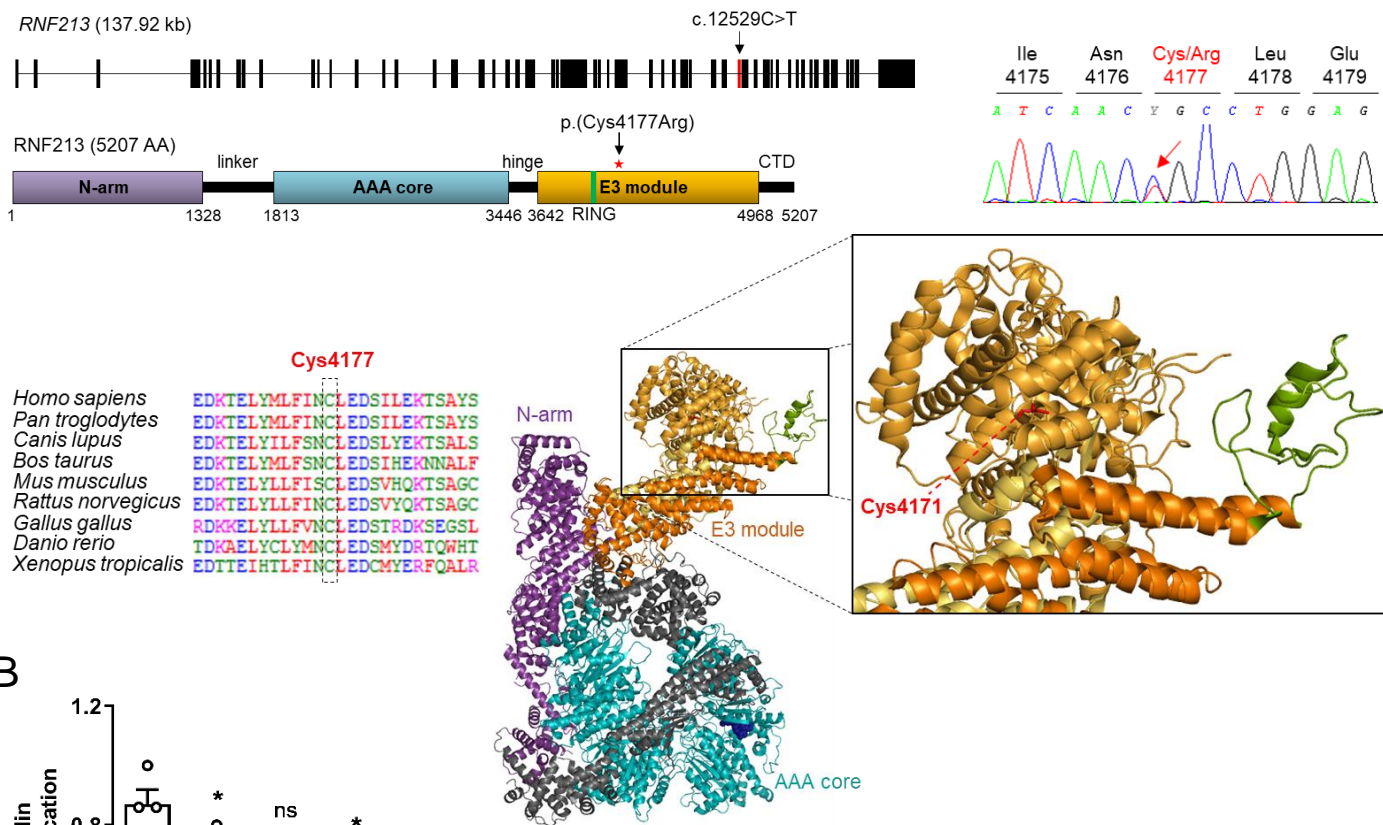
Patient	P1	P2	P3	P4	P5	P6
Age at onset (years)	12	1	5	0.5	20	14
Age at evaluation (years)	55	56	50	31	27	23
Urticarial lesions	yes	yes	yes	yes	yes	yes
Duration of flares	Continuous, winter aggravation	Several months, winter aggravation	Continuous, winter aggravation	Continuous, winter aggravation	5-7 days, in autumn/winter	2-3 weeks, in winter
Localisation	Face, back, cleavage, arms, legs	Arms, buttock	Back, arms, buttock	Arms, buttock, legs (thighs), ears	Arms, legs (calves, knees)	Back, legs (calves, knees)

**Figure 1**

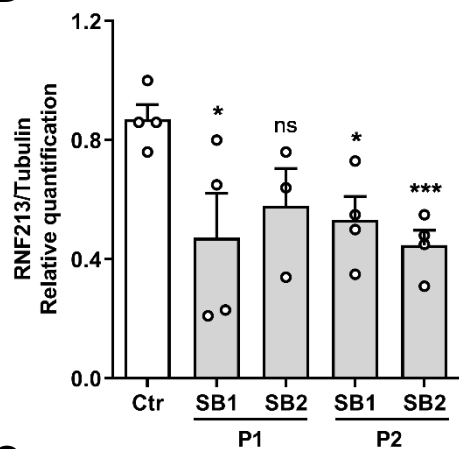


**Figure 2**

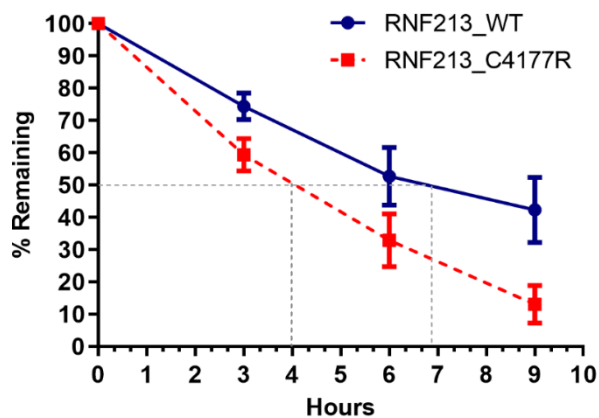
**A**



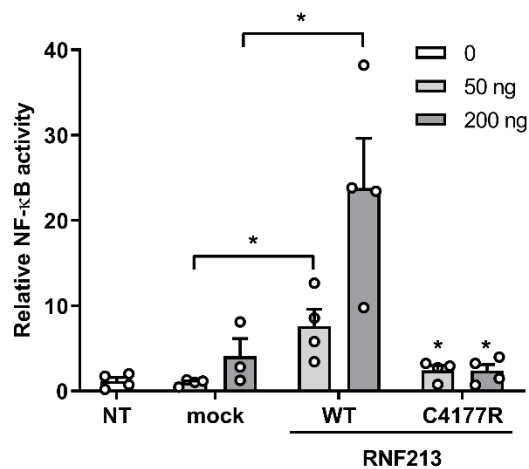
**B**



**C**

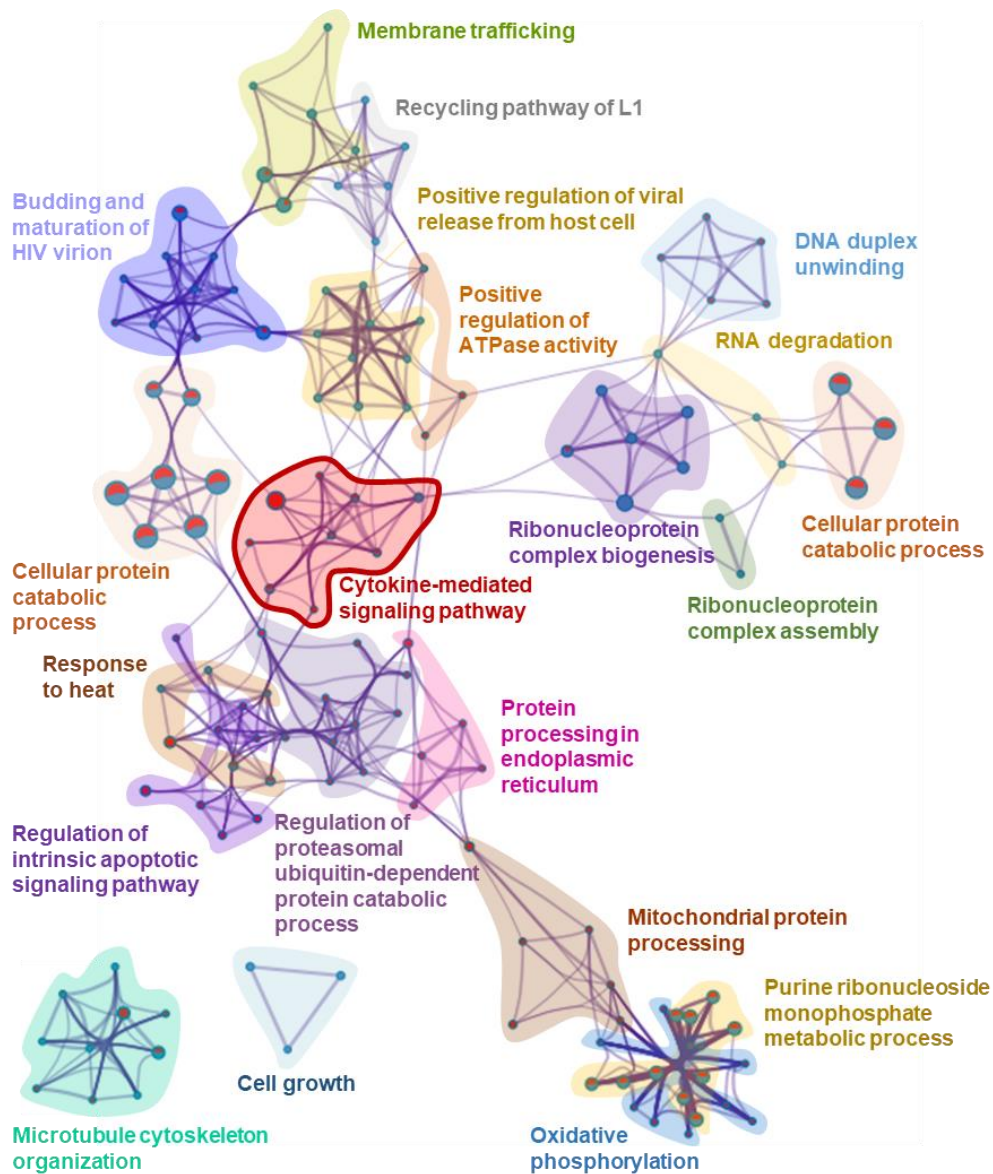


**D**



**Figure 3**

# A RNF213 interactions: enrichment analysis



# B Cytokine-mediated signaling pathway

Gene	Red	Blue
<b>CYLD</b>	Red	Blue
CAMK2D	Red	Blue
OAS2	Red	Blue
NUP50	Blue	Blue
PSMA2	Red	Blue
RRP1B	Blue	Blue
PSMB1	Red	Blue
LSM14A	Blue	Blue
ABCE1	Red	Blue
PSMD4	Blue	Blue
PSMB2	Red	Blue
ISG15	Blue	Blue
IGHG1	Red	Blue
KARS	Red	Blue
PTPN1	Red	Blue
ISG20	Blue	Blue
PSMA5	Red	Blue

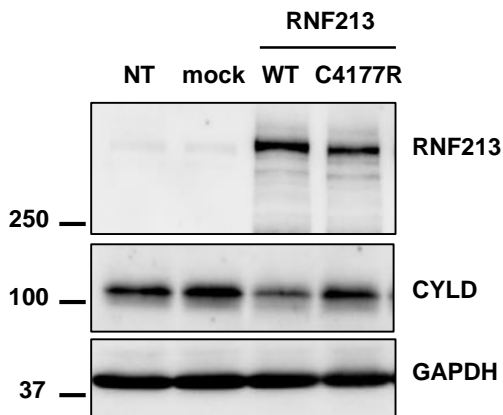
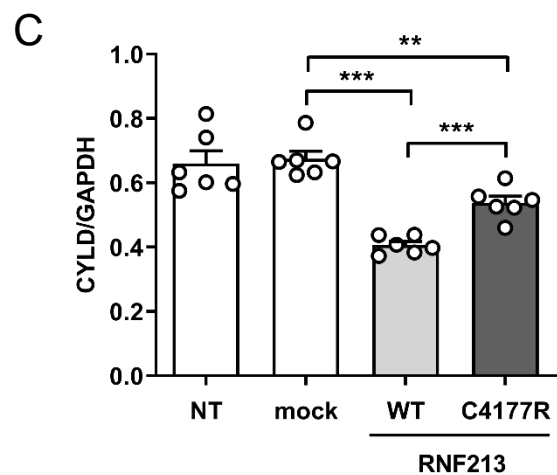
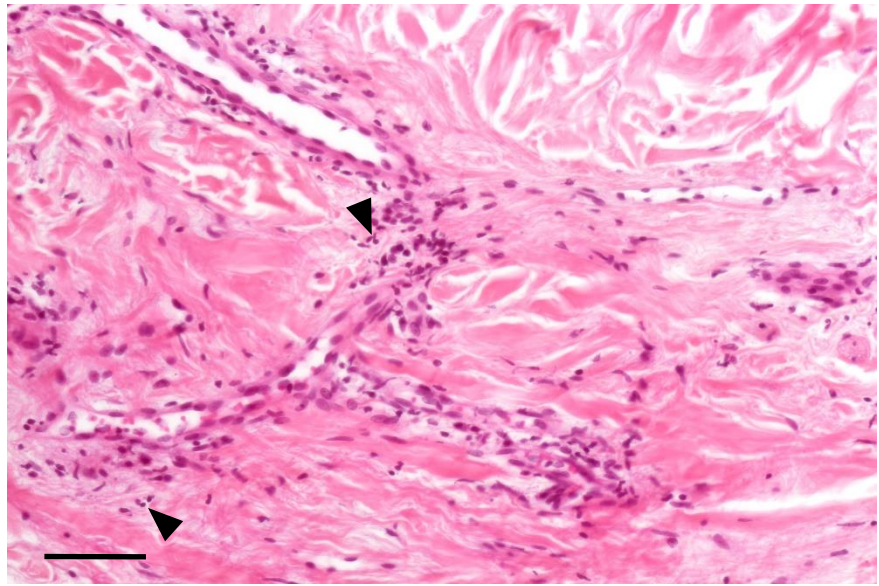
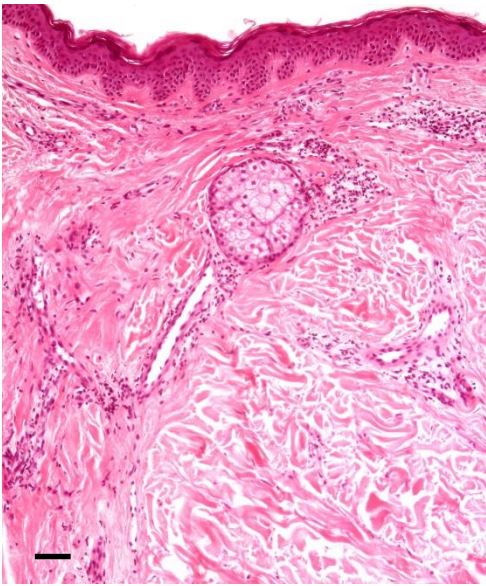
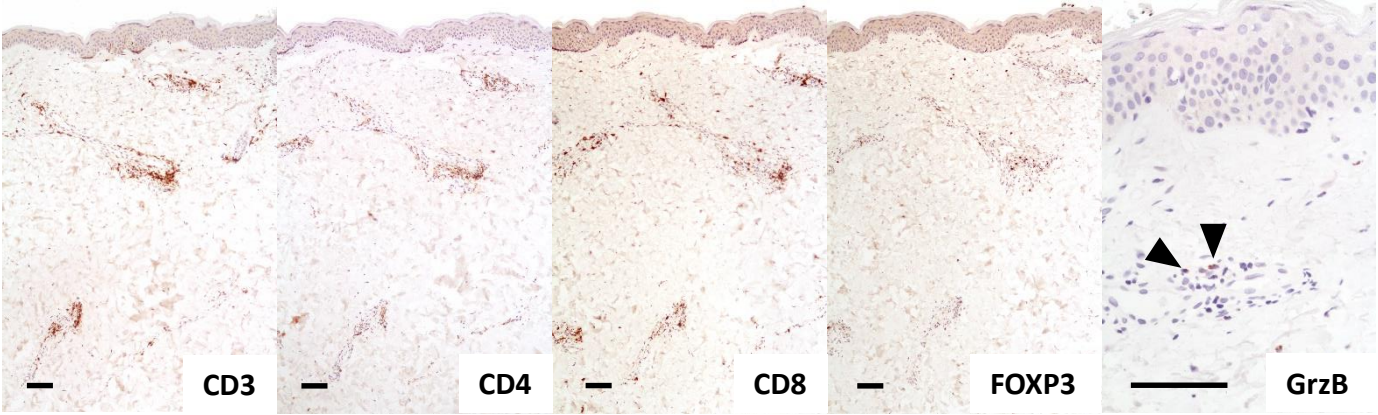


Figure 4

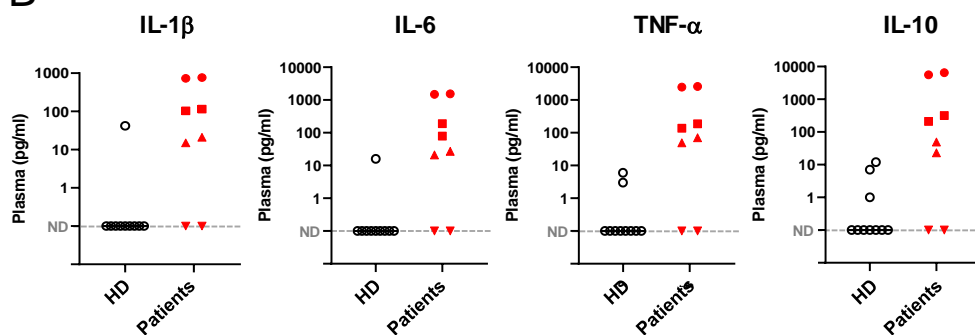
**A****B****Figure E1**



A

	P1	P2	P3	P4	P5	P6	Normal range
Hemoglobin (g/dl)	13.2	13.8	15.8	14.2	12.8	14.0	Females 11.5–17.5 Males 3.0–18.0
Leukocytes (G/l)	3.1	6.4	4.1	3.5	8.4	5.7	4.0–10.0
Platelets (G/l)	231	269	240	293	243	283	150–400
Total lymphocytes (G/l)	<b>0.6</b>	2.3	1.2	<b>0.95</b>	1.2	2.4	1.0–4.0
CD4+ (cells/ $\mu$ l)	<b>167</b>	<b>1347</b>	NA	NA	NA	NA	475–1050
CD8+ (cells/ $\mu$ l)	<b>167</b>	567	NA	NA	NA	NA	185–570
CD19+ (cells/ $\mu$ l)	79	<b>226</b>	NA	NA	NA	NA	50–150
Neutrophils (G/l)	2.0	3.3	2.3	2.2	6.6	2.7	1.5–7.0
Monocytes (G/l)	0.37	0.6	0.5	0.3	0.47	0.48	0.2–1.0
Eosinophils (G/l)	0.069	0.2	0.078	0.11	0.15	0.057	0.02–0.6
Basophils (G/l)	0.050	0	0.029	0.021	0.017	0.052	<0.11
CRP (mg/l)	2.5	2.5	2.2	0.6	2.6	0.9	<5.0
ESR (mm/h)	15	18	<b>16</b>	5	9	4	Females <19 Males <11
SAA (mg/l)	<b>15.6</b>	<b>9.4</b>	<b>7.7</b>	<6.4	<6.4	<6.4	<6.4
Total complement – CH50 (U/ml)	57	>60	>60	48	>60	>60	>32
C3 (g/l)	1.20	1.20	1.40	0.90	1.50	1.20	0.90–1.80
C4 (g/l)	0.15	0.22	0.17	0.15	0.17	0.15	0.10–0.40
Ferritin (ng/ml)	<b>292</b>	<b>192</b>	<b>1323</b>	216	22	<b>152</b>	Females 15–150 Males 30–400
LDH (U/l)	213	211	229	151	<b>296</b>	193	<250
IgA (g/l)	1.33	2.00	<b>4.29</b>	2.84	1.70	2.55	0.70–4.00
IgG (g/l)	15.96	13.62	15.53	15.16	12.12	13.98	7.00–16.00
IgM (g/l)	<b>0.37</b>	<b>0.33</b>	0.42	0.77	0.51	1.54	0.40–2.30
IgD (mg/l)	<13.00	<13.00	30.40	16.10	48.60	38.00	<132.10
IgE (UI/ml)	13.10	66.80	<b>288.00</b>	<b>118.00</b>	<b>329.00</b>	65.10	<114.00
Serum Tryptase ( $\mu$ g/l)	4.8	3.2	3.6	10.7	2.6	1.8	<11.4
Serum Calprotectin (mg/l)	0.62	<b>0.95</b>	NA	NA	NA	NA	<0.76
Antinuclear Abs aspect	<b>320</b> homogeneous and speckled	<b>320</b> homogeneous and speckled	<80	<b>160</b> speckled	<b>80</b> homogeneous and speckled	<80	<80
dsDNA Abs	Equivocal	Negative	NA	Negative	NA	NA	
ENA Abs panel	Negative	<b>SSB/La positive</b>	NA	Negative	NA	NA	

B



C

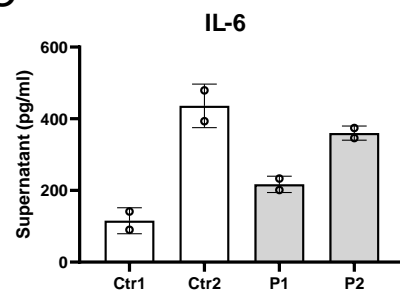


Figure E2

A

## Up-regulated genes

Signaling pathways: top 10	Log <sub>10</sub> (P)
Positive regulation of cell migration	-9.83
Myeloid leukocyte activation	-9.17
Response to bacterium	-9.16
Myeloid cell differentiation	-9.16
Response to growth factor	-8.70
Positive regulation of response to external stimulus	-7.69
Positive regulation of defense response	-7.54
Regulation of MAPK cascade	-7.47
Regulation of neuron differentiation	-7.32
Positive regulation of cell adhesion	-7.13

B

## Up-regulated genes

P1		P2	
Gene	FC	Gene	FC
<i>OLFM4</i>	263.09	<i>CLLU10S</i>	341.67
<i>LINC02470</i>	90.44	<i>TREML4</i>	74.44
<i>TREML4</i>	77.43	<i>HSPB7</i>	39.3
<i>RETN</i>	21.17	<i>BIRC7</i>	29.16
<i>CEACAM8</i>	14.27	<i>HTRA3</i>	18.84
<i>CD177</i>	13.55	<i>ULBP2</i>	11.3
<i>BPI</i>	11.32	<i>ADGRG1</i>	10.55
<i>ANXA3</i>	10.82	<i>CX3CR1</i>	9.85
<i>LCN2</i>	9.96	<i>NME8</i>	9.42
<i>IL6</i>	9.52	<i>S100B</i>	9.05
<i>STON2</i>	9.12	<i>GAL</i>	8.38
<i>PGLYRP1</i>	8.74	<i>LGR6</i>	8.31
<i>LTF</i>	8.38	<i>SLC22A23</i>	8.21
<i>GPRC5D-AS1</i>	7.83	<i>GPRC5D-AS1</i>	8.2
<i>HSPB7</i>	7.83	<i>CHIT1</i>	7.91
<i>CAMP</i>	7.08	<i>GALNT14</i>	7.61
<i>HPGD</i>	6.79	<i>FCRL6</i>	7.53
<i>GAL</i>	6.76	<i>TLN2</i>	7.4
<i>MMP8</i>	6.65	<i>NR1R</i>	7.17
<i>ARG1</i>	6.65	<i>MYEOV</i>	6.99

C

## Down-regulated genes

Signaling pathways: top 10	Log <sub>10</sub> (P)
Ribosome, cytoplasmic	-59.55
T-cell activation	-23.27
Hematopoietic cell lineage	-12.83
Adaptive immune response	-12.49
Alpha-beta T-cell activation	-11.20
T-cell selection	-9.27
Antigen receptor-mediated signaling pathway	-8.65
Ribosome assembly	-8.49
Leukocyte migration	-7.45
Lymphocyte costimulation	-6.53

## Signaling pathways (down-regulated genes)

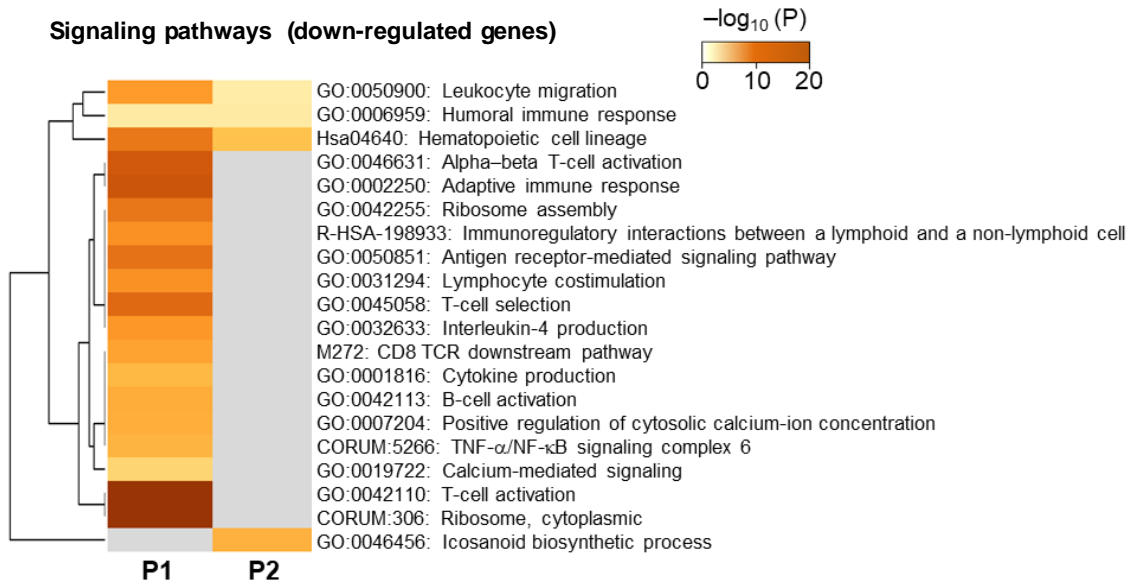
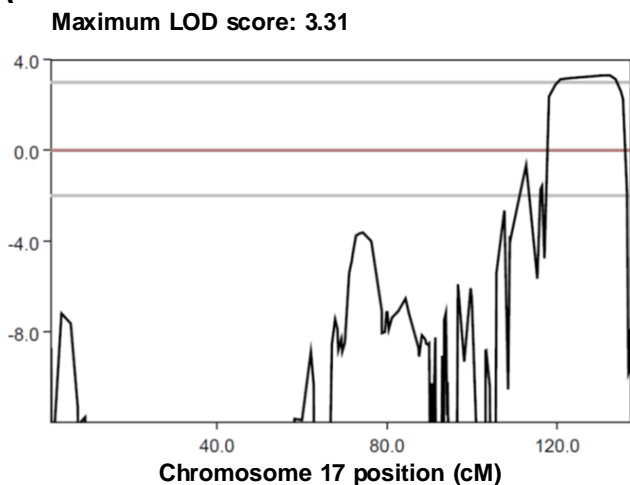
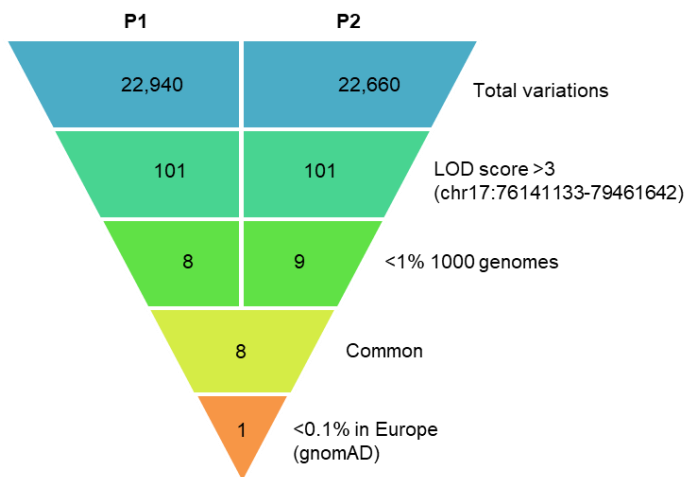


Figure E3

A



B



C

Variation	Genotype	gnomAD	gnomAD Europe
<i>DNAH17</i> (NM_173628) Exon 42, c.6462C>T p.(Ala2154Ala)	heterozygous	1718/278058	1293/127052 (1.02%)
<i>DNAH17</i> (NM_173628) Exon 26, c.4042C>T p.(Arg1348Cys)	heterozygous	573/280614	498/128386 (0.39%)
<i>USP36</i> (NM_025090) Exon 4, c.318C>A p.(Pro106Pro)	heterozygous	3117/282174	1878/128830 (1.46%)
<i>GAA</i> (NM_000152) Exon 4, c.858+5insGCAGCGG	homozygous	181917/274012 †	90918/123654 (73.5%)
<b><i>RNF213</i> (NM_001256071) Exon 47, c.12529T&gt;C p.(Cys4177Arg)</b>	<b>heterozygous</b>	<b>0</b>	<b>0</b>
<i>ENTHD2</i> (NM_144679) Exon 6, c.437G>T p.(Gly146Val)	heterozygous	2043/256456	1399/117278 (1.19%)
<i>SLC38A10</i> (NM_138570) Exon 14, c.2284_*1del	heterozygous	9488/241908	3049/114298 (2.67%)
<i>SLC38A10</i> (NM_001037984) Exon 11, c.1146C>T p.(Val382Val)	heterozygous	2385/275134	1514/124790 (1.21%)

† Frequent variation (different annotations).

D

***RNF213* c.12529T>C , p.(Cys4177Arg)**

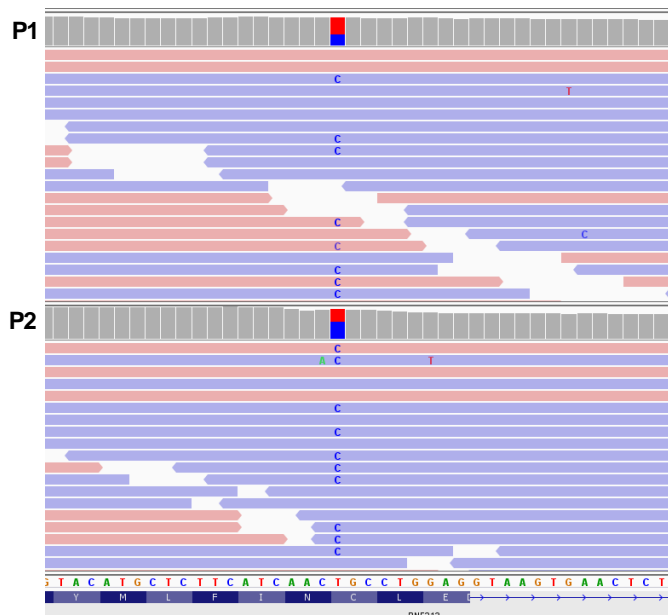
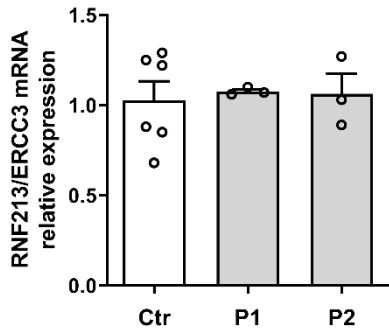
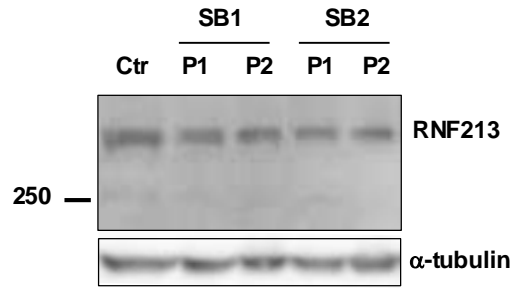
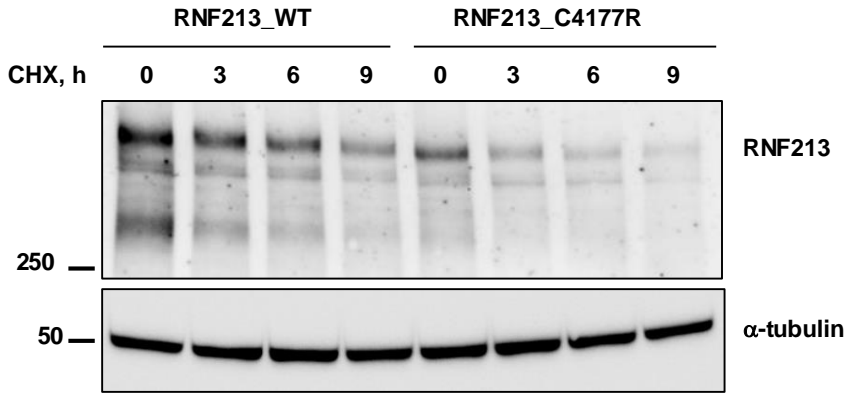
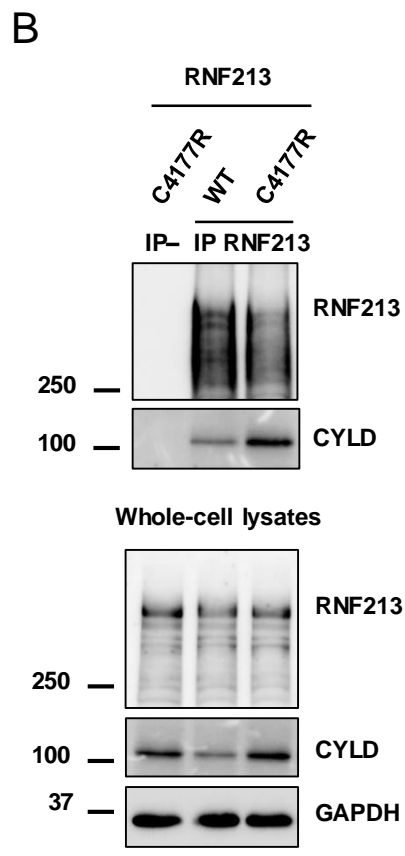
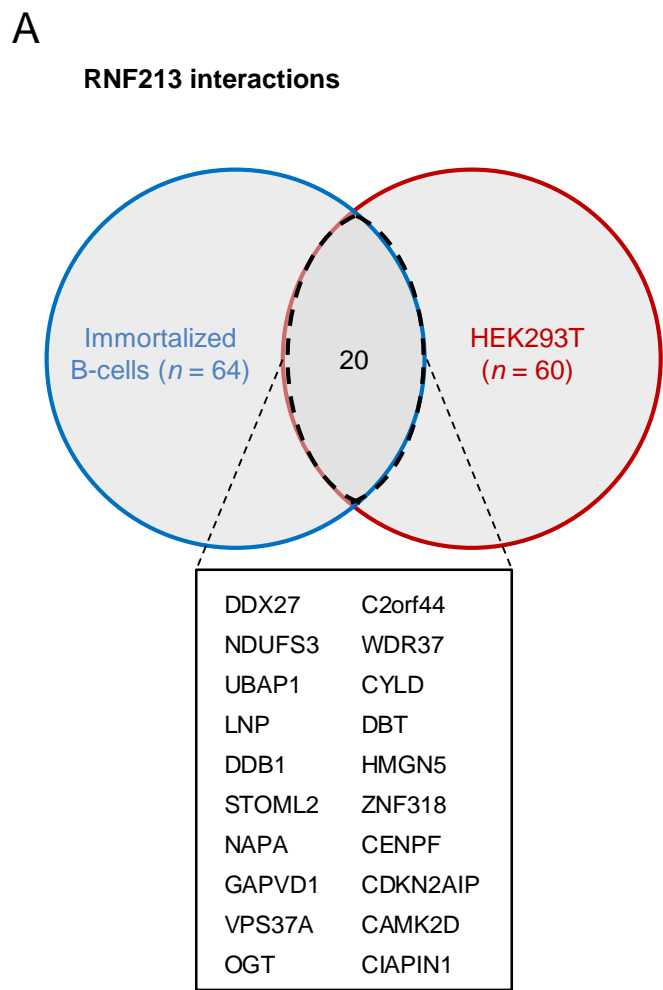


Figure E4

**A****B****C****Figure E5**



**Figure E6**