



HAL
open science

Assessing the cost-effectiveness of hepatitis C screening strategies in France

Sylvie Deuffic-Burban, Alexandre Huneau, Adeline Verleene, Cécile Brouard, Josiane Pillonel, Yann Le Strat, Sabrina Cossais, Françoise Roudot-Thoraval, Valérie Canva, Philippe Mathurin, et al.

► **To cite this version:**

Sylvie Deuffic-Burban, Alexandre Huneau, Adeline Verleene, Cécile Brouard, Josiane Pillonel, et al.. Assessing the cost-effectiveness of hepatitis C screening strategies in France. *Journal of Hepatology*, 2018, 69 (4), pp.785-792. 10.1016/j.jhep.2018.05.027 . inserm-02472188

HAL Id: inserm-02472188

<https://inserm.hal.science/inserm-02472188>

Submitted on 10 Feb 2020

HAL is a multi-disciplinary open access archive for the deposit and dissemination of scientific research documents, whether they are published or not. The documents may come from teaching and research institutions in France or abroad, or from public or private research centers.

L'archive ouverte pluridisciplinaire **HAL**, est destinée au dépôt et à la diffusion de documents scientifiques de niveau recherche, publiés ou non, émanant des établissements d'enseignement et de recherche français ou étrangers, des laboratoires publics ou privés.

Assessing the cost-effectiveness of hepatitis C screening strategies in France

Sylvie Deuffic-Burban^{1,2}, Alexandre Huneau¹, Adeline Verleene¹, Cécile Brouard³, Josiane Pillonel³, Yann Le Strat³, Sabrina Cossais¹, Françoise Roudot-Thoraval⁴, Valérie Canva⁵, Philippe Mathurin^{2,5}, Daniel Dhumeaux⁶, Yazdan Yazdanpanah^{1,7}

¹ IAME, UMR 1137, Inserm, Université Paris Diderot, Sorbonne Paris Cité, Paris, France

² Université Lille, Inserm, CHU Lille, U995 – LIRIC – Lille Inflammation Research International Center, Lille, France

³ Santé publique France, Saint-Maurice, France

⁴ Service Santé Publique, Hôpital Henri Mondor, Créteil, France

⁵ Service des Maladies de l'Appareil Digestif et de la Nutrition, Hôpital Huriez, CHRU Lille, Lille, France

⁶ Inserm U955, Hôpital Henri-Mondor, Créteil, France

⁷ Service de maladies Infectieuses et tropicales, Hôpital Bichat Claude Bernard, Paris, France

Corresponding author: Sylvie Deuffic-Burban, IAME UMR1137, Inserm, Université Paris Diderot et Paris Nord, UFR de Médecine Site Bichat, 16 rue Henri Huchard, 75018 Paris, France. Tel: 33 (0)1 57 27 75 34 - Fax: 33 (0)1 57 27 75 21, sylvie.burban@inserm.fr

Key words: chronic hepatitis C; cohort Markov model; effectiveness analysis; cost-effectiveness analysis; interferon-free direct-acting antiviral agents; screening

Electronic word count: 6,016

Number of figures and tables: 3 figures – 5 Tables

Financial support statement: This work was supported by the French Agence Nationale de Recherche sur le Sida et les Hépatites virales (ANRS, <http://www.anrs.fr/>).

Conflict of interest: Sylvie Deuffic-Burban reports having received research grants from Janssen and MSD; consultancy honoraria from Abbvie, Bristol-Myers Squibb, Gilead, and MSD; and lecture fees from Bristol-Myers Squibb and Gilead. Françoise Roudot-Thoraval reports having received consultancy honoraria from Gilead; and lectures fees from Bristol-Myers Squibb, Gilead, MSD, Janssen and AbbVie. Valérie Canva reports having received consultancy honoraria and lecture fees from Abbvie, Bristol-Myers Squibb, Janssen, Gilead and MSD. Philippe Mathurin reports having received consultancy honoraria from Abbvie, Bayer, Bristol-Myers Squibb, Gilead, MSD, Sanofi, and Verlyx; and lecture fees from Bayer, Bristol-Myers Squibb, Gilead, and MSD. Yazdan Yazdanpanah reports having received consultancy honoraria from Abbvie, Bristol-Myers Squibb, Gilead, MSD, Pfizer, Tibotec and ViiV Healthcare.

Authors contributions: SDB and YY have had the conception and design of the work. SDB, AH, AV, CB, JP, YLS and SC acquired the data. SDB performed the analysis. All authors contributed to interpretation of data. All authors participated to writing and revision of the paper, and approved the final version to be published.

Abstract (274 words)

Background and aims: In Europe, hepatitis C virus (HCV) screening still targets people at high risk of infection. We aim to determine the cost-effectiveness of expanded HCV screening in France.

Methods: A Markov model simulated chronic hepatitis C (CHC) prevalence, incidence of events, quality adjusted life years (QALYs), costs and incremental cost-effectiveness ratio (ICER) in the French general population, aged 18 to 80 years, undiagnosed for CHC for different strategies: S1=current strategy targeting the at risk population; S2=S1 and all men between 18 and 59 years; S3=S1 and all individuals between 40 and 59 years; S4=S1 and all individuals between 40 and 80 years; S5=all individuals between 18 and 80 years (universal screening). Once CHC diagnosed, treatment was initiated either to patients with fibrosis stage \geq F2 or regardless of fibrosis. Data were extracted from published literature, a national prevalence survey, and a previously published mathematical model. ICER were interpreted based on one or three times French GDP per capita (€32,800).

Results: Universal screening led to the lowest prevalence of CHC and incidence of events, regardless of treatment initiation. When considering treatment initiation to patients with fibrosis \geq F2, targeting all people aged 40-80 was the only cost-effective strategy at both thresholds (26,100€/QALY). When we considered treatment for all, although universal screening of all individuals 18-80 is associated with the highest costs, it is more effective than targeting all people 40-80 and cost-effective at both thresholds (31,100€/QALY).

Conclusions: In France, universal screening is the most effective strategy and is cost-effective when treatment is initiated regardless of fibrosis stage. From an individual and especially from a societal perspective of HCV eradication, this strategy should be certainly implemented.

Lay summary

- In the context of highly effective and well tolerated therapies that are now recommended for all patients, a reassessment of HCV screening strategies is needed.
- An effectiveness and cost-effectiveness study of different strategies targeting either the at risk population, specific ages or all individuals was performed.
- In France, universal screening is the most effective strategy and is cost-effective when treatment is initiated regardless of fibrosis stage. From an individual and especially from a societal perspective of HCV eradication, this strategy should be certainly implemented.

Introduction

In Europe, recommendations for hepatitis C virus (HCV) screening still target only people at high risk of infection [1]. With this screening strategy, around 40% of infections are still not detected in France [2]; around 75,000 individuals in 2014 [3].

The current situation is in favor of a reassessment of the screening strategy for several reasons: (i) hepatitis C is diagnosed at an advanced stage of the disease in more than one patient out of 10, corresponding to a delay in diagnosis [4, 5]; (ii) recent availability of highly efficacious and well tolerated treatments (i.e.; direct-acting antiviral (DAA)-based regimens) [6]; (iii) in addition to standard serological tests, rapid screening tests now exist for viral hepatitis C, that can help to expand the availability of screening outside health facilities, and to develop new strategies especially for those who have no access to interventions implemented in healthcare facilities [7]. Since 2012, the United States (US) and Canada have advocated one-time testing in specific birth cohorts, corresponding to those with the highest prevalence of hepatitis C [8-10]. It is however not clear that these strategies are applicable to other countries with different HCV epidemiological profile. In addition, the cost-effectiveness analyses underlying these strategies were conducted with past treatments that were much less effective than present DAA.

Although France is one of the countries with the highest HCV screening level, the impact of treatment may be increased with improvement in HCV detection and therapeutic management [11]. Early detection can allow earlier introduction of antiviral treatment leading to a reduction in morbidity and mortality [12]. It can also allow a reduction in the cost of care, because an effective and early treatment may prevent progression to the costly complications, such as cirrhosis and/or hepatocellular carcinoma [13]. Finally it can have a societal benefit because testing and treatment of hepatitis in particular in at risk population may avoid HCV

transmission and help control HCV epidemic [14]. Currently, in France, a group of experts designed by the ministry of health to elaborate recommendations on HCV care and optimization of screening recommended universal screening for hepatitis C for the purpose of elimination [15]. However, universal screening – and how to launch it – is not yet decided to be funded by the Ministry of Health and by the Haute Autorité de la Santé.

The objective of this study is to evaluate the effectiveness, cost and cost-effectiveness of different hepatitis C screening strategies to guide the public authorities in the reassessment of the screening policy.

Materials and Methods

Study design

We designed a decision analysis model to evaluate life expectancy, life expectancy in discounted quality adjusted life years (QALYs), direct lifetime discounted costs and incremental cost-effectiveness ratio (ICER) for five different HCV screening strategies among the French 18-80 general population undiagnosed for chronic hepatitis C (CHC, HCV-RNA positive individuals): S1=current strategy: HCV screening is only offered to high-risk individuals identified through an imperfect assessment of their risk factors; S2=S1 and all men between 18 and 59 years; S3=S1 and all individuals between 40 and 59 years; S4=S1 and all individuals between 40 and 80 years; S5=all individuals between 18 and 80 years. Once CHC diagnosed, treatment was initiated either to patients with fibrosis stage \geq F2 or regardless of fibrosis. We also estimated the impact of each strategy, first in terms of CHC prevalence one year later among the undiagnosed general population and, second, in terms of cumulated incidence of cirrhosis (F4), decompensated cirrhosis, HCC and liver-related deaths at 10 and 20 years among the CHC population.

The ICER between two strategies was defined as the additional cost of a specific strategy compared with the next least expensive strategy, divided by its additional clinical benefit. Strategies were considered inefficient and excluded from ICER calculations if they resulted in higher costs but less of benefit, or had a higher ICER than a more effective strategy [16]. We adopted a modified_societal perspective excluding indirect costs [17]. We used a lifetime horizon of 50 years and discounted all future costs and clinical benefits at 4% per year over the first 30 years, decreasing from 4% to 2% thereafter, based on French guidelines for cost-effectiveness analysis [17]. Costs were expressed in 2017 Euro (€). Given that no threshold is defined by French Health Authorities, we used the GDP per capita (€32,800 in 2015 [18]) for

interpreting the ICER, following the WHO's Commission on Macroeconomics and Health [19]: interventions that have an ICER of less than three times GDP per capita are considered as cost-effective (i.e. willingness to pay (WTP) of €98,400), and those that have an ICER of less than one times GDP per capita as very cost-effective (i.e. a WTP of €32,800). As the threshold of €98,400 can be considered too high and contestable, we interpreted our results according to both thresholds [20].

Model structure

A testing decision tree was combined with a previously published Markov-based model to simulate the trajectory of all individuals according to each testing strategy (Supplementary material) [21]. For those screened for CHC and eligible for treatment, treatment was introduced into the natural course of the disease.

Input parameter for the models

Study population

The study population consisted of the French general population aged 18 to 80 years, without any known diagnosis of HCV-RNA positivity. Characteristics of this population were issued from the 2004 national seroprevalence survey of the French National Public Health agency [2, 3]. First, we obtained the estimated proportion of CHC (HCV-RNA positivity) in this study population according to the presence or absence of risk factors (Table 1). Accordingly, the estimated prevalence of CHC among French undiagnosed 18-80 general population was 0.23%. Second, in the risk-based strategy, individuals were assumed to be tested as observed in the 2004 French survey, i.e. between 4% and 18% for individuals without risk factors and

between 10% and 19% for those with risk factors (Table 2). For the new screening strategies, we assumed that 50% of targeted individuals were tested. Third, because excessive alcohol abuse was recognized as a risk factor of CHC progression [22], we obtained the distribution of excessive alcohol abuse by gender and age using a previously published model [23], i.e. in males: 26% in 18-39, 18% in 40-59 and 3% in 60-80; in females: 6%, 4% and 2%, respectively. Finally, our previous modeling was also used to stratify the study population into fibrosis stage (Supplementary Table 3) [23]. More details are provided in Supplementary material.

Virological response rate

The probabilities of SVR considered were: 95% in stages of fibrosis F0 to F4, 85% in decompensated cirrhosis [24]. Patients who achieved a sustained virological response (SVR) to treatment at different stages of fibrosis before cirrhosis (F4) no longer had fibrosis progression. In contrast, patients who showed a SVR at stage F4 remained at risk of developing complications and death, but at lower risks as obtained with past IFN-based treatment [25]. Because of lack of data and to remain conservative, patients who achieved a SVR in decompensated cirrhosis were considered to have the same risk of progression as that of untreated patients. In patients who did not achieve SVR, fibrosis progression was considered the same as that of untreated patients.

Costs

We included direct medical lifetime costs associated with HCV screening, and HCV disease treatment and care, as previously described [26] (Supplementary Material and Supplementary Table 4). Following the French treatment recommendations and recent negotiations of drug prices, we have considered a unique price of 28,730€ for a 12-week DAA cure, with the exception of patient with decompensated cirrhosis receiving also 12 weeks of ribavirin [27,

28], leading to a total cost of 29,615€. In the baseline analysis, we did not consider any cost related to treatment-related adverse events. This was varied in sensitivity analysis.

Health-related quality of life

EuroQol-5D was used to evaluate health utility in CHC patients with use of French Time-Trade-Off value set: 0.82 when fibrosis \leq F2 and 0.76 when fibrosis F3-4 prior treatment, 0.60 for decompensated and HCC patients, 0.55 for the first year and 0.82 for subsequent years after liver transplantation (Supplementary Material) [29]. Health utilities were increased to 0.95 and 0.85 after SVR for F0-1 and for F2-4, respectively, as observed in Adelphi study [30]. Health utilities were remained unchanged after SVR in decompensated cirrhosis.

Sensitivity analysis

An extensive sensitivity analysis was conducted to evaluate the impact of assumptions or uncertainties around the data on the cost-effectiveness analysis considering only the case of treatment for all, and to determine the robustness of our overall conclusions (Supplementary Material). Firstly, we performed a one-way deterministic sensitivity analysis, varying values of input parameters that may change our conclusions. In order to take into account the limits of the utility data set used, we also conducted the analysis from Canadian data often cited in the literature and based on Euro-Qol-5D [31]. We also changed the distribution of the study population – i.e. the French general population aged 18 to 80 years, without any known diagnosis of HCV-RNA positivity – according to gender and age-group, so as the gender- and age-distribution of undiagnosed chronically-infected HCV population to be consistent with estimates of Brouard et al [3]. We also performed an analysis considering costs related to severe anemia leading to transfusion for patients initiating ribavirin. Finally, we considered a

delay of one year after diagnosis before treatment initiation. Secondly, we performed probabilistic sensitivity analysis using 1000 second-order samples of the parameters (Supplementary Material).

Software

The model was analyzed with TreeAge Pro 2017 suite software (Williamstown, MA, USA).

Results

Baseline analysis

When considering treatment initiation to patients with fibrosis stage \geq F2, CHC prevalence among the 18-80 undiagnosed general population decreased after a year from 0.23% to 0.17-0.21% according to the strategy, and to 0.12-0.20% when considering treatment for all, i.e. regardless of fibrosis stage (**Fig. 1.**).

Fig. 2. reported effectiveness results of the different HCV screening strategies in terms of cumulated incidence of cirrhosis F4, decompensated cirrhosis, HCC and liver-related deaths among CHC population after 10 (**Fig. 2A.**) and 20 years (**Fig. 2B.**). The most effective strategy is universal screening of individuals between 18 and 80 years leading to the lowest incidences of events: as an example, 2.36% for cirrhosis, 1.92% for decompensated cirrhosis, 2.34% for HCC and 5.28% for liver deaths after 20 years, compared to 3.03%, 2.29%, 2.54% and 5.76%, respectively, with the current strategy (risk-based).

Table 3 reported results of the cost-effectiveness baseline analysis of different HCV screening strategies. Either by initiating DAAs combination to patients with fibrosis stage \geq F2 or regardless of fibrosis, the current strategy was the cheapest but also the least effective. When treatment was initiated to patients with fibrosis stage \geq F2, adding the screening of all people aged 40-59 years or of all men between 18 and 59 years was dominated. Targeting all people aged 40-80 was the only cost-effective strategy at both WTP thresholds (€26,100 per QALY gained), leading to save an average of 0.05 LYs and 0.05 QALYs among CHC patients compared to the current strategy. Universal screening was the most effective strategy leading to save among CHC patients an average of 0.06 LYs and 0.07 QALYs compared to the current strategy. However this strategy was not cost-effective (€147,200 per QALY gained). When we considered treatment for all (**Fig. 3A.**), adding all men aged 18-59 years to the

current screening strategy was dominated. Targeting all people aged 40-80 was associated with the lowest ICER (21,400€/QALY) leading this strategy to be cost-effective at both WTP thresholds. Although associated to the highest costs, universal screening was even more effective than targeting all people 40-80 and remained cost-effective (31,100€/QALY) at both WTP thresholds.

Sensitivity analysis

During deterministic cost-effectiveness analysis, when we considered treatment for all, varying values of input parameters or assumptions did not affect our main results (Supplementary Tables 7-22), with some exceptions. First, when we changed utility data, universal strategy was no more cost-effective at a WTP of one time GDP per capita but remained cost-effective strategy at a WTP of three times GDP per capita (ICER at 59,200€/QALY compared to the strategy targeting all people 40-80) (Table 4). By contrast, when we varied the post-SVR utility gains and assumed no benefit, universal screening strategy was no more cost-effective (Table 4). Second, when we varied the assumption regarding the immediate initiation of treatment after diagnosis, considering a delay of one year after diagnosis before treatment initiation, universal screening is again the most effective but no more cost-effective (Table 5). Adding all men aged 18-59 to current screening strategy becomes the only cost-effective strategy at both WTP (ICER at 32,800€/QALY compared to the current strategy). Third, when we increased cost of screening tests by 20%, universal screening remained cost-effective at a WTP of three times GDP per capita but no more cost-effective at a WTP of one time GDP per capita (ICER at 36,300€/QALY compared to the strategy targeting all people 40-80) (Supplementary Table 15). Moreover, when we combined an increase in screening uptake from 50% to 100% and in cost of screening tests from 0% to

20%, the average lifetime cost for universal screening increased from 84.92 to 100.24€ per person and ICER increased from 31,100 to 36,700€/QALY compared to the strategy targeting all 40-80 (Supplementary Table 22). Again, universal screening remained cost-effective over the entire range of variation at a WTP of one time GDP per capita or slightly above that threshold while being below the threshold of three times GDP per capita. Finally, when we changed the distribution of the study population, universal strategy was again no more cost-effective at a WTP of one time GDP per capita but remained cost-effective strategy at a WTP of three times GDP per capita (ICER at 54,500€/QALY compared to the strategy targeting all people 40-80) (Supplementary Table 20).

Using probabilistic sensitivity analysis, we estimated that universal screening was cost-effective with 24% probability at a WTP of one time GDP per capita and 68% probability at a WTP of three times GDP per capita (**Fig. 3B.**).

Discussion

This study evaluated the effectiveness, cost and cost-effectiveness of different HCV screening strategies in France. First, current screening based on risk-factors was associated to the lowest life expectancy and QALYs. Second, adding the screening of individuals with specific age and/or gender to the current strategy increased effectiveness but also costs. Universal screening was associated to the highest life expectancy and QALYs but was not cost-effective under the scenario of initiating treatment to individuals with fibrosis stage \geq F2; the only cost-effective strategy being the addition of all individuals aged 40-80 to the current strategy under this scenario whether considering a WTP of three or one times GDP per capita. However, when we considered the treatment for all scenario, universal screening was associated to the highest effectiveness and became a cost-effective strategy at both thresholds, compared to the addition of all individuals aged 40-80.

Our study was conducted following the first French report for recommendations on the management of patients with hepatitis C or B virus [32]. Given the limits reached by the current screening strategy based on risk factors, an expert panel was established in France to develop new recommendations for HCV testing [33]. Data of HCV-undiagnosed people from the 2004 seroprevalence survey [2] showed that 55% of all of HCV undiagnosed people in 2004 are men aged 18-59 years [3]. The proportion of HIV and HBV undiagnosed patients who were men were even higher. Based on these considerations, and also to facilitate implementation of the general population screening in particular among general practitioner, the expert panel recommended first targeting all men aged 18-59 years at least once in their life as a complement to current risk-based testing and considering jointly HBV, HCV and HIV [32]. Our cost-effectiveness analysis for HCV screening showed indeed that this population-based screening strategy would be more effective than the current one. However

we also found that universal screening would be even more effective. Cost-effectiveness results were in part related on utility data and on whether treatment would be initiated at stage of fibrosis \geq F2 or regardless of fibrosis stage. Indeed the cost-effectiveness of a screening strategy is strongly linked to the stage of the disease at the time of treatment initiation.

Universal screening is cost-effective if treatment is started at an early stage of infection but is no longer effective if treatment is started in advanced stages of fibrosis. Also, when considering one year between diagnosis and treatment initiation, universal screening was no more cost-effective. This can be explained by a higher loss of effectiveness especially in older individuals when compared to a strategy targeting a younger population, while the cost of the universal screening remained higher. This means that a recommendation for a universal screening strategy must be accompanied by a recommendation for rapid initiation of treatment for all. Based on these results, the most recent French recommendations call for extending HCV screening to all adults [15]. However, in France, it is the Haute Autorité de la Santé that enlightens public authorities on decisions of recommendations and refund of the medical products and services. To date, the HAS has not changed its recommendations for hepatitis C screening but is currently considering our study in light of future recommendations. We can expect a decision in favor of universal screening, in addition to the reinforcement of targeted testing, as has been done for HIV [34].

These discrepancies between cost-effectiveness results when we concern different treatment initiation criteria can be explained as follow. When considering targeted treatment to fibrosis stage \geq F2, adding the screening of all individuals aged 40-80 to the current strategy would be effective and the only cost-effective strategy, for at least two combined reasons. First, it led to reach age classes with the highest CHC prevalence; namely those over 60 years of age [3]. Second, adding the screening of all individuals aged 40-80 to the current strategy allowed optimizing the screening of those that would be eligible for therapy. Indeed, the large majority

of patients aged 18-39 are in fibrosis stage F0F1 and are not eligible (Supplementary Table 3) [23]. As a result screening of these patients if treatment is not initiated immediately is less interesting. By contrast, when considering treatment for all with IFN-free DAA-based regimen as it is now implemented in France, universal screening became also a cost-effective strategy and was the most effective one.

Outside France, HCV screening was extended to birth cohorts in 2012 in the US. Since the highest incidence of HCV was found in people born between the years 1945-1965, both the CDC and the United States public health task force recommended one-time testing for anti-HCV for people born within this two decade period [8, 35]. Indeed, this strategy was found to be cost-effective at \$35,700 per QALY compared to risk-based strategy when considering treatment with interferon-based DAAs after screening [36]. Alternative evaluations confirmed that broader screening for HCV (1945-1965 or 1946-1970 birth-cohorts, general population aged 20-69 years) was cost-effective in the US compared to risk-based [37-40], and emphasized that screening only high-risk birth cohorts may be more cost-effective than screening the general population [38]. One main difference with our study is that those analyses conducted in the USA considered either dual therapy with peginterferon and ribavirin or triple therapy adding a protease inhibitor whom efficacy was lower and side effects higher than current IFN-free DAAs. They also emphasized that the benefits of screening increased with increasing treatment eligibility and efficacy. More recent cost-effectiveness evaluations were conducted in the US showing that universal screening was more cost-effective than the current birth cohort recommendations [41, 42]. In Canada, when treating with past dual or triple therapy, screening of the general population was only found to be cost-effective in targeting sub-populations with high HCV prevalence [43]. Even if a more recent analysis suggested that a selective one-time HCV screening program for people 25–64 would likely be cost-effective [44], the Canadian Task Force on Preventive Health Care

recommended testing only individuals at elevated risk of HCV arguing that the HCV prevalence in the general Canadian population is low (0.8%, i.e. four times lower than in the US in 1945-1965 birth cohorts) and direct evidence examining the benefits and harms of general screening for HCV is not available [45].

Our work has some limitations. First, we used a mathematical model relying on input data from multiple sources. Second, our baseline analysis was based on limited data for health-related utility, in particular regarding the utility benefit from achieving SVR. Using an alternative utility data set often cited in the literature [31], universal strategy remained cost-effective at a WTP between one to three times GDP per capita. However, it was no longer considering no utility benefit from achieving SVR, which seems unlikely [46]. Third, once CHC diagnosed, treatment was initiated either to patients with fibrosis stage \geq F2 or regardless of fibrosis, assuming a perfect linkage-to care of diagnosed individuals. However, varying proportion of treatment initiation between 50 and 100% did not affect our main results. Fourth, we based our model of the last French seroprevalence survey reflecting the year 2004. We took into account that this population may have changed given the evolution of HCV screening and HCV-RNA prevalence among undiagnosed individuals. However, again, we have varied our assumptions and universal strategy remained cost-effective at a WTP between one to three times GDP per capita. Fifth, as a conservative assumption, we based our analyses on listed prices of drugs. It is common that negotiated real prices are often lower, but these prices are unknown. It means that universal screening with treatment for all may be even more cost-effective. Sixth, conservatively again, we did not consider the impact of treatments on comorbidities and the possible reduction of the competitive mortality after SVR as well as the reduction of HCV transmission following HCV screening and treatment. Cousien et al illustrated the high effectiveness and cost-effectiveness of improving both testing and linkage to care together with a universal treatment in reducing HCV transmission in people who inject

drugs [47]. It means that universal screening should be even more cost-effective when considering its impact of HCV transmission. Finally, this work was based on French data and the French health system, but can be adapted to other countries.

In conclusion, in France, when considering treatment for all, universal screening of all individuals 18-80 is the most effective and a cost-effective strategy. From an individual and especially from a societal perspective of HCV eradication, this strategy should be certainly implemented. However, when recommending such strategy, rapid initiation of treatment after diagnosis is required.

References

- [1] European Centre for Disease Prevention and Control. Hepatitis B and C in the EU neighbourhood: prevalence, burden of disease and screening policies. Stockholm: ECDC; 2010.
- [2] Meffre C, Le Strat Y, Delarocque-Astagneau E, Dubois F, Antona D, Lemasson JM, et al. Prevalence of hepatitis B and hepatitis C virus infections in France in 2004: social factors are important predictors after adjusting for known risk factors. *J Med Virol* 2010;82:546-555.
- [3] Brouard C, Le Strat Y, Larsen C, Jauffret-Roustide M, Lot F, Pillonel J. The undiagnosed chronically-infected HCV population in France. Implications for expanded testing recommendations in 2014. *PLoS One* 2015;10:e0126920.
- [4] Delarocque-Astagneau E, Meffre C, Dubois F, Pioche C, Le Strat Y, Roudot-Thoraval F, et al. The impact of the prevention programme of hepatitis C over more than a decade: the French experience. *J Viral Hepat* 2010;17:435-443.
- [5] Brouard C, Delarocque Astagneau E, Meffre C, Pioche C, Silvain C, Larsen C, et al. Trends of hepatitis C screening in France through Rena-VHC and hepatology reference centres surveillance system, 2000-2007. *Bull Epidemiol Hebd* 2009;20-21:199-204.
- [6] Arends JE, Kracht PA, Hoepelman AI, on behalf of the European Study Group for Viral Hepatitis (ESGVH). Performance of hepatitis C virus (HCV) direct-acting antivirals in clinical trials and daily practice. *Clin Microbiol Infect* 2016;22:846-852.
- [7] Chevaliez S, Poiteau L, Rosa I, Soulier A, Roudot-Thoraval F, Laperche S, et al. Prospective assessment of rapid diagnostic tests for the detection of antibodies to hepatitis C virus, a tool for improving access to care. *Clin Microbiol Infect* 2016;22:459 e451-456.
- [8] Smith BD, Morgan RL, Beckett GA, Falck-Ytter Y, Holtzman D, Ward JW. Hepatitis C virus testing of persons born during 1945-1965: recommendations from the Centers for Disease Control and Prevention. *Ann Intern Med* 2012;157:817-822.

- [9] Grebely J, Bilodeau M, Feld JJ, Bruneau J, Fischer B, Raven JF, et al. The Second Canadian Symposium on hepatitis C virus: a call to action. *Canadian Journal of Gastroenterology* 2013;27:627-632.
- [10] Canadian Liver Foundation. Position statement - hepatitis C testing; 2012.
- [11] Deuffic-Burban S, Deltenre P, Buti M, Stroffolini T, Parkes J, Muhlberger N, et al. Predicted effects of treatment for HCV infection vary among European countries. *Gastroenterology* 2012;143:974-985 e914.
- [12] Deuffic-Burban S, Boursier J, Leroy V, Yazdanpanah Y, Castera L, Mathurin P. Are targeted treatment recommendations in chronic hepatitis C tailored to diagnostic methods of fibrosis? *J Hepatol* 2017;66:304-312.
- [13] Schwarzinger M, Deuffic-Burban S, Mallet V, Pol S, Pageaux GP, Canva-Delcambre V, et al. Lifetime costs attributable to chronic hepatitis C from the French healthcare perspective (Anrs N°12188). *J Hepatol* 2013;58:S21-22.
- [14] Cousien A, Tran VC, Deuffic-Burban S, Jauffret-Roustide M, Dhersin JS, Yazdanpanah Y. Hepatitis C treatment as prevention of viral transmission and liver-related morbidity in persons who inject drugs. *Hepatology* 2016;63:1090-1101.
- [15] Prise en charge thérapeutique et suivi de l'ensemble des personnes infectées par le virus de l'hépatite C. Rapport de recommandations 2016: Sous la direction du Pr Daniel Dhumeaux. Sous l'égide de l'ANRS et du CNS et avec le concours de l'AFEF.
- [16] Gold MR, Siegel JE, Russell LB, Weinstein MC. Cost effectiveness in health and medicine. New-York: Oxford University Press; 1996.
- [17] HAS Haute Autorité de Santé. Guide méthodologique : Choix méthodologiques pour l'évaluation économique à la HAS. Octobre 2011: Haute Autorité de Santé; 2011.
- [18] Index mundi. World GDP - per capita (PPP). [cited 12 February 2018]; Available from: [https://www.indexmundi.com/world/gdp_per_capita_\(ppp\).html](https://www.indexmundi.com/world/gdp_per_capita_(ppp).html)

- [19] WHO. Making choices in health: WHO guide to cost-effectiveness analysis. Geneva: WHO; 2003.
- [20] Neumann PJ, Cohen JT, Weinstein MC. Updating cost-effectiveness--the curious resilience of the \$50,000-per-QALY threshold. *N Engl J Med* 2014;371:796-797.
- [21] Deuffic-Burban S, Obach D, Canva V, Pol S, Roudot-Thoraval F, Dhumeaux D, et al. Cost-effectiveness and budget impact of interferon-free direct-acting antiviral-based regimens for hepatitis C treatment: the French case. *J Viral Hepat* 2016;23:767-779.
- [22] Corrao G, Arico S. Independent and combined action of hepatitis C virus infection and alcohol consumption on the risk of symptomatic liver cirrhosis. *Hepatology* 1998;27:914-919.
- [23] Deuffic-Burban S, Mathurin P, Pol S, Larsen C, Roudot-Thoraval F, Desenclos JC, et al. Impact of hepatitis C triple therapy availability upon the number of patients to be treated and associated costs in France: a model-based analysis. *Gut* 2012;61:290-296.
- [24] European Association for the Study of the Liver. EASL Recommendations on Treatment of Hepatitis C 2016. *J Hepatol* 2017;66:153-194.
- [25] van der Meer AJ, Veldt BJ, Feld JJ, Wedemeyer H, Dufour JF, Lammert F, et al. Association between sustained virological response and all-cause mortality among patients with chronic hepatitis C and advanced hepatic fibrosis. *JAMA* 2012;308:2584-2593.
- [26] Deuffic-Burban S, Schwarzinger M, Obach D, Mallet V, Pol S, Pageaux GP, et al. Should we await IFN-free regimens to treat HCV genotype 1 treatment-naive patients? A cost-effectiveness analysis (ANRS 95141). *J Hepatol* 2014;61:7-14.
- [27] AFEF. Recommandations AFEF sur la prise en charge de l'hépatite virale C: Société Française d'Hépatologie; 2017 Mars 2017.
- [28] Ministère des Affaires sociales et de la Santé. Accès universel aux traitements innovants contre l'hépatite C : Après avoir permis l'accès de tous les malades aux traitements, Marisol Touraine obtient une baisse de prix importante. Paris.

- [29] Chevalier J, de Pourville G. Valuing EQ-5D using time trade-off in France. *Eur J Health Econ* 2013;14:57-66.
- [30] Pol S, Chevalier J, Branchoux S, Perry R, Milligan G, Gaudin A-F. Health related quality of life and utility values in chronic hepatitis C patients: A cross-sectional study in France, the Uk and Germany (P0747). *J Hepatol* 2015;62:S606.
- [31] Chong CA, Gulamhussein A, Heathcote EJ, Lilly L, Sherman M, Naglie G, et al. Health-state utilities and quality of life in hepatitis C patients. *Am J Gastroenterol* 2003;98:630-638.
- [32] Prise en charge des personnes infectées par les virus de l'hépatite B ou de l'hépatite C. Rapport de recommandations 2014: Sous la direction du Pr Daniel Dhumeaux et sous l'égide de l'ANRS et de l'AFEF.
- [33] Bottero J, Brouard C, Roudot-Thoraval F, Deuffic-Burban S, Hofliger P, Abergel A, et al. 2014 French guidelines for hepatitis B and C screening: a combined targeted and mass testing strategy of chronic viruses namely HBV, HCV and HIV. *Liver Int* 2016;36:1442-1449.
- [34] Synthèse de la recommandation en santé publique - Réévaluation de la stratégie de dépistage de l'infection à VIH en France - Mars 2017. [cited April 3, 2018]; Available from: https://www.has-sante.fr/portail/upload/docs/application/pdf/2017-03/dir2/reevaluation_de_la_strategie_depistage_vih_-_synthese_reco.pdf
- [35] Moyer VA, U. S. Preventive Services Task Force. Screening for hepatitis C virus infection in adults: U.S. Preventive Services Task Force recommendation statement. *Ann Intern Med* 2013;159:349-357.
- [36] Rein DB, Smith BD, Wittenborn JS, Lesesne SB, Wagner LD, Roblin DW, et al. The cost-effectiveness of birth-cohort screening for hepatitis C antibody in U.S. primary care settings. *Ann Intern Med* 2012;156:263-270.

- [37] McGarry LJ, Pawar VS, Panchmatia HR, Rubin JL, Davis GL, Younossi ZM, et al. Economic model of a birth cohort screening program for hepatitis C virus. *Hepatology* 2012;55:1344-1355.
- [38] Coffin PO, Scott JD, Golden MR, Sullivan SD. Cost-effectiveness and population outcomes of general population screening for hepatitis C. *Clin Infect Dis* 2012;54:1259-1271.
- [39] Liu S, Cipriano LE, Holodniy M, Goldhaber-Fiebert JD. Cost-effectiveness analysis of risk-factor guided and birth-cohort screening for chronic hepatitis C infection in the United States. *PLoS One* 2013;8:e58975.
- [40] McEwan P, Ward T, Yuan Y, Kim R, L'Italien G. The impact of timing and prioritization on the cost-effectiveness of birth cohort testing and treatment for hepatitis C virus in the United States. *Hepatology* 2013;58:54-64.
- [41] Rein DB, Wittenborn JS, Dougherty MC. The Cost-effectiveness of a one time hepatitis C virus antibody test followed by treatment for all Americans ages 18 and older as compared to current testing recommendations in the United States. *J Hepatol* 2017;66 suppl:S405.
- [42] Barocas JA, Tasillo A, Eftekhari Yazdi G, Wang J, Vellozzi C, Hariri S, et al. Population level outcomes and cost-effectiveness of expanding the recommendation for age-based hepatitis C testing in the United States. *Clin Infect Dis* 2018.
- [43] Eckman MH, Talal AH, Gordon SC, Schiff E, Sherman KE. Cost-effectiveness of screening for chronic hepatitis C infection in the United States. *Clin Infect Dis* 2013;56:1382-1393.
- [44] Wong WW, Tu HA, Feld JJ, Wong T, Krahn M. Cost-effectiveness of screening for hepatitis C in Canada. *CMAJ* 2015;187:E110-121.
- [45] Canadian Task Force on Preventive Health C. Recommendations on hepatitis C screening for adults. *CMAJ* 2017;189:E594-E604.

[46] Dusheiko G. The impact of antiviral therapy for hepatitis C on the quality of life: a perspective. *Liver Int* 2017;37 Suppl 1:7-12.

[47] Cousien A, Tran VC, Deuffic-Burban S, Jauffret-Roustide M, Mabileau G, Dhersin JS, et al. Effectiveness and cost-effectiveness of interventions targeting harm reduction and chronic hepatitis C cascade of care in people who inject drugs; the case of France. *J Viral Hepat* 2018.

Table 1 – Characteristics of the study population [2, 3]

	Repartition by gender and age (%)	Proportion at high risk* (%)	Proportion of HCV-RNA positive (%)*	
			High risk†	Low risk†
Males				
18-39	20.78	39.80	0.173	0.188
40-59	17.29	68.50	0.131	0.165
60-80	10.64	73.30	0.212	0.921
Females				
18-39	20.75	52.10	0.030	0.003
40-59	17.50	79.30	0.219	0.073
60-80	13.05	83.20	0.775	0.299

*The corresponding distribution of HCV-RNA positive among the whole study population was: males, 16.25% (18-39), 10.52% (40-59), 18.34% (60-80); females, 1.52% (18-39), 14.11% (40-59), 39.26% (60-80). †High risk corresponded to the presence of risk factors as defined in supplementary Table S2; low risk to the absence.

Table 2 – Data on the proportion of screened individuals according to each strategy [2, 3]

Strategy	Males			Females		
	18-39	40-59	60-80	18-39	40-59	60-80
Low risk*						
S1 = risk-based	16%	16%	6%	18%	18%	4%
S2 = S1 + all men aged 18 to 59 years	50%	50%	6%	18%	18%	4%
S3 = S1 + all individuals aged 40 to 59 years	16%	50%	6%	18%	50%	4%
S4 = S1 + all individuals aged 40 to 80 years	16%	50%	50%	18%	50%	50%
S5 = S1 + all individuals aged 18 to 80 years	50%	50%	50%	50%	50%	50%
High risk*						
S1 = risk-based	19%	19%	10%	19%	19%	15%
S2 = S1 + all men aged 18 to 59 years	50%	50%	6%	18%	18%	4%
S3 = S1 + all individuals aged 40 to 59 years	16%	50%	6%	18%	50%	4%
S4 = S1 + all individuals aged 40 to 80 years	16%	50%	50%	18%	50%	50%
S5 = S1 + all individuals aged 18 to 80 years	50%	50%	50%	50%	50%	50%

*High risk corresponded to the presence of risk factors; low risk to the absence.

Table 3 – Base case cost-effectiveness analysis of different HCV screening strategies according to treatment initiation when fibrosis stage \geq F2 or regardless of fibrosis stage.

Strategy	QALY in the study population (a)	QALY in the HCV-RNA population	Average lifetime cost (€) (c)	ICER* (€/QALY) (c)/(a)
Treatment initiation when \geq F2				
S1 = Risk-based strategy	21.306358	16.738040	66.69	
S3 = S1 and all 40-59	21.306403	16.767182	68.78	Dominated [†]
S2 = S1 and all men 18-59	21.306404	16.768116	69.09	Dominated [†]
S4 = S1 and all 40-80	21.306520	16.791277	70.92	26,100
S5 = all 18-80	21.306538	16.807824	73.57	147,200
Treatment initiation regardless of fibrosis				
S1 = Risk-based strategy	21.308202	18.019951	77.26	
S3 = S1 and all 40-59	21.308268	18.061709	79.45	Dominated [†]
S2 = S1 and all men 18-59	21.308336	18.090401	80.16	Dominated [†]
S4 = S1 and all 40-80	21.308413	18.099513	81.78	21,400
S5 = all 18-80	21.308514	18.176948	84.92	31,100

*The comparator for each ICER is the previous least costly strategy; [†]weakly dominated strategy: higher ICER than that of a more effective alternative strategy.

Table 4 – Sensitivity analysis considering either alternative utility data set [31], or no utility benefit from achieving SVR: cost-effectiveness analysis with treatment initiation regardless of fibrosis stage.

Strategy	QALY in the study population (a)	QALY in the HCV-RNA population	Average lifetime cost (€) (c)	ICER* (€/QALY) (c)/(a)
Alternative utility data set				
S1 = Risk-based strategy	21.305749	16.415394	77.26	
S3 = S1 and all 40-59	21.305802	16.448852	79.45	Dominated [†]
S2 = S1 and all men 18-59	21.305832	16.465998	80.16	Dominated [†]
S4 = S1 and all 40-80	21.305927	16.473978	81.78	25,400
S5 = all 18-80	21.305980	16.520117	84.92	59,200
No utility benefit from SVR				
S1 = Risk-based strategy	21.304837	16.047927	77.26	
S3 = S1 and all 40-59	21.304874	16.071941	79.45	Dominated [†]
S2 = S1 and all men 18-59	21.304882	16.089423	80.16	Dominated [†]
S4 = S1 and all 40-80	21.304958	16.076145	81.78	37,400
S5 = all 18-80	21.304979	16.109002	84.92	149,500

*The comparator for each ICER is the previous least costly strategy; [†]Weakly dominated strategy: higher ICER than that of a more effective alternative strategy.

Table 5 – Sensitivity analysis considering a delay of one year after diagnosis before treatment initiation: cost-effectiveness analysis with treatment initiation regardless of fibrosis stage.

Strategy	QALY in the study population (a)	QALY in the HCV-RNA population	Average lifetime cost (€) (c)	ICER* (€/QALY) (c)/(a)
S1 = Risk-based strategy	21.308124	17.982605	76.32	
S3 = S1 and all 40-59	21.308144	17.995463	78.43	Dominated [†]
S2 = S1 and all men 18-59	21.308209	18.031147	79.11	32,800
S4 = S1 and all 40-80	21.308148	17.996044	80.26	Dominated [‡]
S5 = all 18-80	21.308224	18.058801	83.30	279,300

*The comparator for each ICER is the previous least costly strategy; [†]Weakly dominated strategy: higher ICER than that of a more effective alternative strategy; [‡]strongly dominated strategies: more expensive and less effective.

Figure legends

Fig. 1. Predicted one-year CHC prevalence among the 18-80 French general population according to the screening strategy: base case analysis.

Fig. 2. Predicted cumulative incidence of cirrhosis (F4), decompensated cirrhosis, hepatocellular carcinoma and liver deaths among CHC population after 10 (A) and 20 years (B): base case analysis.

Fig. 3. Cost-effectiveness analysis for the scenario considering treatment for all: (A) Efficiency frontier; (B) Percentage of acceptability for each strategy by WTP threshold.

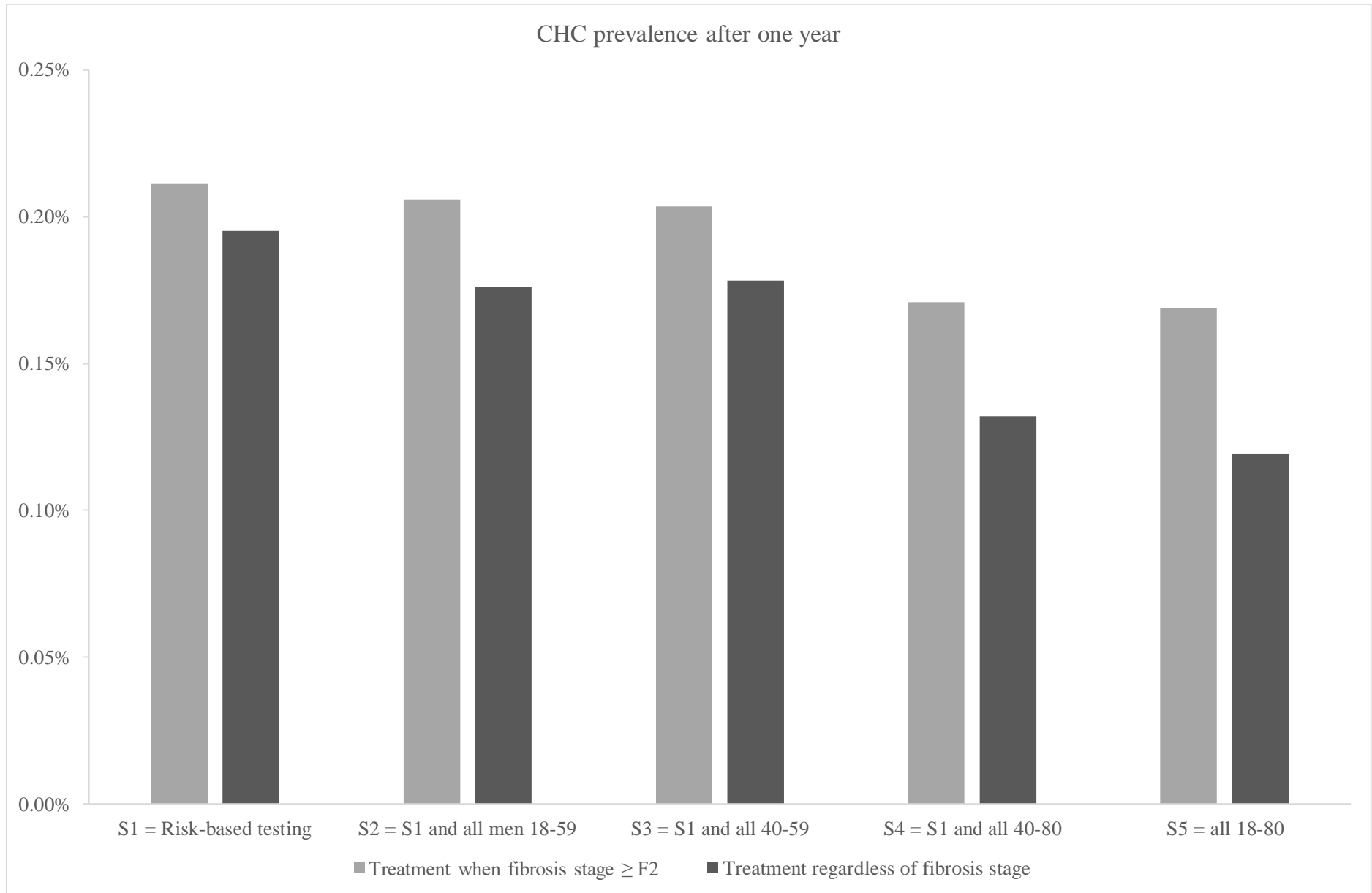

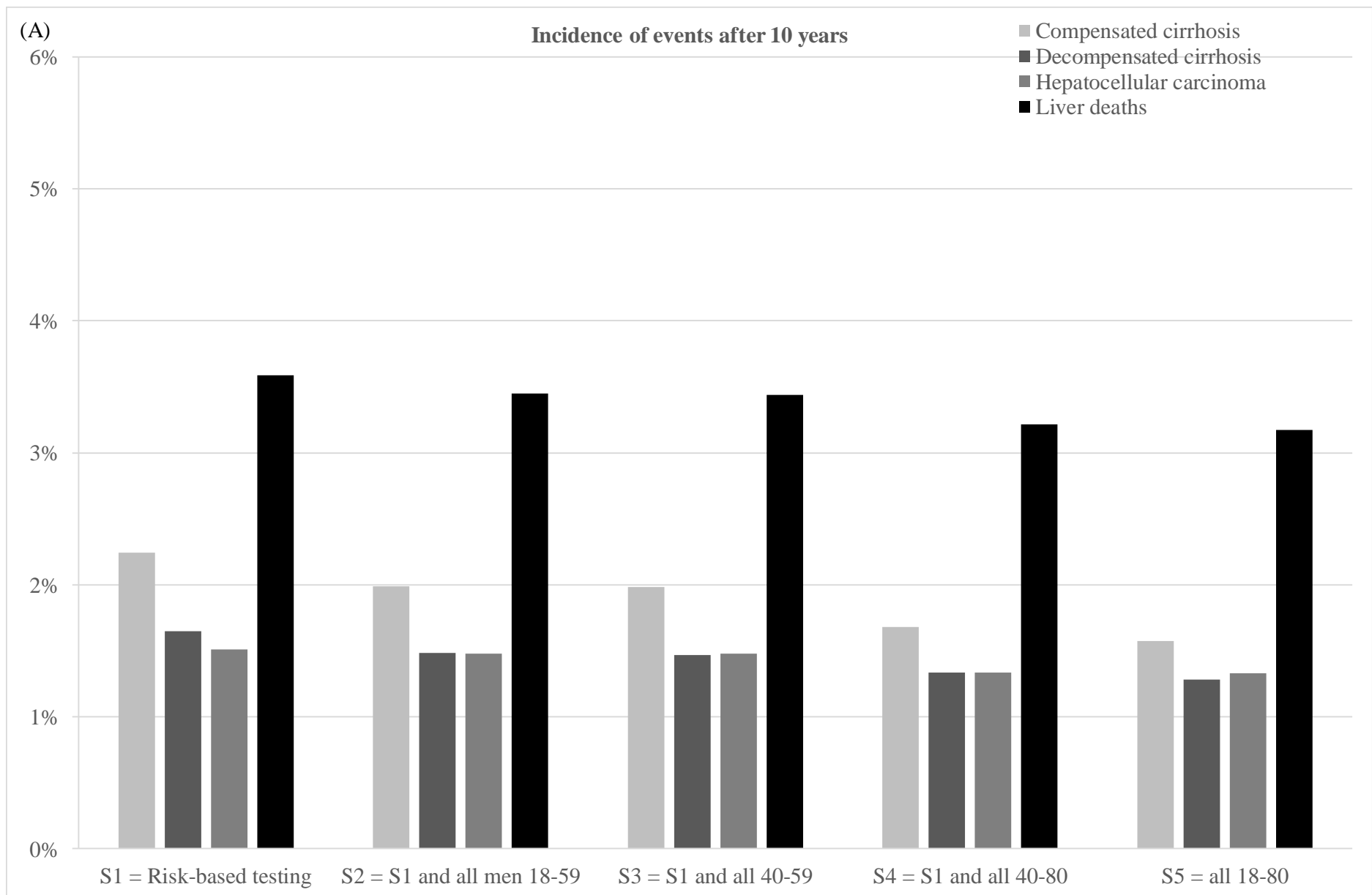

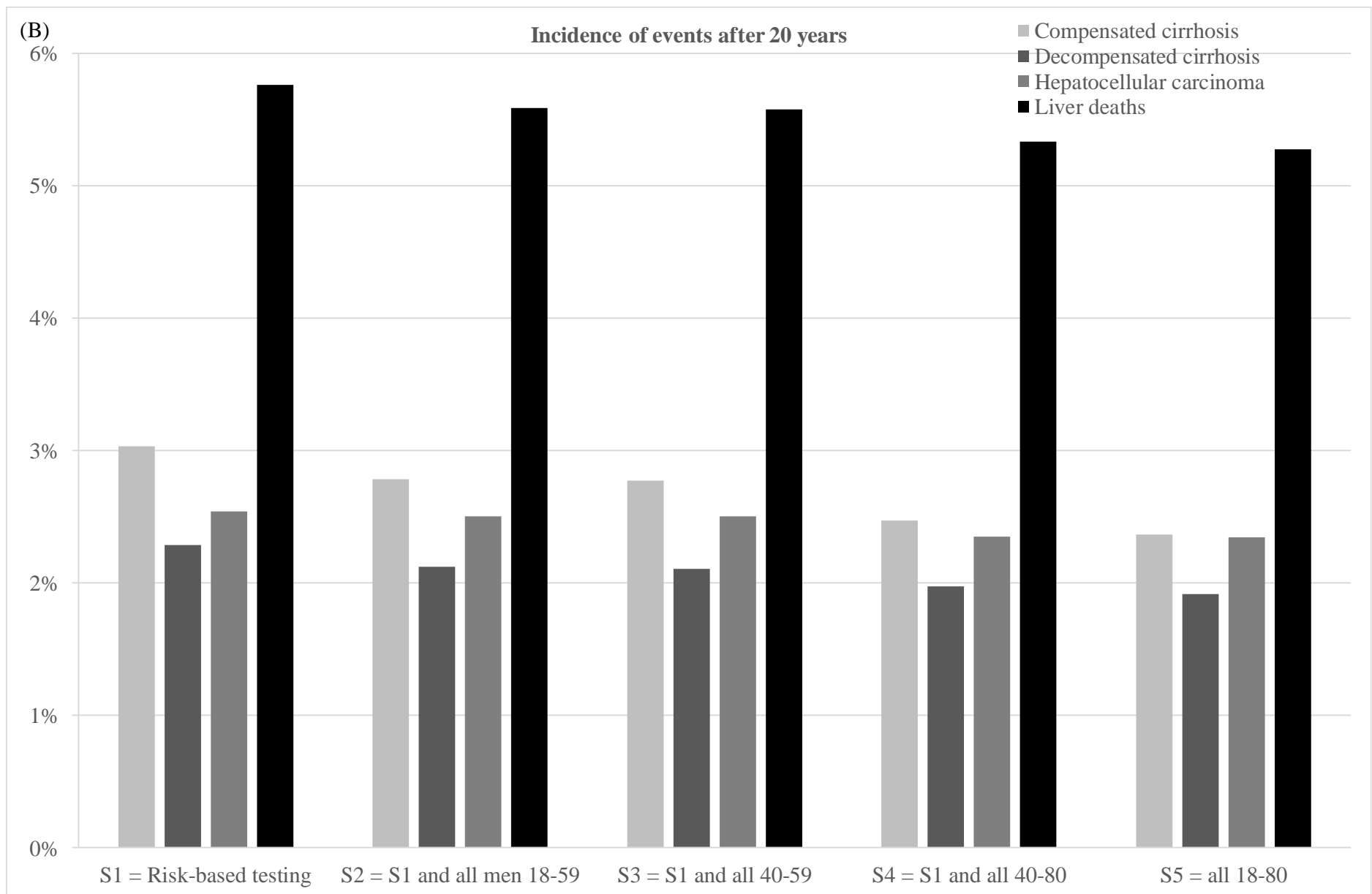

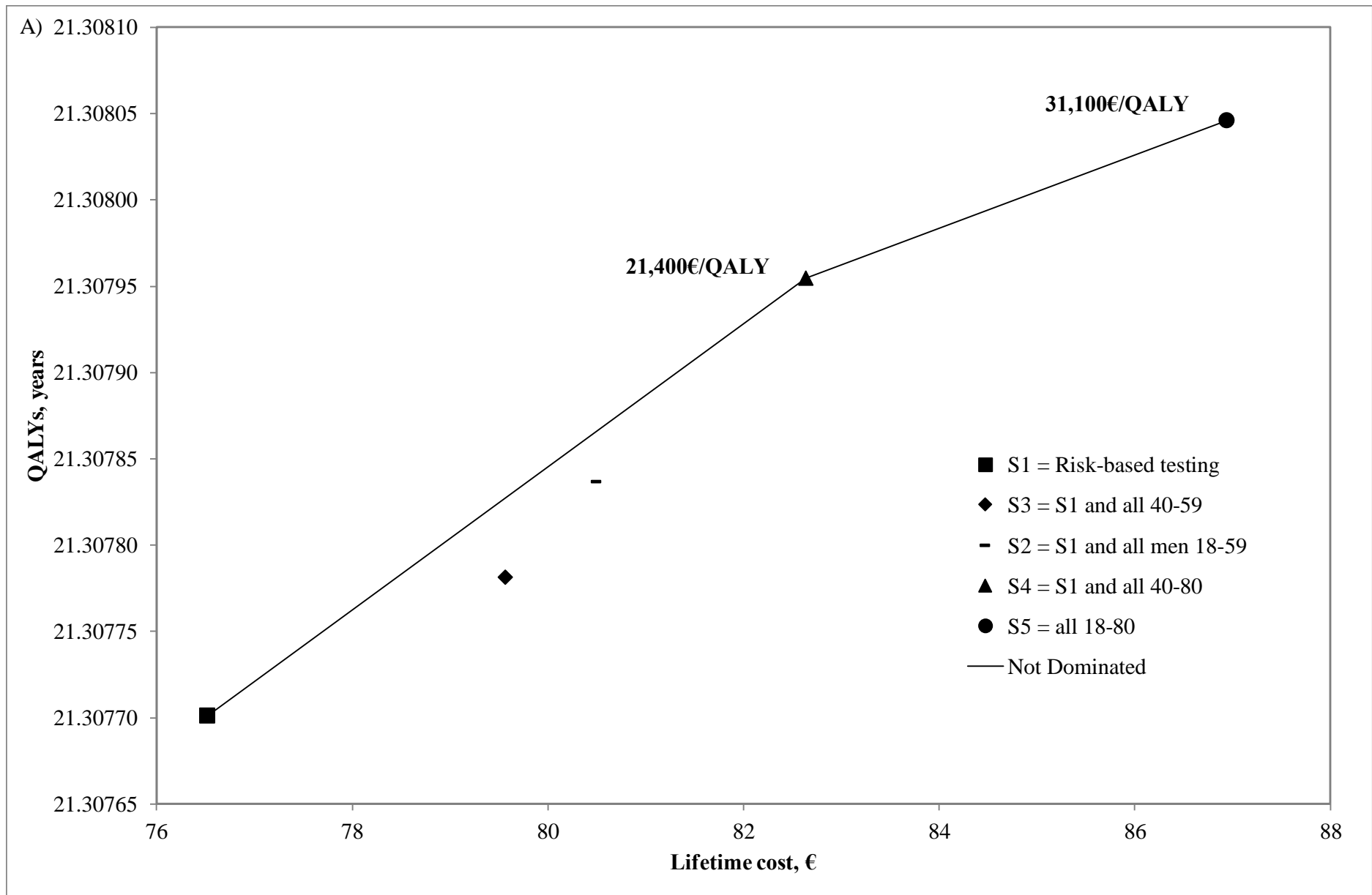

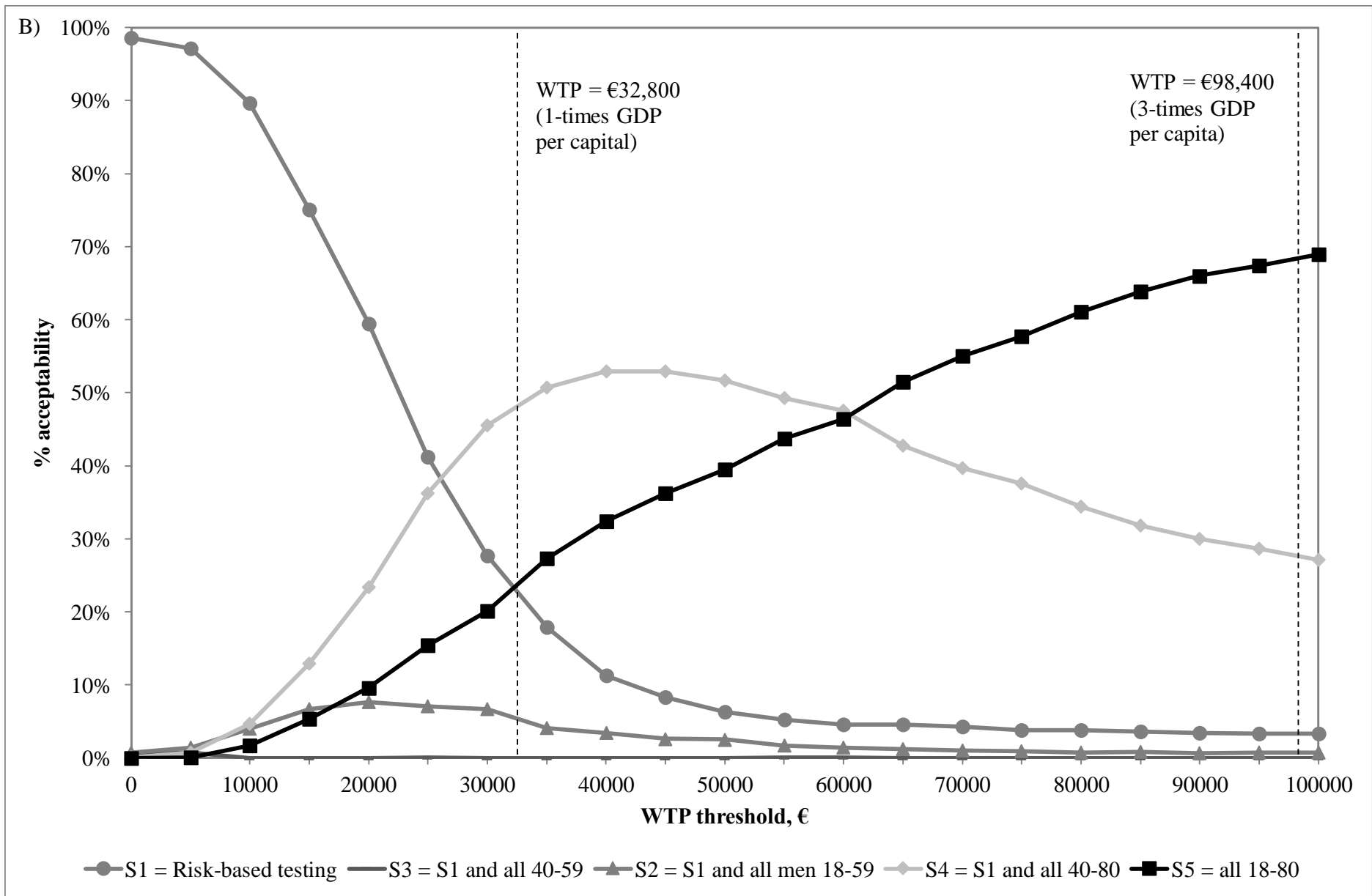

Supplementary Material accompanying the manuscript titled “Assessing the cost-effectiveness of hepatitis C screening strategies in France”

Sylvie Deuffic-Burban, Alexandre Huneau, Adeline Verleene, Cécile Brouard, Josiane Pillonel, Yann Le Strat, Sabrina Cossais, Françoise Roudot-Thoraval, Valérie Canva, Philippe Mathurin, Daniel Dhumeaux, Yazdan Yazdanpanah

Table of contents

Natural history of chronic hepatitis C	Erreur ! Signet non défini.
Study population	5
Cost data.....	7
Health-related quality of life	8
Sensitivity analysis	9
Figure S1. Model structure: a) Testing decision tree; b) Markov-based model of chronic hepatitis C progression. OH – corresponds to no alcohol abuse (0-50g/day), OH + corresponds to alcohol abuse (>50g/day).....	11
Figure S2. Predicted cumulative incidence of cirrhosis (F4), decompensated cirrhosis, hepatocellular carcinoma and liver deaths among CHC population after 10 years (A) and 20 years (B): base case analysis.	12
Supplementary Table 1 – Parameters of progression of chronic hepatitis C (CHC) and impact of treatment on progression.....	15
Supplementary Table 2 – French recommendations for HCV screening based on risk factors [12, 23]	17
Supplementary Table 3 – Disease stage distribution according to gender, age and alcohol status, and average time until diagnosis [7]	18
Supplementary Table 4 – Annual costs (standard deviation) attributable to chronic hepatitis C: ambulatory costs (never-treated and after HCV treatment failure) and hospitalization costs (no death and in-hospital death) [24].....	20
Supplementary Table 5 – Health-related utilities.....	21
Supplementary Table 6 – Distribution used for each model input during probabilistic sensitivity analysis.....	22

Supplementary Table 7 – Sensitivity analysis varying the proportions of high-risk population by $\pm 20\%$: cost-effectiveness analysis with treatment initiation regardless of fibrosis stage ..	23
Supplementary Table 8 – Sensitivity analysis varying the proportions of HCV-RNA positivity by $\pm 20\%$: cost-effectiveness analysis with treatment initiation regardless of fibrosis stage ..	24
Supplementary Table 9 – Sensitivity analysis varying the proportions of excessive alcohol consumption by $\pm 20\%$: cost-effectiveness analysis with treatment initiation regardless of fibrosis stage.....	25
Supplementary Table 10 – Sensitivity analysis varying the proportions of individuals reached by the current strategy by $\pm 20\%$: cost-effectiveness analysis with treatment initiation regardless of fibrosis stage	26
Supplementary Table 11 – Sensitivity analysis varying the proportions of individuals reached by an alternative strategy at 20% and 100%: cost-effectiveness analysis with treatment initiation regardless of fibrosis stage.....	27
Supplementary Table 12 – Sensitivity analysis decreasing the proportions of individuals initiating a treatment following screening to 50%: cost-effectiveness analysis with treatment initiation regardless of fibrosis stage.....	28
Supplementary Table 13 – Sensitivity analysis varying the probabilities of HCV progression by $\pm 20\%$: cost-effectiveness analysis with treatment initiation regardless of fibrosis stage ..	29
Supplementary Table 14 – Sensitivity analysis varying the cost related to health stages by $\pm 20\%$: cost-effectiveness analysis with treatment initiation regardless of fibrosis stage	30
Supplementary Table 15 – Sensitivity analysis varying the cost related to screening by $\pm 20\%$: cost-effectiveness analysis with treatment initiation regardless of fibrosis stage	31
Supplementary Table 16 – Sensitivity analysis varying the cost related to treatment initiation and follow-up (out of drugs cost) by $\pm 20\%$: cost-effectiveness analysis with treatment initiation regardless of fibrosis stage.....	32
Supplementary Table 17 – Sensitivity analysis varying drugs cost by $\pm 20\%$: cost-effectiveness analysis with treatment initiation regardless of fibrosis stage.....	33
Supplementary Table 18 – Sensitivity analysis varying the health-related utilities by $\pm 20\%$: cost-effectiveness analysis with treatment initiation regardless of fibrosis stage	34
Supplementary Table 19 – Sensitivity analysis varying the probabilities of SVR by $\pm 5\%$: cost-effectiveness analysis with treatment initiation regardless of fibrosis stage	35
Supplementary Table 20 – Sensitivity analysis using alternative distribution of the study population [13]: cost-effectiveness analysis with treatment initiation regardless of fibrosis stage.....	36

Supplementary Table 21 – Sensitivity analysis of results considering costs related to severe anemia leading to transfusion for patients initiating ribavirin [25]: cost-effectiveness analysis with treatment initiation regardless of fibrosis stage 37

Supplementary Table 22 – Bivariate sensitivity analysis of increasing screening uptake from 50% to 100% and cost of screening (Hepatitis C antibody test, HCV-RNA test) from 0% to 20%: average lifetime cost per person for the universal strategy and ICER for the universal screening strategy compared to the strategy targeting all individuals 40-80. 38

Supplementary References 39

Model structure

The testing decision tree was first divided according to the different screening strategies and according to the characteristics of individuals (Supplementary Fig. 1a). Then for each profile of individuals the Markov-based model simulated the progression through disease stages. At each cycle (one year) of the Markov model (Supplementary Fig. 1b), patients either remained at the same disease stage or progressed to a more severe stage. Probability of disease progression was based on international literature (Supplementary Table 1). Chronic hepatitis C was represented by different METAVIR fibrosis stages [1]. Fibrosis progression varied by sex, age and alcohol abuse [2]. Once patients had compensated cirrhosis (F4), they were at risk of developing liver decompensation according to alcohol abuse [3, 4] and hepatocellular carcinoma (HCC) related to age and sex [5]. Liver decompensation was divided into the following stages: (i) the first year of decompensation following ascites, gastrointestinal bleeding, encephalopathy or icterus; (ii) the period following initial decompensation, either stable or progressive decompensation based on the occurrence (or not) of successive decompensation episodes. Distribution into either progressive or stable decompensation was assumed to be 50% [6]. Patients in liver decompensation or HCC were considered for liver transplantation and probabilities were estimated from recent modeling studies [7, 8]. Finally, HCV-related mortality was defined as deaths occurring in patients with cirrhosis (F4), liver decompensation, HCC or after transplantation. Probability of HCV-related death from F4 or decompensated cirrhosis was extracted from a systematic review [9]. In F4 patients without complications, the probability of HCV-related death was estimated at 1% per year. In contrast, the probability of HCV-related death during the first year of decompensated cirrhosis was estimated at 39%. After the first year, patients had lower risk of HCV-related death: 12.5% per year for stable decompensation and 15.6% per year for progressive decompensation, extracted from cumulative survival rates in patients in Child-Pugh B and C

stages, respectively [9]. Probability of HCV-related death after HCC was considered to be time-dependent, with a higher death rate during the first year, 54%, compared to subsequent years, i.e. 27% [8]. Finally, transition probabilities from liver transplantation to HCV-related death was obtained via the French Agence de Biomédecine [10]. Background mortality probabilities, according to age and sex, were derived from French life tables [11].

Study population

The study population consisted of the French general population aged 18 to 80 years, without any known diagnosis of HCV-RNA positivity. Characteristics of this population were issued from the 2004 national seroprevalence survey of the French National Public Health agency [12, 13]. This cross-sectional survey among a random sample of residents of mainland France was conducted in 2004 to estimate the prevalence of hepatitis B and C virus infections.

Selected individuals received an invitation letter for a free medical checkup. An anti-HCV antibody screening test was first carried out for all participants. HCV RNA detection was then performed for those individuals diagnosed anti-HCV positive. Data were collected for demographic characteristics, potential exposure to HCV and any prior HCV screening and results. Awareness of HCV infection was assessed using these two last variables. This study used a complex sampling design to attempt to control as much as possible for selection bias. In particular, it included high-risk population for HCV: among the 14,416 adult participants enrolled, 0.64% were intravenous drug users, 2.6% were nasal drug users and 23.5 % were born abroad mainly from intermediate and high endemicity countries for HCV.

First, to assess and characterize the study population, individuals already aware of their HCV-RNA positivity were subtracted from the French general population aged 18 to 80 years according to gender and age. We then obtained determined characteristics of this population in high or low risk population according to the presence or absence of risk factors (Table 1

and Supplementary Table 2) [12, 13]. We finally obtained the estimated proportion of HCV-RNA positivity in this study population (Table 1) [12, 13].

Second, we fixed the proportion of individuals that will be reached by a given strategy according to gender, age and risk factors level. In the risk-based strategy, individuals were assumed to be tested as observed in the 2004 French survey, i.e. between 4% and 18% for individuals without risk factors and between 10% and 19% for those with risk factors (Table 2). For the new screening strategies, we assumed that 50% of targeted individuals were tested. For example, in the strategy targeting all men between 18 and 59 years, the proportion of tested men aged 18 to 59 was 50%, regardless of risk factors (Table 2).

Third, because excessive alcohol abuse was recognized as a risk factor of CHC progression [2, 4], we obtained the distribution of excessive alcohol abuse by gender and age using a previously published model [7], i.e. in males: 26% in 18-39, 18% in 40-59 and 3% in 60-80; in females: 6%, 4% and 2%, respectively.

Finally, the study population was stratified into fibrosis stage according to our previous modeling [7] (Supplementary Table 3). The estimated repartitions in fibrosis stage by gender, age and alcohol status of undiagnosed individuals were applied for individuals unreached by a given screening strategy at the beginning of the simulations, whereas those of diagnosed untreated individuals were applied for individuals that will be reached by the evaluated strategy [7]. For individuals unreached by a given strategy, we set a mean time until diagnosis according to gender, age and alcohol status. These mean times were calculated from the two distributions of fibrosis (diagnosed and undiagnosed individuals) by multiplying the difference of average fibrosis stage among diagnosed and undiagnosed individuals by the inverse of fibrosis transition rate, according to gender, age and alcohol status. Undiagnosed patients in decompensated cirrhosis were assumed to be diagnosed in the year of the 1st

decompensation whatever the strategy. These average times were included in the modeling for individuals unreached by a strategy. Globally, they corresponded to 1.95 years with the current risk-based strategy compared to 1.53 year when adding the screening of all men between 18 and 59 years, 1.82 when adding the screening of all individuals between 40 and 59 years, 1.73 years when adding the screening of all individuals between 40 and 80 years, and 1.18 years with universal screening.

Cost data

Cost inputs were limited to direct medical costs associated with HCV screening, HCV care and HCV treatment. Costs of HCV screening included the test for HCV antibodies, and when positive, a second HCV-antibodies test with HCV-RNA screening test to confirm chronic hepatitis C.

To estimate resource consumption for HCV care, we focused on ambulatory and acute hospital care of HCV mono-infected patients (Supplementary Table 4). To estimate resources used during ambulatory care, we conducted a retrospective survey of 128 consecutive patients who consulted their physician in 2011 (follow-up, 2.4 person-years) at a HCV care reference center (i.e. Assistance Publique, Hôpitaux de Paris, Cochin Hospital, Paris, France). To estimate resources used during inpatient stay, we also used the 2008-2010 French national database in which we identified 49,391 patients who were tracked over 3 years. Resources used were estimated for both ambulatory and acute hospital, but only concerning patients who were not on antiviral treatment and who were stratified by disease stage (F0-2, F3, F4, decompensated cirrhosis, HCC and liver transplant). To estimate costs, we assigned unit costs to each resource used and attributable to liver disease care. Regarding ambulatory costs, we relied on public tariffs of specialist visits, laboratory tests [14] and clinical procedures [15]. Regarding hospital costs, we used the French diagnosis-related group (DRG) classification

system [16]. The DRG system classifies diseases into medically and economically homogenous groups. DRG costs include physicians' and nurses' fees as well as mean cost of diagnosis, clinical procedures, laboratory tests, drugs dispensed during hospitalization and hotel/overhead costs.

We also estimated health care use for monitoring HCV treatments using French treatment guidelines (i.e. outpatient visits, laboratory tests, HCV-RNA tests, liver function tests).

Regarding costs related to adverse events, severe anemia necessitating transfusion for patients initiating ribavirin was only considered in sensitivity analysis (see below).

Health-related quality of life

A cross-sectional study was conducted in three French referral hepatology centers (Paris, Lille in northern France, and Montpellier in southern France) [17]. Patients included were aged 18-70, CHC mono-infected, treatment-naïves, relapsers (having received up to 2 treatments in the past), or non-responders, and were enrolled before treatment initiation. By January 2015, 505 patients were enrolled. Health utilities were estimated using EuroQol-5D and French Time-Trade-Off value set for patients in stage of fibrosis F0 to F4 (Supplementary Table 5) [18]. Number of patients in decompensated cirrhosis and HCC was too small to evaluate health utilities in complicated stages. Health utilities were therefore estimated from our estimate obtained for stage F4 and assuming the same decrease between patients in F4 and those in complicated stages observed in another study implemented in France, UK and Germany (Adelphi study) [19]. We assumed no loss in health utilities from being identified as HCV-positive or under treatment with IFN-free regimens.

Sensitivity analysis

Firstly, we performed a one-way deterministic sensitivity analysis, varying values of input parameters that may change our conclusions by $\pm 20\%$. In particular, we varied the proportions of high-risk population, HCV-RNA positivity, excessive alcohol consumption and individuals reached by the current screening strategy; the probabilities of HCV progression; the cost related to health stages, screening tests and treatment follow-up; drug cost; and the health-related utilities as well as post-SVR utility gains. Moreover, we varied the proportion of individuals that will be reached by a new strategy on the interval 20-100%, the proportion of the targeted population that will be treated on the interval 50-100%, and we varied the probability of SVR by $\pm 5\%$.

Regarding costs related to adverse events, severe anemia necessitating transfusion for patients initiating ribavirin was considered for a cost of 2,564€; this was estimated to happen for 0.3% of these patients (2.7% having severe anemia among which 10% would necessitate a transfusion) [20].

Secondly, a two-way deterministic sensitivity analysis for universal screening was conducted by increasing simultaneously uptake from 50% to 100% and cost of screening tests from 0% to 20%.

Finally, a probability sensitivity analysis was performed to account for uncertainty by simultaneously varying all input parameters from appropriate probability distributions (Supplementary Table 6). α and β parameters of Beta and Gamma distribution were derived from the average values $E(x)$ and standard errors σ – if known, 20% of the average otherwise – using the following equations:

$$\text{Beta:} \quad \alpha = \frac{E(x)^2 / (1 - E(x))}{\sigma^2} - E(x) \quad \beta = \frac{\alpha(1 - E(x))}{E(x)}$$

Gamma:

$$\alpha = \frac{E(x)^2}{\sigma^2}$$

$$\beta = \frac{E(x)}{\sigma^2}$$

Figure S1. Model structure: a) Testing decision tree; b) Markov-based model of chronic hepatitis C progression. OH – corresponds to no alcohol abuse (0-50g/day), OH + corresponds to alcohol abuse (>50g/day)

a)

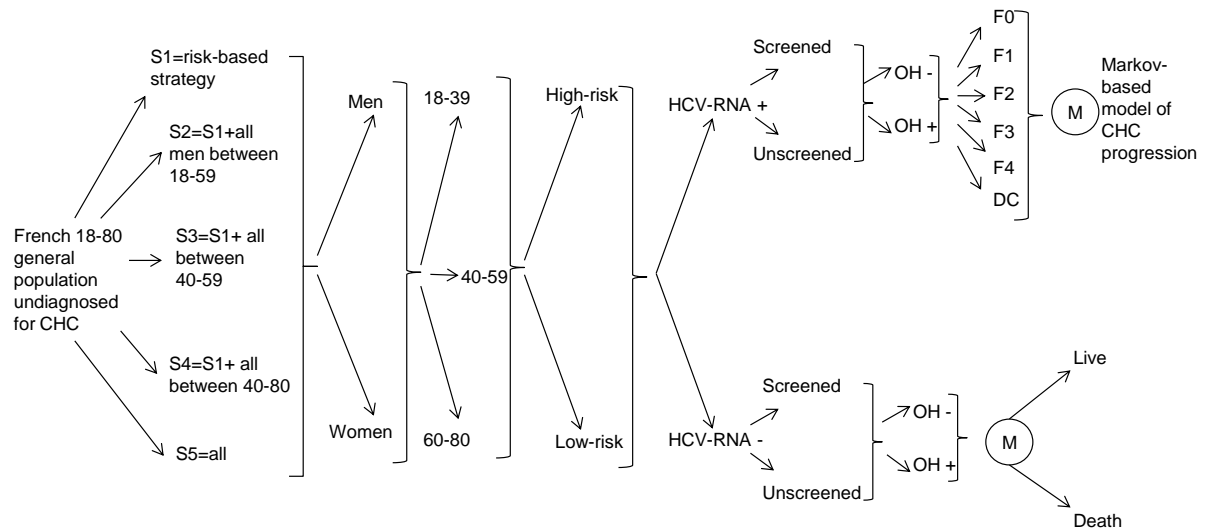

b)

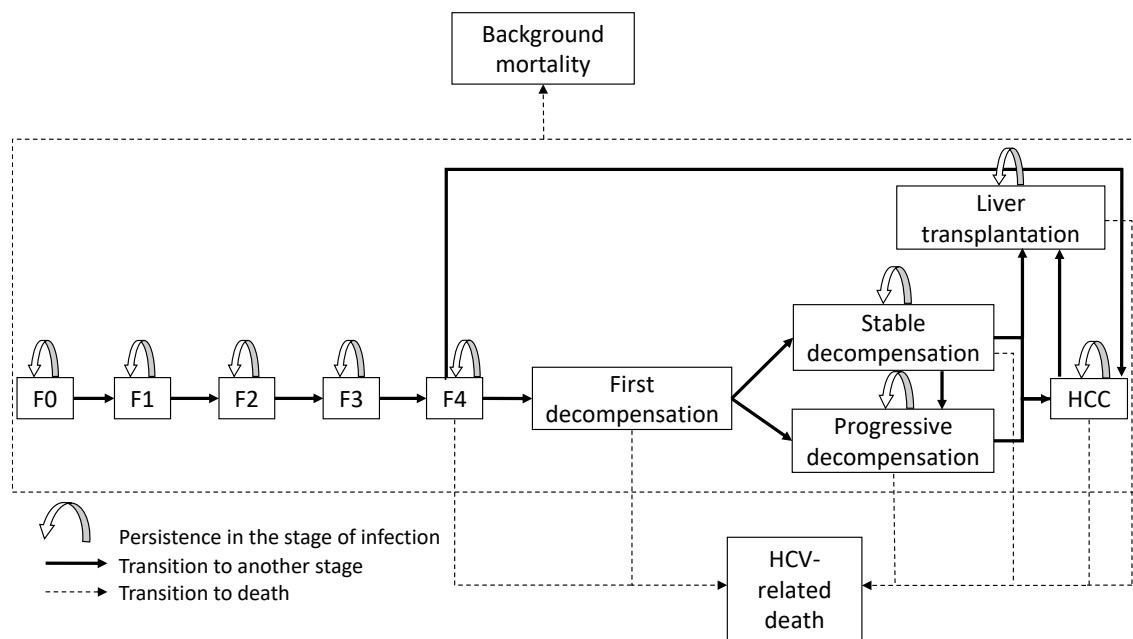
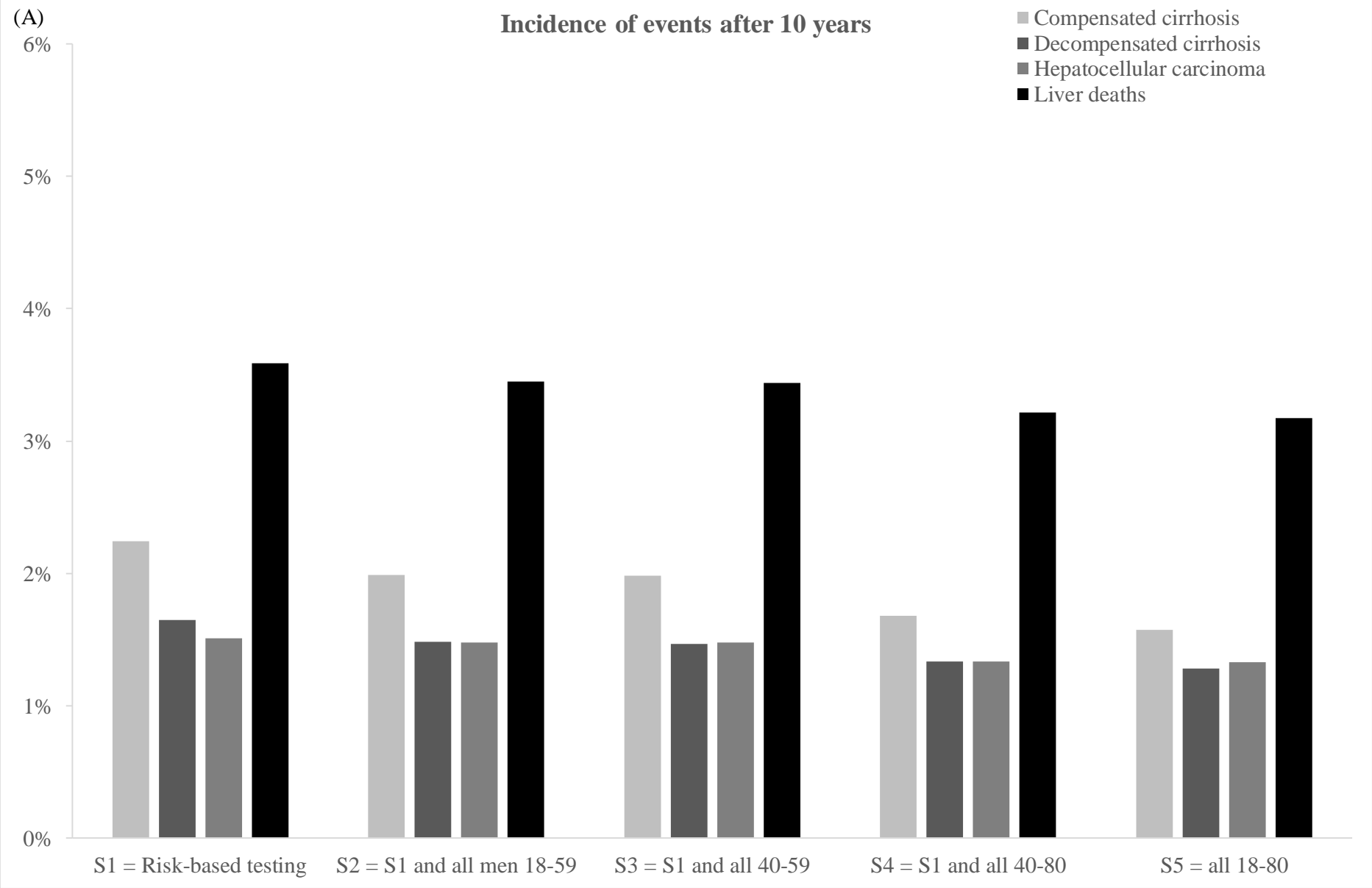

Figure S2. Predicted cumulative incidence of cirrhosis (F4), decompensated cirrhosis, hepatocellular carcinoma and liver deaths among CHC population after 10 years (A) and 20 years (B): base case analysis.



(B)

Incidence of events after 20 years

- Compensated cirrhosis
- Decompensated cirrhosis
- Hepatocellular carcinoma
- Liver deaths

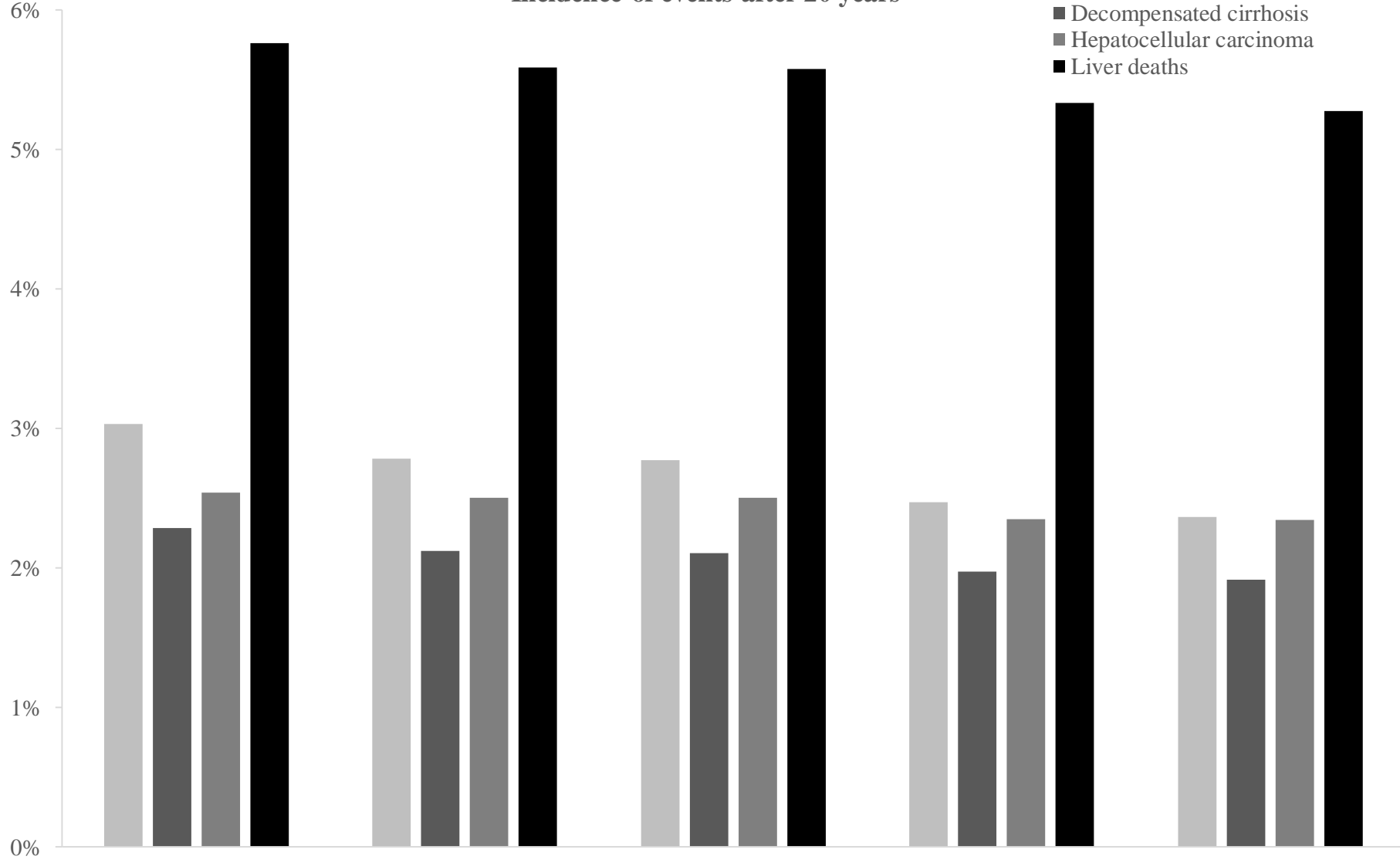

S1 = Risk-based testing

S2 = S1 and all men 18-59

S3 = S1 and all 40-59

S4 = S1 and all 40-80

S5 = all 18-80

Supplementary Table 1 – Parameters of progression of chronic hepatitis C (CHC) and impact of treatment on progression

Parameters	Value	References
Natural history of CHC	Probability (range)	
Fibrosis transition in women, alcohol-negative*		[2, 7]
0-40	0.049 (0.045-0.053)	
41-50	0.052 (0.046-0.058)	
51-60	0.055 (0.051-0.058)	
61-70	0.089 (0.087-0.091)	
>70	0.077 (0.076-0.078)	
Fibrosis transition in men, alcohol-negative*		[2, 7]
0-40	0.035 (0.034-0.036)	
41-50	0.094 (0.092-0.096)	
51-60	0.141 (0.139-0.143)	
61-70	0.244 (0.240-0.247)	
>70	0.193 (0.185-0.202)	
Transition from F4 (compensated cirrhosis) to:		
First decompensation (alcohol-negative)*	0.05	[3]
HCC (age- and sex-dependent)		[5]
Women, according to age x	$0.017 \times 1.05^{(x-57)}$	
Men, according to age x	$0.036 \times 1.05^{(x-57)}$	
HCV-related death	0.010 (0.010-0.034)	[9]
Transition from first decompensation to:		
Stable or progressive decompensation	0.50 (0.40-0.60)	[6]
HCV-related death	0.39 (0.20-0.55)	[9]
Transition from stable decompensation to:		
HCC	Same as F4	Assumption
LT (age \leq 70)	0.120	[7, 21]
HCV-related death	0.125	[9]
Transition from progressive decompensation to:		
HCC	Same as F4	Assumption
LT (age \leq 70)	0.120	[7, 21]
HCV-related death	0.156	[9]

Supplementary Table 1 – (continued)

Parameters	Value	References
Transition from HCC to:	Probability (range)	
LT (age≤70)	0.170	[7, 21]
HCV-related death (time-dependent)		[21]
First year after onset of HCC	0.54	
Following years after HCC onset	0.27	
Transition from LT to HCV-related death		[10]
First year after LT	0.160	
Following years after LT	0.032	
Patients achieving SVR at F4 stage [†]	RR (range)	[22]
HCV-related death	0.06 (0.02-0.19)	
Liver decompensation	0.07 (0.03-0.20)	
HCC development	0.19 (0.08-0.44)	

CHC, chronic hepatitis C; HCC, hepatocellular carcinoma; LT, liver transplantation.

*Fibrosis transition rates in alcohol-positive patients were 3 times higher at F0, F1, F2 and F3, and 4.5 times higher at F4 [4]; [†]Relative risk of liver progression or death in patients who achieved SVR at F4 stage versus treatment failure or no treatment.

Supplementary Table 2 – French recommendations for HCV screening based on risk factors [12, 23]

Persons who have received blood products or tissue transplant, cells or organs, before 1992;

Persons who injected drugs at least once in their lives;

Persons having undergone endoscopic examinations with biopsy;

Persons having had invasive radiological exams;

Persons being hemophilic;

Persons undergoing haemodialysis;

Prisoners and previously incarcerated persons;

Persons from or who received care in countries with a high HCV endemicity (Southeast Asia,

Middle East, Africa, South America)

Persons who have had tattoos, body piercing, sclerosis varices, acupuncture or mesotherapy

procedures

Supplementary Table 3 – Disease stage distribution according to gender, age and alcohol status, and average time until diagnosis [7]

	Males						Females					
	Alcohol (0-50g/day)			Alcohol (>50g/day)			Alcohol (0-50g/day)			Alcohol (>50g/day)		
	18-39	40-59	60-80	18-39	40-59	60-80	18-39	40-59	60-80	18-39	40-59	60-80
Disease stage distribution for undiagnosed individuals, %												
Fibrosis F0	66.0	21.9	2.4	41.5	6.3	2.5	58.7	27.7	13.2	32.9	9.5	3.0
Fibrosis F1	24.7	29.9	7.8	30.7	13.6	3.3	27.9	33.3	25.9	29.0	16.3	8.7
Fibrosis F2	6.9	24.4	15.3	17.6	20.6	5.4	9.9	23.3	27.5	20.7	24.8	18.8
Fibrosis F3	1.5	14.8	21.6	6.8	17.7	6.6	2.8	11.3	20.5	10.0	20.7	19.8
Fibrosis F4	0.8	8.6	50.4	2.9	34.5	65.2	0.7	4.1	12.4	6.3	23.6	40.6
Decompensated cirrhosis, 1 st year	0.0	0.4	2.6	0.5	7.3	17.0	0.0	0.2	0.6	1.2	5.1	9.2
Decompensated cirrhosis, >1 years	0.0	0.0	0.0	0.0	0.0	0.0	0.0	0.0	0.0	0.0	0.0	0.0
Disease stage distribution for diagnosed individuals, %												
Fibrosis F0	55.7	22.7	1.8	32.0	2.7	0.0	48.5	28.4	14.0	21.0	3.1	0.6
Fibrosis F1	31.2	33.4	7.0	32.7	7.2	0.1	34.7	38.8	29.9	26.5	8.9	2.8
Fibrosis F2	8.0	22.4	11.7	18.6	9.8	0.2	11.8	19.9	25.5	18.8	12.1	5.7

Fibrosis F3	1.6	11.6	14.8	7.2	7.9	0.3	3.2	7.9	16.2	9.9	9.2	5.7
Fibrosis F4	0.6	6.0	33.3	3.0	14.5	3.1	0.8	2.7	8.8	6.4	10.9	10.7
Decompensated cirrhosis, 1 st year	0.0	0.3	1.7	0.6	3.1	0.8	0.0	0.1	0.4	1.2	2.4	2.4
Decompensated cirrhosis, >1 years	2.8	3.7	29.6	5.9	54.8	95.5	0.9	2.1	5.2	15.2	53.5	72.2
<hr/>												
Average time until diagnosis, years*												
Patients in F0-2	6	1	1	3	2	1	3	1	1	4	6	3
Patients in F3-4	6	1	1	2	2	1	3	1	1	3	4	2

*Undiagnosed patients in decompensated cirrhosis were assumed to be diagnosed in the year of the 1st decompensation

Supplementary Table 4 – Annual costs (standard deviation) attributable to chronic hepatitis C: ambulatory costs (never-treated and after HCV treatment failure) and hospitalization costs (no death and in-hospital death) [24]

Liver disease stage	Ambulatory costs, mean (SD) €		Hospitalization costs, mean (SD) €	
	Never-treated	After treatment failure	No death	In-hospital death
Fibrosis F0 to F2	70 (10)	53 (12)	278 (1,087)	337 (1,377)
Fibrosis F3	128 (22)	86 (15)		
Cirrhosis, compensated (F4)	228 (20)	71 (18)	1,295 (3,732)	6,450 (11,422)
Cirrhosis, decompensated				
First year or stable	96 (21)	96 (21)	8,122 (9,177)	11,059 (11,226)
Progressive	96 (21)	96 (21)	15,032 (17,552)	19,935 (20,639)
HCC	96 (21)	96 (21)	11,745 (11,634)	16,643 (14,137)
Liver transplant				
First year	0	0	56,021 (40,329)	90,712 (55,462)
Following years	0	0	5,445 (11,123)	15,911 (23,307)

Supplementary Table 5 – Health-related utilities

	Value	References
<hr/>		
Health-related utilities in CHC patients		
Fibrosis F0 to F2	0.82	[17]
Fibrosis F3 to F4	0.76	[17]
Decompensated cirrhosis / Hepatocellular carcinoma	0.60	[17, 19]
Liver transplant – 1 st year	0.55	[17, 19]
Liver transplant – subsequent year	0.82	[17, 19]
Health-related utilities in patients after sustained virological response		[19]
Sustained virological response from F0-F1	0.95	
Sustained virological response from F2-F3-F4	0.85	
<hr/>		

Supplementary Table 6 – Distribution used for each model input during probabilistic sensitivity analysis

Input	Distribution
Proportions of high-risk population by gender and age	Beta
Proportions of HCV-RNA positivity by gender, age and risk factor	Beta
Proportions of excessive alcohol consumption by gender and age	Beta
Probabilities of HCV progression by stage and cofactor	Normal
Proportions of individuals reached by the current screening strategy by risk factor	Beta
Proportions of individuals reached by an alternative screening strategy	Uniform
Proportions of treatment initiation	Uniform
Proportions of SVR in stage F0-4 and in decompensated cirrhosis	Beta
Ambulatory costs related to health stages	Gamma
Hospitalization costs related to health stages F0-3	Triangular
Hospitalization costs related to health stages \geq F4	Log-normal
Costs related to screening	Triangular
Costs related to treatment (out of drug cost)	Triangular
Health-related utilities	Beta
Post-SVR utility gains	Uniform

Supplementary Table 7 – Sensitivity analysis varying the proportions of high-risk population by $\pm 20\%$: cost-effectiveness analysis with treatment initiation regardless of fibrosis stage

Strategy	QALY in the study population (a)	QALY in the HCV-RNA population	Average lifetime cost (€) (c)	ICER* (€/QALY) (c)/(a)
-20%-variation				
S1 = Risk-based strategy	21.308161	18.018267	76.89	
S3 = S1 and all 40-59	21.308225	18.060451	79.10	Dominated [†]
S2 = S1 and all men 18-59	21.308298	18.098562	79.83	Dominated [†]
S4 = S1 and all 40-80	21.308386	18.089908	81.51	20,500
S5 = all 18-80	21.308487	18.176948	84.67	31,300
+20%-variation				
S1 = Risk-based strategy	21.308244	18.021634	77.62	
S3 = S1 and all 40-59	21.308311	18.062966	79.80	Dominated [†]
S2 = S1 and all men 18-59	21.308374	18.100463	80.49	22,100
S4 = S1 and all 40-80	21.308441	18.090894	82.04	23,100
S5 = all 18-80	21.308541	18.176948	85.17	31,300

*The comparator for each ICER is the previous least costly strategy; [†]Weakly dominated strategy:

higher ICER than that of a more effective alternative strategy.

Supplementary Table 8 – Sensitivity analysis varying the proportions of HCV-RNA positivity by $\pm 20\%$: cost-effectiveness analysis with treatment initiation regardless of fibrosis stage

Strategy	QALY in the study population (a)	QALY in the HCV-RNA population	Average lifetime cost (€) (c)	ICER* (€/QALY) (c)/(a)
-20%-variation				
S1 = Risk-based strategy	21.309637	18.019951	62.45	
S3 = S1 and all 40-59	21.309690	18.061709	64.63	Dominated [†]
S2 = S1 and all men 18-59	21.309745	18.099513	65.26	26,000
S4 = S1 and all 40-80	21.309806	18.090401	66.86	26,200
S5 = all 18-80	21.309887	18.176948	69.89	37,400
+20%-variation				
S1 = Risk-based strategy	21.306767	18.019951	92.06	
S3 = S1 and all 40-59	21.306846	18.061709	94.26	Dominated [†]
S2 = S1 and all men 18-59	21.306928	18.099513	95.06	18,700
S4 = S1 and all 40-80	21.307020	18.090401	96.70	18,900
S5 = all 18-80	21.307141	18.176948	99.95	27,200

*The comparator for each ICER is the previous least costly strategy; [†]Weakly dominated strategy:

higher ICER than that of a more effective alternative strategy.

Supplementary Table 9 – Sensitivity analysis varying the proportions of excessive alcohol consumption by $\pm 20\%$: cost-effectiveness analysis with treatment initiation regardless of fibrosis stage

Strategy	QALY in the study population (a)	QALY in the HCV-RNA population	Average lifetime cost (€) (c)	ICER* (€/QALY) (c)/(a)
-20%-variation				
S1 = Risk-based strategy	21.308285	18.071439	76.91	
S3 = S1 and all 40-59	21.308345	18.109111	79.12	Dominated [†]
S2 = S1 and all men 18-59	21.308415	18.148042	79.84	Dominated [†]
S4 = S1 and all 40-80	21.308488	18.137472	81.45	22,400
S5 = all 18-80	21.308589	18.223183	84.62	31,400
+20%-variation				
S1 = Risk-based strategy	21.308119	17.968463	77.61	
S3 = S1 and all 40-59	21.308191	18.014306	79.78	Dominated [†]
S2 = S1 and all men 18-59	21.308257	18.050983	80.47	Dominated [†]
S4 = S1 and all 40-80	21.308338	18.043330	82.10	20,500
S5 = all 18-80	21.308439	18.130712	85.23	31,000

*The comparator for each ICER is the previous least costly strategy; [†]Weakly dominated strategy: higher ICER than that of a more effective alternative strategy.

Supplementary Table 10 – Sensitivity analysis varying the proportions of individuals reached by the current strategy by $\pm 20\%$: cost-effectiveness analysis with treatment initiation regardless of fibrosis stage

Strategy	QALY in the study population (a)	QALY in the HCV-RNA population	Average lifetime cost (€) (c)	ICER* (€/QALY) (c)/(a)
-20%-variation				
S1 = Risk-based strategy	21.308176	18.004083	76.52	
S3 = S1 and all 40-59	21.308249	18.050666	78.96	Dominated [†]
S2 = S1 and all men 18-59	21.308324	18.092210	79.73	Dominated [†]
S4 = S1 and all 40-80	21.308403	18.080886	81.43	21,600
S5 = all 18-80	21.308514	18.176948	84.92	31,400
+20%-variation				
S1 = Risk-based strategy	21.308228	18.035819	78.00	
S3 = S1 and all 40-59	21.308287	18.072751	79.93	Dominated [†]
S2 = S1 and all men 18-59	21.308348	18.106815	80.59	Dominated [†]
S4 = S1 and all 40-80	21.308424	18.099916	82.12	21,000
S5 = all 18-80	21.308514	18.176948	84.92	31,100

*The comparator for each ICER is the previous least costly strategy; [†]Weakly dominated strategy: higher ICER than that of a more effective alternative strategy.

Supplementary Table 11 – Sensitivity analysis varying the proportions of individuals reached by an alternative strategy at 20% and 100%: cost-effectiveness analysis with treatment initiation regardless of fibrosis stage

Strategy	QALY in the study population (a)	QALY in the HCV-RNA population	Average lifetime cost (€) (c)	ICER* (€/QALY) (c)/(a)
20%-uptake				
S1 = Risk-based strategy	21.308202	18.019951	77.26	
S3 = S1 and all 40-59	21.308206	18.022176	77.37	Dominated [†]
S2 = S1 and all men 18-59	21.308213	18.026079	77.48	Dominated [†]
S4 = S1 and all 40-80	21.308239	18.029071	77.88	16,800
S5 = all 18-80	21.308248	18.035145	78.10	24,400
100%-uptake				
S1 = Risk-based strategy	21.308202	18.019951	77.26	
S3 = S1 and all 40-59	21.308372	18.127596	82.92	Dominated [†]
S2 = S1 and all men 18-59	21.308542	18.221902	84.62	21,600
S4 = S1 and all 40-80	21.308703	18.192617	88.26	22,600
S5 = all 18-80	21.308958	18.413285	96.29	31,500

*The comparator for each ICER is the previous least costly strategy; [†]Weakly dominated strategy: higher ICER than that of a more effective alternative strategy.

Supplementary Table 12 – Sensitivity analysis decreasing the proportions of individuals initiating a treatment following screening to 50%: cost-effectiveness analysis with treatment initiation regardless of fibrosis stage

Strategy	QALY in the study population (a)	QALY in the HCV-RNA population	Average lifetime cost (€) (c)	ICER* (€/QALY) (c)/(a)
S1 = Risk-based strategy	21.307708	17.806934	74.67	
S3 = S1 and all 40-59	21.307772	17.847581	76.88	Dominated [†]
S2 = S1 and all men 18-59	21.307840	17.885055	77.56	21,900
S4 = S1 and all 40-80	21.307901	17.872947	79.25	27,700
S5 = all 18-80	21.308000	17.958111	82.38	31,600

*The comparator for each ICER is the previous least costly strategy; [†]Weakly dominated strategy: higher ICER than that of a more effective alternative strategy.

Supplementary Table 13 – Sensitivity analysis varying the probabilities of HCV progression by $\pm 20\%$: cost-effectiveness analysis with treatment initiation regardless of fibrosis stage

Strategy	QALY in the study population (a)	QALY in the HCV-RNA population	Average lifetime cost (€) (c)	ICER* (€/QALY) (c)/(a)
-20%-variation				
S1 = Risk-based strategy	21.308534	18.162613	77.88	
S3 = S1 and all 40-59	21.308588	18.196883	80.07	Dominated [†]
S2 = S1 and all men 18-59	21.308653	18.232811	80.78	24,400
S4 = S1 and all 40-80	21.308708	18.220390	82.34	28,400
S5 = all 18-80	21.308801	18.299627	85.49	33,900
+20%-variation				
S1 = Risk-based strategy	21.307882	17.880908	76.47	
S3 = S1 and all 40-59	21.307960	17.932462	78.67	Dominated [†]
S2 = S1 and all men 18-59	21.308032	17.970316	79.38	Dominated [†]
S4 = S1 and all 40-80	21.308131	17.964436	81.08	18,500
S5 = all 18-80	21.308240	18.058764	84.23	28,900

*The comparator for each ICER is the previous least costly strategy; [†]Weakly dominated strategy:

higher ICER than that of a more effective alternative strategy.

Supplementary Table 14 – Sensitivity analysis varying the cost related to health stages by ± 20%: cost-effectiveness analysis with treatment initiation regardless of fibrosis stage

Strategy	QALY in the study population (a)	QALY in the HCV-RNA population	Average lifetime cost (€) (c)	ICER* (€/QALY) (c)/(a)
-20%-variation				
S1 = Risk-based strategy	21.308202	18.019951	75.01	
S3 = S1 and all 40-59	21.308268	18.061709	77.25	Dominated†
S2 = S1 and all men 18-59	21.308336	18.099513	77.98	Dominated†
S4 = S1 and all 40-80	21.308413	18.090401	79.68	22,100
S5 = all 18-80	21.308514	18.176948	82.86	31,500
+20%-variation				
S1 = Risk-based strategy	21.308202	18.019951	79.51	
S3 = S1 and all 40-59	21.308268	18.061709	81.65	Dominated†
S2 = S1 and all men 18-59	21.308336	18.099513	82.34	Dominated†
S4 = S1 and all 40-80	21.308413	18.090401	83.87	20,700
S5 = all 18-80	21.308514	18.176948	86.98	30,800

*The comparator for each ICER is the previous least costly strategy; †Weakly dominated strategy:

higher ICER than that of a more effective alternative strategy.

Supplementary Table 15 – Sensitivity analysis varying the cost related to screening by $\pm 20\%$ (Hepatitis C antibody test, HCV-RNA test): cost-effectiveness analysis with treatment initiation regardless of fibrosis stage

Strategy	QALY in the study population (a)	QALY in the HCV-RNA population	Average lifetime cost (€) (c)	ICER* (€/QALY) (c)/(a)
-20%-variation				
S1 = Risk-based strategy	21.308202	18.019951	76.61	
S3 = S1 and all 40-59	21.308268	18.061709	78.36	Dominated [†]
S2 = S1 and all men 18-59	21.308336	18.099513	79.02	Dominated [†]
S4 = S1 and all 40-80	21.308413	18.090401	80.33	17,600
S5 = all 18-80	21.308514	18.176948	82.95	25,900
+20%-variation				
S1 = Risk-based strategy	21.308202	18.019951	77.91	
S3 = S1 and all 40-59	21.308268	18.061709	80.53	Dominated [†]
S2 = S1 and all men 18-59	21.308336	18.099513	81.30	Dominated [†]
S4 = S1 and all 40-80	21.308413	18.090401	83.23	25,200
S5 = all 18-80	21.308514	18.176948	86.90	36,300

*The comparator for each ICER is the previous least costly strategy; [†]Weakly dominated strategy:

higher ICER than that of a more effective alternative strategy.

Supplementary Table 16 – Sensitivity analysis varying the cost related to treatment initiation and follow-up (out of drugs cost) by $\pm 20\%$: cost-effectiveness analysis with treatment initiation regardless of fibrosis stage

Strategy	QALY in the study population (a)	QALY in the HCV-RNA population	Average lifetime cost (€) (c)	ICER* (€/QALY) (c)/(a)
-20%-variation				
S1 = Risk-based strategy	21.308202	18.019951	77.05	
S3 = S1 and all 40-59	21.308268	18.061709	79.24	Dominated [†]
S2 = S1 and all men 18-59	21.308336	18.099513	79.95	Dominated [†]
S4 = S1 and all 40-80	21.308413	18.090401	81.56	21,400
S5 = all 18-80	21.308514	18.176948	84.71	31,200
+20%-variation				
S1 = Risk-based strategy	21.308202	18.019951	77.46	
S3 = S1 and all 40-59	21.308268	18.061709	79.66	Dominated [†]
S2 = S1 and all men 18-59	21.308336	18.099513	80.37	Dominated [†]
S4 = S1 and all 40-80	21.308413	18.090401	81.99	21,500
S5 = all 18-80	21.308514	18.176948	85.14	31,200

*The comparator for each ICER is the previous least costly strategy; [†]Weakly dominated strategy:

higher ICER than that of a more effective alternative strategy.

Supplementary Table 17 – Sensitivity analysis varying drugs cost by $\pm 20\%$: cost-effectiveness analysis with treatment initiation regardless of fibrosis stage

Strategy	QALY in the study population (a)	QALY in the HCV-RNA population	Average lifetime cost (€) (c)	ICER* (€/QALY) (c)/(a)
-20%-variation				
S1 = Risk-based strategy	21.308202	18.019951	64.91	
S3 = S1 and all 40-59	21.308268	18.061709	67.05	Dominated [†]
S2 = S1 and all men 18-59	21.308336	18.099513	67.66	Dominated [†]
S4 = S1 and all 40-80	21.308413	18.090401	69.18	20,200
S5 = all 18-80	21.308514	18.176948	72.18	29,700
+20%-variation				
S1 = Risk-based strategy	21.308202	18.019951	89.60	
S3 = S1 and all 40-59	21.308268	18.061709	91.84	Dominated [†]
S2 = S1 and all men 18-59	21.308336	18.099513	92.66	Dominated [†]
S4 = S1 and all 40-80	21.308413	18.090401	94.37	22,600
S5 = all 18-80	21.308514	18.176948	97.66	32,600

*The comparator for each ICER is the previous least costly strategy; [†]Weakly dominated strategy:

higher ICER than that of a more effective alternative strategy.

Supplementary Table 18 – Sensitivity analysis varying the health-related utilities by $\pm 20\%$:
cost-effectiveness analysis with treatment initiation regardless of fibrosis stage

Strategy	QALY in the study population (a)	QALY in the HCV-RNA population	Average lifetime cost (€) (c)	ICER* (€/QALY) (c)/(a)
-20%-variation				
S1 = Risk-based strategy	21.302473	14.810366	77.26	
S3 = S1 and all 40-59	21.302531	14.847320	79.45	Dominated [†]
S2 = S1 and all men 18-59	21.302598	14.884284	80.16	23,200
S4 = S1 and all 40-80	21.302660	14.872516	81.78	26,100
S5 = all 18-80	21.302756	14.955148	84.92	32,700
+20%-variation				
S1 = Risk-based strategy	21.313931	21.229536	77.26	
S3 = S1 and all 40-59	21.314005	21.276097	79.45	Dominated [†]
S2 = S1 and all men 18-59	21.314074	21.314742	80.16	Dominated [†]
S4 = S1 and all 40-80	21.314167	21.308285	81.78	19,200
S5 = all 18-80	21.314272	21.398748	84.92	29,900

*The comparator for each ICER is the previous least costly strategy; [†]Weakly dominated strategy:

higher ICER than that of a more effective alternative strategy.

Supplementary Table 19 – Sensitivity analysis varying the probabilities of SVR by $\pm 5\%$:
cost-effectiveness analysis with treatment initiation regardless of fibrosis stage

Strategy	QALY in the study population (a)	QALY in the HCV-RNA population	Average lifetime cost (€) (c)	ICER* (€/QALY) (c)/(a)
-5%-variation				
S1 = Risk-based strategy	21.307800	17.786905	79.16	
S3 = S1 and all 40-59	21.307863	17.826463	81.37	Dominated [†]
S2 = S1 and all men 18-59	21.307927	17.862278	82.08	Dominated [†]
S4 = S1 and all 40-80	21.308000	17.853643	83.73	22,900
S5 = all 18-80	21.308096	17.935635	86.89	32,900
+5%-variation				
S1 = Risk-based strategy	21.308604	18.253021	75.35	
S3 = S1 and all 40-59	21.308673	18.296979	77.53	Dominated [†]
S2 = S1 and all men 18-59	21.308745	18.336772	78.23	Dominated [†]
S4 = S1 and all 40-80	21.308826	18.327184	79.82	20,100
S5 = all 18-80	21.308932	18.418286	82.95	29,500

*The comparator for each ICER is the previous least costly strategy; [†]Weakly dominated strategy:

higher ICER than that of a more effective alternative strategy.

Supplementary Table 20 – Sensitivity analysis using alternative distribution of the study population [13]: cost-effectiveness analysis with treatment initiation regardless of fibrosis stage.

Strategy	QALY in the study population (a)	QALY in the HCV-RNA population	Average lifetime cost (€) (c)	ICER* (€/QALY) (c)/(a)
S1 = Risk-based strategy	23.033705	19.614233	50.26	
S3 = S1 and all 40-59	23.033788	19.670585	52.65	Dominated [†]
S2 = S1 and all men 18-59	23.033831	18.694380	53.26	Dominated [†]
S4 = S1 and all 40-80	23.033853	19.683609	53.69	23,200
S5 = all 18-80	23.033917	19.777793	57.18	54,500

*The comparator for each ICER is the previous least costly strategy; [†]Weakly dominated strategy: higher ICER than that of a more effective alternative strategy.

Supplementary Table 21 – Sensitivity analysis of results considering costs related to severe anemia leading to transfusion for patients initiating ribavirin [25]: cost-effectiveness analysis with treatment initiation regardless of fibrosis stage

Strategy	QALY in the study population (a)	QALY in the HCV-RNA population	Average lifetime cost (€) (c)	ICER* (€/QALY) (c)/(a)
S1 = Risk-based strategy	21.308202	18.019951	77.28	
S3 = S1 and all 40-59	21.308268	18.127596	79.47	Dominated [†]
S2 = S1 and all men 18-59	21.308336	18.221902	80.18	Dominated [†]
S4 = S1 and all 40-80	21.308413	18.192617	81.80	21,400
S5 = all 18-80	21.308514	18.413285	84.94	31,100

*The comparator for each ICER is the previous least costly strategy; [†]Weakly dominated strategy: higher ICER than that of a more effective alternative strategy; [‡]strongly dominated strategies: more expensive and less effective.

Supplementary Table 22 – Bivariate sensitivity analysis of increasing screening uptake from 50% to 100% and cost of screening (Hepatitis C antibody test, HCV-RNA test) from 0% to 20%: average lifetime cost per person for the universal strategy and ICER for the universal screening strategy compared to the strategy targeting all individuals 40-80.

		Increase in cost of testing					
		0%	5%	10%	15%	20%	
Increase in uptake of universal screening	50%	Cost*	84.92	85.42	85.91	86.40	86.90
		ICER†	31,100	32,500	33,800	35,100	36,300
	60%	Cost*	87.19	87.79	88.38	88.97	89.56
		ICER†	31,200	32,600	33,900	35,200	36,400
	70%	Cost*	89.47	90.16	91.85	91.54	92.23
		ICER†	31,500	32,800	34,100	35,400	36,700
	80%	Cost*	91.74	92.53	93.32	94.11	94.90
		ICER†	31,500	32,800	34,100	35,400	36,700
	90%	Cost*	94.01	94.90	95.79	96.68	97.57
		ICER†	31,400	32,800	34,100	35,400	36,700
	100%	Cost*	96.29	97.27	98.26	99.25	100.24
		ICER†	31,500	32,700	34,100	35,400	36,700

* Average lifetime cost per person in euros for universal screening; †ICER in euros/QALY for universal screening compared to the strategy targeting all individuals 40-80.

Supplementary References

- [1] The French METAVIR Cooperative Study Group. Intraobserver and interobserver variations in liver biopsy interpretation in patients with chronic hepatitis C. *Hepatology* 1994;20:15-20.
- [2] Poynard T, Ratziu V, Charlotte F, Goodman Z, McHutchison J, Albrecht J. Rates and risk factors of liver fibrosis progression in patients with chronic hepatitis c. *J Hepatol* 2001;34:730-739.
- [3] Serfaty L, Aumaitre H, Chazouilleres O, Bonnand AM, Rosmorduc O, Poupon RE, et al. Determinants of outcome of compensated hepatitis C virus-related cirrhosis. *Hepatology* 1998;27:1435-1440.
- [4] Corrao G, Arico S. Independent and combined action of hepatitis C virus infection and alcohol consumption on the risk of symptomatic liver cirrhosis. *Hepatology* 1998;27:914-919.
- [5] Degos F, Christidis C, Ganne-Carrié N, Farmachidi J-P, Degott C, Guettier C, et al. Hepatitis C virus related cirrhosis: time to occurrence of hepatocellular carcinoma and death. *Gut* 2000;47:131-136.
- [6] Davis GL, Alter MJ, El-Serag H, Poynard T, Jennings LW. Aging of hepatitis C virus (HCV)-infected persons in the United States: a multiple cohort model of HCV prevalence and disease progression. *Gastroenterology* 2010;138:513-521.
- [7] Deuffic-Burban S, Mathurin P, Pol S, Larsen C, Roudot-Thoraval F, Desenclos JC, et al. Impact of hepatitis C triple therapy availability upon the number of patients to be treated and associated costs in France: a model-based analysis. *Gut* 2012;61:290-296.
- [8] Mourad A, Deuffic-Burban S, Ganne-Carrié N, Renaut-Vantroys T, Rosa I, Bouvier AM, et al. HCC screening in patients with compensated HCV-related cirrhosis aware of their HCV-status improves survival: a modeling approach. *Hepatology* 2014;59:1471-1481.

- [9] D'Amico G, Garcia-Tsao G, Pagliaro L. Natural history and prognostic indicators of survival in cirrhosis: a systematic review of 118 studies. *J Hepatol* 2006;44:217-231.
- [10] Agence de la Biomédecine. Rapport annuel 2011. Saint-Denis La Plaine; 2011.
- [11] World Health Organization. Global Health Observatory Data Repository. Life Tables by country, France. 2013 [cited September 22, 2015]; Available from: <http://apps.who.int/gho/data/view.main.60580>
- [12] Meffre C, Le Strat Y, Delarocque-Astagneau E, Dubois F, Antona D, Lemasson JM, et al. Prevalence of hepatitis B and hepatitis C virus infections in France in 2004: social factors are important predictors after adjusting for known risk factors. *J Med Virol* 2010;82:546-555.
- [13] Brouard C, Le Strat Y, Larsen C, Jauffret-Roustide M, Lot F, Pillonel J. The undiagnosed chronically-infected HCV population in France. Implications for expanded testing recommendations in 2014. *PLoS One* 2015;10:e0126920.
- [14] Assurance Maladie. Nomenclature générale des actes professionnels (NGAP) restant en vigueur depuis la décision UNCAM du 11 mars 2005. 2015 [cited July 22, 2015]; Available from: http://www.ameli.fr/fileadmin/user_upload/documents/NGAP.pdf
- [15] Assurance Maladie. Classification commune des actes médicaux. 2015 [cited July 22, 2015]; Available from: http://www.ameli.fr/fileadmin/user_upload/documents/CCAM_V40.pdf
- [16] Agence Technique de l'Information sur l'Hospitalisation. Manuel des GHM - Version définitive 11g. 2015 [cited July 23, 2015]; Available from: <http://www.atih.sante.fr/manuel-des-ghm-version-definitive-11g>
- [17] Cossais S, Schwarzingler M, Deuffic-Burban S, Pol S, Fontaine H, Larrey D, et al. EQ-5D utility index in french patients with chronic hepatitis C (CHC) infection: severe comorbidities and perceived progression of CHC infection matter more than actual liver disease stage (P0745). *J Hepatol* 2015;62:S605.

- [18] Chevalier J, de Pourville G. Valuing EQ-5D using time trade-off in France. *Eur J Health Econ* 2013;14:57-66.
- [19] Pol S, Chevalier J, Branchoux S, Perry R, Milligan G, Gaudin A-F. Health related quality of life and utility values in chronic hepatitis C patients: A cross-sectional study in France, the Uk and Germany (P0747). *J Hepatol* 2015;62:S606.
- [20] Prise en charge thérapeutique et suivi de l'ensemble des personnes infectées par le virus de l'hépatite C. Rapport de recommandations 2016: Sous la direction du Pr Daniel Dhumeaux. Sous l'égide de l'ANRS et du CNS et avec le concours de l'AFEF.
- [21] Mourad A, Deuffic-Burban S, Ganne-Carrie N, Renaut-Vantroys T, Rosa I, Bouvier AM, et al. Hepatocellular carcinoma screening in patients with compensated hepatitis C virus (HCV)-related cirrhosis aware of their HCV status improves survival: a modeling approach. *Hepatology* 2014;59:1471-1481.
- [22] van der Meer AJ, Veldt BJ, Feld JJ, Wedemeyer H, Dufour JF, Lammert F, et al. Association between sustained virological response and all-cause mortality among patients with chronic hepatitis C and advanced hepatic fibrosis. *JAMA* 2012;308:2584-2593.
- [23] Agence Nationale d'Accréditation et d'Evaluation en Santé (ANAES). Hepatitis C screening - populations to be screened and screening procedures. Recommendations of the Experts Committee set up by the ANAES; 2001.
- [24] Schwarzing M, Deuffic-Burban S, Mallet V, Pol S, Pageaux GP, Canva-Delcambre V, et al. Lifetime costs attributable to chronic hepatitis C from the French healthcare perspective (Anrs N°12188). *J Hepatol* 2013;58:S21-22.
- [25] Agence Technique de l'Information sur l'Hospitalisation. Le programme de médicalisation des systèmes d'information en médecine, chirurgie, obstétrique et odontologie. [cited July 22, 2015]; Available from: <http://www.atih.sante.fr/mco/presentation>.