



HAL
open science

FHL1 is a major host factor for chikungunya virus infection

Laurent Meertens, Mohamed Lamine Hafirassou, Thérèse Couderc, Lucie Bonnet-Madin, Vasiliya Kril, Beate Mareike Kümmerer, Athena Labeau, Alexis Brugier, Etienne Simon-Loriere, Julien Burlaud-Gaillard, et al.

► **To cite this version:**

Laurent Meertens, Mohamed Lamine Hafirassou, Thérèse Couderc, Lucie Bonnet-Madin, Vasiliya Kril, et al.. FHL1 is a major host factor for chikungunya virus infection. *Nature*, 2019, 574 (7777), pp.259-263. 10.1038/s41586-019-1578-4 . inserm-02355424v2

HAL Id: inserm-02355424

<https://inserm.hal.science/inserm-02355424v2>

Submitted on 9 Feb 2023

HAL is a multi-disciplinary open access archive for the deposit and dissemination of scientific research documents, whether they are published or not. The documents may come from teaching and research institutions in France or abroad, or from public or private research centers.

L'archive ouverte pluridisciplinaire **HAL**, est destinée au dépôt et à la diffusion de documents scientifiques de niveau recherche, publiés ou non, émanant des établissements d'enseignement et de recherche français ou étrangers, des laboratoires publics ou privés.



Distributed under a Creative Commons Attribution - NonCommercial 4.0 International License

1 **FHL1 is a major host factor for chikungunya virus infection**

2 Laurent Meertens^{1#*}, Mohamed Lamine Hafirassou¹, Therese Couderc², Lucie
3 Bonnet-Madin¹, Vasiliya Kril¹, Beate M. Kümmerer³, Athena Labeau¹, Alexis Brugier¹,
4 Etienne Simon-Lorier⁴, Julien Burlaud-Gaillard⁵, Cécile Doyen⁶, Laura Pezzi⁷,
5 Thibaud Goupil², Sophia Rafasse², Pierre-Olivier Vidalain⁸, Anne Bertrand Legout⁹,
6 Lucie Gueneau⁹, Raul Juntas-Morales¹⁰, Rabah Ben Yaou⁹, Gisèle Bonne⁹, Xavier de
7 Lamballerie⁷, Monsef Benkirane⁶, Philippe Roingard⁵, Constance Delaugerre^{1,11},
8 Marc Lecuit^{2,12} and Ali Amara^{1#*}

9
10 ¹ Cell Biology of Virus Infection Team, INSERM U944, CNRS UMR 7212, Institut de
11 Recherche Saint-Louis, Université de Paris, Hôpital Saint-Louis, 75010 Paris, France

12
13 ² Biology of Infection Unit, Institut Pasteur, Inserm U1117, Paris, France

14
15 ³ Institute of Virology, University of Bonn Medical Centre, Bonn, Germany

16
17 ⁴ G5 Evolutionary Genomics of RNA Viruses, Institut Pasteur, 28 rue du Dr Roux,
18 75724 Paris, France

19
20 ⁵ INSERM U1259 MAVIVH et Plateforme IBISA de Microscopie Electronique,
21 Université de Tours, France

22
23 ⁶ Institut de Génétique Humaine, Laboratoire de Virologie Moléculaire, CNRS-
24 Université de Montpellier, 34000 Montpellier, France

25
26 ⁷ Unité des Virus Émergents, Aix-Marseille Univ–IRD190–Inserm 1207
27 EFS-IRBA, 13005 Marseille cedex 05, France

28
29 ⁸ Equipe Chimie & Biologie, Modélisation et Immunologie pour la Thérapie, Université
30 Paris Descartes, CNRS UMR 8601, Paris, France

31
32 ⁹ Sorbonne Université, INSERM UMRS974, Center of Research in Myology, F-75013
33 Paris, France.

34
35 ¹⁰ Département de Neurologie, Centre Hospitalier Universitaire de Montpellier,
36 Montpellier, France.

37
38 ¹¹ Laboratoire de Virologie et Département des Maladies Infectieuses, Hôpital Saint-
39 Louis, APHP, 75010 Paris, France

40
41 ¹² Université de Paris, Department of Infectious Diseases and Tropical Medicine,
42 Necker-Enfants Malades University Hospital, APHP, Institut Imagine, Paris, France

43
44 # Contributed equally to the work

45 * Corresponding authors: ali.amara@inserm.fr; laurent.meertens@inserm.fr

46 **ABSTRACT**

47 Chikungunya virus (CHIKV) is a re-emerging Old World alphavirus transmitted to
48 humans by mosquito bites which causes musculoskeletal and joint pain¹⁻³. Despite
49 intensive investigations, the identity of the human cellular factors critical for CHIKV
50 infection remains elusive, hampering both the understanding of viral pathogenesis and
51 the development of anti-CHIKV therapies. Here, we identified the Four-and-a-Half LIM
52 domain protein 1 (FHL1)⁴ as a host factor required for CHIKV permissiveness and
53 pathogenesis. Ablation of FHL1 expression results in massive inhibition of infection by
54 several CHIKV strains and O'nyong-nyong virus, but not by other alphaviruses or
55 flaviviruses. Conversely, expression of FHL1 enhances infection of cells that do not
56 express it and are poorly susceptible to CHIKV. We show that FHL1 directly interacts
57 with the hypervariable domain of CHIKV nsP3 protein and is essential for viral RNA
58 replication. FHL1 is highly expressed in CHIKV target cells and particularly abundant
59 in muscles^{4,5}. Significantly, dermal fibroblasts and muscle cells derived from Emery-
60 Dreifuss muscular dystrophy (EDMD) patients which lack functional FHL1⁶ are
61 resistant to CHIKV infection. Importantly, CHIKV infection is undetectable in mice
62 knocked out for the FHL1 gene. Overall, this study shows that FHL1 is a key host
63 dependency factor for CHIKV infection and identifies nsP3-FHL1 interaction as a
64 promising target for the development of anti-CHIKV therapies.

65

66 **MAIN TEXT**

67 Several host factors implicated in CHIKV infection have been identified, however
68 none of them accounts for CHIKV tropism for joint and muscle tissues⁷⁻¹⁰. To identify
69 key host factors dictating CHIKV cell permissiveness, we performed a genome-wide
70 CRISPR-Cas9 screen in the HAP1 haploid cell line (Fig.1a, Extended Data Fig. 1).
71 HAP1 cells expressing the human GeCKO v2 single guide RNA libraries A and B,
72 which contains each 3 unique sgRNAs targeting 19,050 genes¹¹, were inoculated with
73 CHIKV21, a strain isolated from a patient infected during the 2005-2006 CHIKV
74 outbreak in La Reunion Island¹². Genomic DNA from lentivirus-transduced cells that
75 survived to CHIKV infection was isolated, amplified and the corresponding integrated
76 sgRNA sequenced. Gene enrichment was assessed using the MAGeCK software¹³
77 (Fig.1a, Extended Data Fig. 1, supplementary Table 1). The top hit of our screen was
78 the gene encoding the Four-and-a-Half LIM protein 1 (FHL1) (Fig.1a, Extended Data
79 Fig. 2a-c), the founding member of the FHL protein family¹⁴. FHL1 is characterized by
80 the presence of four and a half highly conserved LIM domains with two zinc fingers
81 arranged in tandem¹⁴. FHL1 is strongly expressed in skeletal muscles and heart^{4,14}. In
82 human, there are three FHL1 splice variants: FHL1A, FHL1B and FHL1C^{4,15,16}. FHL1A
83 is the most abundantly expressed, primarily detected in striated muscles⁴ and
84 fibroblasts¹⁷. The two other variants FHL1B and C are expressed in muscles, brain and
85 testis^{15,16}. We functionally validated the requirement of FHL1 in CHIKV21 infection by
86 using two distinct gRNAs targeting all three FHL1 isoforms (Extended Data Fig. 2a).
87 We generated HAP1 and 293T knockout *FHL1* clones (Δ FHL1) and confirmed gene
88 editing by sequencing and western blot analysis (Extended Data Fig. 2d, e, f). FHL1
89 knockout did not alter cell proliferation and viability as determined by CellTiter-Glo
90 assay (Extended Data Fig. 2g). CHIKV infection and release of infectious particles was

91 drastically inhibited in Δ FHL1 cells (Fig.1b, Extended Data Fig. 3a-d). Trans-
92 complementation of Δ FHL1 cells with a human cDNA encoding FHL1A, but not FHL1B
93 or C, restored both susceptibility to CHIKV21 infection and virus release (Fig. 1c,
94 Extended Data Fig. 4a-b), indicating that FHL1A is a critical factor for CHIKV21
95 infection. Expression of FHL2, a member of the FHL family predominantly expressed
96 in heart¹⁸, restored CHIKV infection in Δ FHL1 cells, albeit to a lower efficiency than
97 FHL1 (Extended Data Fig. 4c). We then assessed FHL1 dependency of CHIKV strains
98 from distinct genotypes. FHL1 is important for infection by strains belonging to the
99 Asian (strain St Martin H20235 2013), the ECSA (East, Central, and South African)
100 strains Ross and Brazza (MRS1 2011) and the Indian Ocean (IOL) (strain M-899)
101 lineages (Fig. 1d). Of note, the requirement for FHL1 was less pronounced with CHIKV
102 37997, a strain from the West African genotype (Fig. 1d). We next tested the
103 requirement of FHL1 for infection by other alphaviruses. Interestingly, O'nyong-nyong
104 virus (ONNV), an Old World alphavirus that is phylogenetically very close to CHIKV¹,
105 showed a dramatically reduced infection level in Δ FHL1 cells (Fig.1e, Extended Data
106 Fig. 3e). In sharp contrast, other Old World alphaviruses such as Mayaro virus (MAYV),
107 Sindbis virus (SINV), Semliki Forest Virus (SFV) and Ross River virus (RRV), and New
108 World encephalitic viruses such as Eastern equine encephalitis virus (EEEV), Western
109 equine encephalitis virus (WEEV) or Venezuelan equine encephalitis virus (VEEV)
110 infected HAP1 cells in a FHL1-independent manner (Fig. 1e, f, Extended Data Fig. 3e).
111 No effect of FHL1 was observed for infection by Dengue virus (DENV) or Zika virus
112 (ZIKV), two members of the *Flavivirus* genus (Fig. 1g, Extended Data Fig. 3f).
113 Consistent with the requirement of FHL1 for CHIKV infection, BeWo or HepG2 cells
114 which are poorly susceptible to CHIKV infection^{20,21} and do not express endogenous
115 FHL1 (Extended Data Fig. 5a) became permissive to the virus upon FHL1A expression

116 (Fig.1h, Extended Data Fig. 5b-d). This highlights the major role played by FHL1A in
117 human cell permissiveness to CHIKV.

118 To determine which step in CHIKV life cycle requires FHL1, we challenged
119 parental and Δ FHL1 cells with CHIKV particles and quantified the viral RNA at different
120 time points (Fig. 2a). We did not observe any major difference in CHIKV RNA levels in
121 FHL1-deficient cells compared to WT cells at 2h post-infection (Fig. 2a). In contrast, a
122 massive reduction of CHIKV RNA was observed in Δ FHL1 cells as early as 6h post-
123 infection (Fig. 2a) which was even greater 24h post-infection, suggesting that FHL1
124 expression is involved in an early post-entry step of the CHIKV life cycle. We therefore
125 bypassed virus entry and uncoating by transfecting CHIKV RNA into controls or Δ FHL1
126 cells in the presence of NH_4Cl to inhibit further rounds of infection⁹. Upon CHIKV RNA
127 transfection, viral replication was drastically impaired in Δ FHL1 cells compared to WT
128 cells (Fig. 2b, Extended Data Fig 6a). To evaluate the contribution of FHL1 in incoming
129 genome translation versus RNA replication, we generated a replication-deficient
130 CHIKV molecular clone (with the GDD motif of the viral polymerase nsP4 mutated to
131 GAA) encoding a *Renilla* luciferase (Rluc) fused to the nsP3 protein as described²².
132 Transfection of CHIKV GAA RNA in Δ FHL1 or control cells resulted in a similar Rluc
133 activity (Fig. 2c), indicating that FHL1 is dispensable for CHIKV incoming RNA
134 translation. When similar experiments were performed with the WT CHIKV RNA, a
135 massive increase in Rluc activity was observed in control cells but not Δ FHL1 24 hpi
136 (Fig. 2d), demonstrating that FHL1 is essential for viral RNA replication. Furthermore,
137 qRT-PCR experiments showed that ablation of FHL1 resulted in a severely reduced
138 synthesis of CHIKV negative strand RNA (Fig. 2e). We then investigated the impact of
139 FHL1 in the production of dsRNA intermediates which are a marker of viral replication
140 complex (vRC) assembly²³. At 6h post-infection, a massive reduction of dsRNA-

141 containing complexes was observed in Δ FHL1 cells stained with anti-dsRNA mAb
142 when compared to parental cells (Fig. 2f). Consistent with this observation,
143 transmission electron microscopy showed that the formation of plasma membrane-
144 associated spherules and cytoplasmic vacuolar membrane structures, which are
145 alphavirus-induced platforms required for viral RNA synthesis²⁴, are absent in Δ FHL1
146 cells (Fig 2g). Altogether, these data show that FHL1 is critical for CHIKV RNA
147 replication and vRC formation in infected cells.

148 We next investigated FHL1 location during infection. Confocal microscopy
149 studies showed that FHL1 displays a diffuse cytoplasmic distribution in uninfected
150 human fibroblasts. In cells infected for 6h, FHL1-containing foci appeared and
151 colocalized with nsP3 (Extended Data Fig. 6b), a CHIKV non-structural protein
152 orchestrating viral replication in the cytoplasm^{25,26}. Indeed, CHIKV nsP3 contains a
153 large C-terminal hypervariable domain (HVD)²⁵ known to mediate assembly of protein
154 complexes and regulate RNA amplification^{25,26}. Interestingly, FHL1 and FHL2 have
155 been reported as putative nsP3 HVD binding partners in mass spectrometry analyses
156 ^{26,27}. We experimentally validated FHL1-nsP3 interaction (Fig. 2h,i; Extended Data Fig.
157 6c-g) and found that endogenous FHL1 co-immunoprecipitates with nsP3 from CHIKV-
158 infected cells (Fig. 2h). Consistent with infection studies, both FHL1A and FHL2 co-
159 precipitated with CHIKV nsP3 (Extended Data Fig. 6d). FHL1A-nsP3 interaction is
160 specific for CHIKV as it was not observed with other alphaviruses such as SINV or
161 SFV, which do not depend on FHL1 for infection (Extended Data Fig. 6e). Of note, in
162 Δ FHL1 cells, nsP3 retained its ability to bind G3BP1 and 2, two components of the
163 stress granules implicated in CHIKV replication^{22,26} (Extended Data Fig. 6e). We next
164 generated chimeric proteins where the HVD region of CHIKV nsP3 is swapped with
165 the corresponding domain of SINV nsP3 and vice versa. Whereas CHIKV-SINV(HVD)

166 chimeric protein lost its ability to bind FHL1, the HVD of CHIKV in the context of SINV
167 nsP3 protein conferred binding to FHL1 (Extended Data Fig. 6f). Pull-down
168 experiments with purified proteins showed that FHL1A directly binds to WT nsP3 but
169 not to the HVD-deficient variant (Fig. 2i, Extended Data Fig. 6g). We then mapped the
170 binding region within CHIKV nsP3HVD responsible for FHL1A interaction (Fig. 2j,
171 Extended Data Fig. 7). The FHL1 binding domain, referred as HVD-R4, is found in all
172 CHIKV and ONNV strains and is located upstream of the short repeating peptide
173 corresponding to G3BP1/2 binding sites²⁶ (Fig. 2j, Extended Data Fig. 7a). Deletion of
174 the HVD-R4 region strongly impaired FHL1 interaction with nsP3, without affecting
175 G3BP1/2 binding to the viral protein (Fig. 2j, Extended Data Fig. 7b). To investigate
176 whether FHL1 interaction with the HVD region of nsP3 is required for FHL1 proviral
177 role, we generated two chimeric FHL1A protein either fused to the HVD-R4 peptide
178 (FHL1A-R4) or to a randomized peptide sequence of HVD-R4 (FHL1A-R4*) as a
179 positive control (Fig. 2k, Extended Data Fig. 7c) and assessed their ability to interact
180 with nsP3. Whereas FHL1A-R4 failed to bind nsP3 (Fig. 2k), FHL1A-R4* interacted
181 with nsP3 as efficiently as WT FHL1A protein (Fig. 2k). These results indicate that the
182 fused HVD-R4 peptide likely hides the binding site of FHL1A to nsP3, inhibiting their
183 interaction. Furthermore, trans-complementation of Δ FHL1 cells with a cDNA encoding
184 FHL1A-R4 did not restore CHIKV21 infection when compared to FHL1A-R4* or WT
185 FHL1A (Fig. 2l). Consistent with this, *in vitro* transcribed RNA from CHIKV molecular
186 clone mutated in FHL1 binding site (Δ R4 or R4*) showed a strong defect in replication
187 after transfection in 293T cells (Extended Data Fig. 7d). Together these data strongly
188 suggest that the interaction between the HVD region of nsP3 with FHL1 is critical for
189 FHL1 proviral function.

190 Mutations in the *FHL1* gene have been associated with X-linked myopathies^{5,28},
191 including the Emery–Dreifuss muscular dystrophy (EDMD)⁶, a rare genetic disease
192 characterized by early joint contractures, muscular wasting and adult-onset cardiac
193 disease²⁹. We studied the permissiveness to CHIKV of dermal fibroblasts and
194 myoblasts from four EDMD male patients carrying *FHL1* gene mutations as well as
195 from two healthy donors (Extended Data Fig.8a). A detailed clinical description of P1,
196 P2 and P3 has been reported⁶, and patient P4 presented with EDMD and additional
197 clinical abnormalities (see methods). Analysis of P4 *FHL1* gene revealed the insertion
198 of a full-length LINE-1 retrotransposon sequence in exon 4 (Extended Data Fig.8b).
199 *FHL1* expression is severely reduced in primary cells from all four EDMD patients as
200 established by immunoblot analysis (Fig. 3a). Infection studies showed that fibroblasts
201 and myoblasts from those EDMD patients are resistant to CHIKV21 and M-899
202 Mauritian strains (Fig. 3b-d, Extended Data Fig.8c), and exhibit a massive defect in the
203 release of infectious particles (Fig. 3d), in contrast to healthy donor cells. Similar results
204 were obtained with the CHIKV strains Brazza, Ross and H20235 (Fig. 3e, Extended
205 Data Fig.8d). *FHL1*-null myoblasts and fibroblasts remained highly susceptible to
206 MAYV, which does not rely on *FHL1* for replication (Fig. 3e). Trans-complementation
207 of EDMD fibroblasts by a lentivirus encoding WT *FHL1A* restored CHIKV viral antigen
208 synthesis (Fig. 3f, Extended Data Fig.8e) and infectious particle release (Fig. 3g).

209 To directly assess the role of *FHL1* in chikungunya pathogenesis, we conducted
210 *in vivo* experiments in mice expressing or not *FHL1*. Human and mouse *FHL1*
211 orthologues are highly conserved (Extended Data Fig.9a). Murine *FHL1* interacts with
212 CHIKV nsP3 and enhances viral infection, albeit less efficiently than its human
213 orthologue (Extended Data Fig.9 b-d). Moreover, CHIKV infection was strongly
214 impaired in the murine muscle cell C2C12 deleted for the *fh11* gene (Extended Data

215 Fig.9 e-f). Susceptibility to CHIKV infection of young mice deficient or not for FHL1 was
216 then tested. CHIKV actively replicated in tissues of WT littermates, as previously
217 reported²⁰, but virtually no infectious particles were detected in tissues of FHL1-null
218 mice (Fig. 4a). Moreover, necrotizing myositis with massive infiltrates and necrosis of
219 the muscle fibers were observed in skeletal muscle of WT littermates, while FHL-null
220 mouse muscle showed no detectable pathology (Fig. 4b). Immunolabelling with Ab
221 against CHIKV E2 protein, FHL1 and vimentin in muscle revealed that in young WT
222 mice, CHIKV mainly targets muscle fiber expressing FHL1, whereas muscle cells of
223 FHL1-null mice show no label for CHIKV nor for FHL1 (Fig. 4c). These experiments
224 demonstrate that *FHL1* knock out mice are resistant to CHIKV infection.

225 In summary, this study shows that FHL1 is a critical CHIKV host dependency
226 factor for infection and pathogenesis. *In vivo*, FHL1 expression pattern, which accounts
227 for the clinical presentation of EDMD, also reflects CHIKV tissue tropism for skeletal
228 muscles and joints. This suggests that the hijacking of FHL1 by CHIKV during infection
229 may, on top of allowing viral replication, lead to cellular dysfunctions contributing to
230 muscular and joint pains that are the hallmark of chikungunya disease^{1,2}.
231 Mechanistically, FHL1 interacts with the HVD domain of nsP3 to enable viral RNA
232 synthesis and viral replication complex formation. The alphavirus nsP3 HVD domain is
233 an intrinsically disordered region that binds distinct sets of cellular proteins^{23,26,30} such
234 as the G3BP1 and G3PB2, two key components and markers of stress granules that
235 are important for the replication of CHIKV and other alphaviruses^{22,26}. G3BP1/2 nsP3
236 interactions are thought drive a common alphavirus-specific mechanism that is
237 important for assembly of the replication complex and stabilization of viral G
238 RNA^{22,23,26}. FHL1 interacts with a nsP3 HVD region which is located away from
239 G3BP1/2 binding sites. Therefore, FHL1 and G3BP proteins likely play distinct roles

240 during CHIKV replication. In contrast to G3BPs, FHL1 is selectively used by CHIKV,
241 suggesting that it may accomplish a specific and essential function in CHIKV RNA
242 amplification. Upon interaction with FHL1, CHIKV nsP3 HVD may adopt a unique
243 conformation that is critical for the initiation of viral replication. Interestingly, intrinsically
244 disordered domains (IDD) such as the nsP3 HVD have also been shown to induce
245 liquid-liquid phase separations³¹ and negative-stranded RNA viruses use proteins
246 displaying IDDs to form liquid organelles for their replication³². Indeed, in CHIK-infected
247 cells, nsP3 forms intracellular granules reminiscent of these virus-induced inclusions
248 ^{33,34}. FHL1 may regulate the formation and/or the dynamic of such granules to create
249 an optimal environment for efficient CHIKV RNA amplification. FHL1 contains four LIM
250 domains arranged in tandem known to function as a modular protein binding interface
251 regulating diverse cellular pathways³⁵. FHL1 has been shown to scaffold MAPK
252 components (Raf-1/MEK2/ERK2) to the stretch sensor Titin N2B to transmit MAPK
253 signals that regulate muscle compliance and cardiac hypertrophy^{36,37}. One may
254 speculate that, during CHIKV infection, FHL1 may be hijacked from its physiological
255 function in sarcomere extensibility and intracellular signaling to act as scaffolding
256 protein promoting CHIKV RNA amplification.

257 In conclusion, this study provides major insights into the understanding of
258 CHIKV interactions with its target host cell. Although other host-factors have been
259 identified as required for CHIKV infection, none of them fully account for the specific
260 joint and muscular pathology which is the hallmark of CHIKV and gave its name to its
261 associated disease, chikungunya, which means “that which bends up” in Makonde, to
262 describe the posture of patient with muscle and joint pain. The hijacking of FHL1 by
263 nsP3 during CHIKV infection is unique and constitutes a critical clue that paves the
264 way to fully decipher the pathogenesis of chikungunya disease. Targeting FHL1A–

265 nsP3 interactions now stands as an attractive therapeutic approach to combat CHIKV

266 pathogenesis.

267

268 **METHODS**

269 **Cell culture.** HAP1 cells (Horizon Discovery), which are derived from near-haploid
270 chronic myeloid leukemia KBM7 cells, were cultured in IMDM supplemented with 10%
271 FBS, 1% penicillin-streptomycin (P/S) and GlutaMAX (Thermo Fisher Scientific).
272 293FT (Thermo Fisher Scientific), HEK-293T (ATCC), Vero E6 (ATCC), HepG2 (kind
273 gift of Olivier Schwartz, Institut Pasteur, Paris, France), primary myoblasts and primary
274 fibroblasts were cultured in DMEM supplemented with 10% FBS, 1% penicillin-
275 streptomycin, 1% GlutaMAX and 25 mM HEPES. Human placenta choriocarcinoma
276 Bewo cells were cultured in DMEM supplemented with 5% FBS, 1% penicillin-
277 streptomycin, 1% GlutaMAX and 25 mM HEPES. AP61 mosquito (*Aedes*
278 *pseudoscutellaris*) cells (gift from Philippe Despres, Institut Pasteur, Paris, France)
279 were cultured at 28°C in Leibovitz medium supplemented with 10% FCS, 1% P/S, 1%
280 glutamine, 1X non-essential amino acid, 1X Tryptose phosphate and 10 mM HEPES.
281 All cell lines were cultured at 37°C in presence of 5% CO₂ with the exception of AP61
282 that were maintained at 28°C with no CO₂.

283

284 **Virus strains and culture.** CHIKV21 (strain 06-21), ZIKV (HD78788) (both are kind
285 gift from Philippe Despres, Institut Pasteur, Paris, France), CHIKV West Africa (strain
286 37997, accession nb AY726732.1) and dengue virus serotype 2 DENV (16681) viruses
287 were propagated in mosquito AP61 cell monolayers with limited cell passages. CHIKV-
288 Brazza-MRS1 2011, CHIKV-Ross, CHIKV-St Martin H20235 2013-Asian, RRV (strain
289 528v), MAYV (strain TC 625), ONNV (strain Dakar 234), SINV (strain Egypt 339),
290 EEEV (strain H178/99), VEEV (strain TV83 vaccine), WEEV (strain 47A), SFV (strain
291 1745) were obtained from the European Virus Archive (EVA) collection and propagated
292 with limited passage on Vero E6 cells.

293 pCHIKV-M-Gluc (see plasmid sections) and pCHIKV-mCherry molecular clones were
294 derivate of pCHIKV-M constructed from a CHIKV (strain BNI-CHIKV_899) isolated
295 from a patient during Mauritius outbreak in 2006. To generate infectious virus from
296 CHIKV molecular clones, capped viral RNAs were generated from the NotI-linearized
297 CHIKV plasmids using a mMESSAGE mMACHINE SP6 or T7 Transcription Kit
298 (Thermo Fischer Scientific) according to manufacturer's instructions. Resulting RNAs
299 were purified by phenol:chloroform extraction and isopropanol precipitation,
300 resuspended in water, aliquoted and stored at -80°C until use. Thirty µg of purified
301 RNAs were transfected in BHK21 with lipofectamine 3000 reagent and supernatants
302 harvested 72 hours later were used for viral propagation on Vero E6 cells.
303 For all the viral stock used in flow cytometry analysis experiments, viruses were
304 purified through a 20% sucrose cushion by ultracentrifugation at 80,000xg for 2 hours
305 at 4°C. Pellets were resuspended in HNE1X pH7.4 (Hepes 5 mM, NaCl 150 mM, EDTA
306 0.1 mM), aliquoted and stored at -80°C. Viral stock titers were determined on Vero E6
307 cell by plaque assay and are expressed as PFU per ml. Virus stocks were also
308 determined by flow cytometry as previously described^{38,39} Briefly, Vero E6 cells were
309 incubated for 1h with 100µl of 10-fold serial dilutions of viral stocks. The inoculum was
310 then replaced with 500µl of culture medium and the percent of E2 expressing cells was
311 quantified by flow cytometry at 8 hpi. Virus titers were calculated using the following
312 formula and expressed as FACS Infectious Units (FIU) per ml. [Titer (FIU/ml) =
313 (average % of infection) x (number of cells in well) x (dilution factor) / (ml of inoculum
314 added to cells)].

315

316 **Reagents.** . The following antibodies were used: anti-FHL1 mAb (ref MAB5938, R &
317 D Systems), anti-FHL1 rabbit Ab (ref NBP1-88745, Novus Biologicals), anti-vimentin

318 antibody (ab24525, abcam), anti-GAPDH mAb (ref SC-47724, Santa Cruz
319 Biotechnology), polyclonal rabbit anti-HA (ref 3724, Cell Signaling Technology), anti-
320 FLAG M2 mAb (ref F1804, SIGMA), anti-RFP (ref 6G6, Chromotek), anti-CHIKV E2
321 mAb (3E4 and 3E4 conjugated-CY3), anti-alphavirus E2 mAb (CHIK-265 was a kind
322 gift from Michael Diamonds, University school of medicine, St Louis, USA), anti-EEEV
323 E1 mAb (ref MAB8754, Sigma), anti-pan-flavivirus E protein mAb (4G2), anti-dsRNA
324 J2 mAb (Scicons), Alexa Fluor™ 488-conjugated goat anti-rabbit IgG (A11034,
325 Invitrogen), Alexa Fluor™-647-conjugated goat anti-chicken IgG (ab150175, abcam),
326 Alexa Fluor™ 488-conjugated goat anti-mouse IgG (115-545-003, Jackson
327 ImmunoResearch), Alexa Fluor™ 647-conjugated goat anti-mouse IgG (115-606-062,
328 Jackson ImmunoResearch), peroxydase-conjugated donkey anti-rabbit IgG (711-035-
329 152, Jackson ImmunoResearch), and anti-mouse/HRP (P0260, Dako Cytomotion).
330 FLAG magnetic beads (ref M8823, SIGMA), HA-magnetic beads (ref 88837, Thermo
331 Fisher Scientific) and anti-RFP coupled to magnetic agarose beads (RFP-Trap MA,
332 Chromotek) were used for immunoprecipitation experiments.

333

334 **CRISPR genetic screen.** The GeCKO v2 human CRISPR pooled libraries (A and B)
335 encompassing 123,411 different sgRNA targeting 19,050 genes (cloned in the
336 plentiCRISPR v2) were purchased from GenScript. Lentiviral production was prepared
337 independently for each half-library in 293FT cells by co-transfecting sgRNA plasmids
338 with psPAX2 (Kind gift from Nicolas Manel, Institut Curie, Paris, France) and pCMV-
339 VSV-G at a ratio of 4:3:1 with lipofectamine 3000 (Thermo Fisher Scientific).
340 Supernatants were harvested 48h after transfection, cleared by centrifugation (750 x
341 g for 10 min), filtered using a 0.45 µM filter and purified through a 20% sucrose cushion
342 by ultracentrifugation (80,000 x g for 2 hours at 4°C). Pellets were resuspended in

343 HNE1X pH7.4, aliquoted and stored at -80°C. HAP1 cells were transduced by
344 spinoculation (750 x g for 2 hours at 32°C) with each CRISPR-sgRNA lentiviral libraries
345 at a multiplicity of infection (MOI) of 0.3 and a coverage of 500 times the sgRNA
346 representation. Cells were selected with puromycin for 8 days and expanded. Sixty
347 million cells from each library were pooled and infected with CHIKV21 using a MOI of
348 1. Simultaneously forty million of non-infected pooled cells were pelleted and kept at -
349 80°C to serve as a reference of the library representation at time of infection.
350 Approximately 5 days after infection, cytopathic effect was detectable and surviving
351 cells were collected 2 weeks later. Genomic DNA was extracted from selected cells or
352 non-infected pooled cells using QIAamp DNA column (Qiagen), and inserted gRNA
353 sequences were amplified and subject to next generation sequencing on an Illumina
354 MiSeq (Plateforme MGX, Institut Génomique Fonctionnelle, Montpellier, France). gRNA
355 sequences were analyzed using the MAGeCK software¹³. Additionally, gRNA
356 sequences were analyzed using the RIGER software following previously published
357 recommendation⁴⁰.

358

359 **FHL1 editing.** FHL1 was validated using two independent sgRNA targeting the exon
360 3 and exon 4, which are common to all FHL1 isoforms. sgRNA1, 5'-
361 GAGGACTCCCCCAAGTGCAA-3' and sgRNA2, 5'-GCAGTCAA ACTTCTCCGCCA-3'
362 were cloned into the plasmid lentiCRISPR v2 according to Zhang lab's
363 recommendation. HAP1 and 293FT cells were transiently transfected with the plasmid
364 expressing individual sgRNA and selected with puromycin until all mock-transfected
365 cells died (approximately 72 hours). Transfected cells were used to ascertain gRNA-
366 driven resistance to CHIKV cytopathic effect, and clonal cell lines were isolated by
367 limiting dilution and assessed by immunoblot for FHL1 expression.

368

369 **Infection assay.** For infection quantification by flow cytometry analysis, cells were
370 plated in 24-well plates. Cells were infected for 24 (293T) or 48 hours (HAP1),
371 trypsinized and fixed with 2% (v/v) paraformaldehyde (PFA) diluted in PBS for 15 min
372 at room temperature. Cells were incubated for 30 min at 4°C with 1µg/ml of either the
373 3E4 anti-E2 mAb for CHIKV strains and ONNV) or the CHIKV 265 anti-E2 mAb for
374 MAYV or the anti-E1 mAb for EEEV or anti-pan-flavivirus E 4G2 for DENV and ZIKV.
375 Ab were diluted in permeabilization flow cytometry buffer (PBS supplemented with 5%
376 FBS, 0.5% (w/v) saponin, 0.1% Sodium azide). After washing, cells were incubated
377 with 1µg/ml of Alexa Fluor 488 or 647-conjugated goat anti-mouse IgG diluted in
378 permeabilization flow cytometry buffer for 30 min at 4°C. Acquisition was performed on
379 an Attune NxT Flow Cytometer (Thermo Fisher Scientific) and analysis was done by
380 using FlowJo software (Tree Star). To assess infectious viral particles release during
381 infection, cells were inoculated for 3 hours with viruses, washed once and then
382 maintained in culture medium over a 72-hour period. At indicated time points
383 supernatants were collected and kept at -80°C. Vero E6 cells were incubated with 10-
384 fold serial dilution of supernatant for 24 hours and E2 expression was quantified by
385 flow cytometry as described above.

386 For detection of infected cells by immunofluorescence, control and Δ FHL1 HAP1 cells
387 were plated on Lab-Tek II CC2 glass slide 8 wells (Nunc). Cells were inoculated with
388 CHIKV21 strain (MOI of 20) or CHIKV-nsP3-mCherry (MOI of 20) for 48 hours, then
389 washed thrice with cold PBS and fixed with 4% (v/v) PFA diluted in PBS for 20 min at
390 room temperature. CHIKV E2 protein was stained with the 3E4 mAb at 5 µg/ml,
391 followed by a secondary staining with 1µg/ml of Alexa 488-conjugated goat anti-mouse
392 IgG. Both antibodies were diluted in PBS supplemented with 3% (w/v) BSA and 0.1%

393 saponin. Slides were mounted with ProLong Gold antifade reagent containing 4,6-
394 diamidino-2-phenylindole (DAPI) for nuclei staining (Thermo Fisher Scientific).
395 For colocalization experiments, cells infected with CHIKV-nsP3-mCherry (MOI of 20)
396 were stained with 10 µg/ml of the anti-FHL1 mAb, followed by a secondary staining
397 with 1µg/ml of Alexa 488-conjugated goat anti-mouse IgG.
398 For detection of dsRNA foci, control and ΔFHL1 293T cells were plated on Lab-Tek II
399 CC2 glass slide 8 wells (Nunc) and infected with CHIKV21 strain (MOI of 50) for 4 or
400 6 hours. After fixation with 4% (v/v) PFA diluted in PBS, cells were stained with 5 µg/ml
401 of the anti-dsRNA mAb, followed by a secondary staining with 1µg/ml of Alexa 488-
402 conjugated goat anti-mouse IgG. Both antibodies were diluted in PBS supplemented
403 with 3% (w/v) BSA and 0.1% Triton 100X. Of note, no dsRNA foci were detectable at
404 4hpi.
405 Fluorescence microscopy images were acquired using a LSM 800 confocal
406 microscope (Zeiss).

407

408 **Plasmid constructions.** To generate the C-terminal HA-tagged FHL1 isoforms, the
409 cDNAs of FHL1A (NM_001449.4), FHL1B (XM_006724746.2) and FHL1C
410 (NM_001159703.1) were purchased from Genscript. Coding sequence (CDS) were
411 amplified with a common FHL1 Fwd primer 5'-
412 CCGGAGAATTCGCCGCCATGGCGGAGAAGTTTGACTGCCACTACTGC-3'; and
413 specific FHL1A Rev primer 5'-AATAGTTTAG**CGGGCCGCT**CAAGCGTAATCTGGAA
414 CATCGTATGGGTATCCTCCAGCGGCCGACAGCTTTTTGGCACAGTCGGGACAA
415 TACACTTGCTCC-3'; or FHL1B and C specific Rev primer 5'-
416 AATAGTTTAG**CGGGCCGCT**CAAGCGTAATCTGGAACATCGTATGGGTATCCTCCA
417 GCGGCCGACGGAGCATTTTTTGCAGTGGAAGCAGTAGTCGTGCC-3' (underline,

418 segment hybridizing with the target sequence; bold, restriction endonuclease site for
419 cloning); and cloned into pLVX-IRES-ZsGreen1 vector (Takara). Using the same
420 approach, coding sequence of murine FHL1 (NM_001077362.2) was amplified with a
421 mFHL1 Fwd primer 5'-CCGGAGAATTCGCCGCCATGGCTTCTCAAAGACACTCAG
422 GTCCCTCC-3' and mFHL1 Rev primer 5'-AATAGTTTAGCGGCCGCTCAAGCGTAA
423 TCTGGAACATCGTATGGGTATCCTCCAGCGGCCGACAGCTTTTTGGCACAGTCA
424 GGGCAATACACCGCTC-3', and cloned into pLVX-IRES-ZsGreen1 vector. C-terminal
425 HA-tagged FHL2 coding sequence was synthesized by Genscript and subcloned into
426 pLVX-IRES-ZsGreen1 vector. The plasmids pCI-neo-3×FLAG plasmids expressing
427 the CHIKV nsP3 and nsP4, the Sindbis virus (SINV) and Semliki Forest virus (SFV)
428 nsP3 proteins were previously described⁴¹. The CHIKV nsP3 Δ HVD, Δ R1 to Δ R4 were
429 generated by site-directed mutagenesis (QuickChange XL Site-Directed Mutagenesis
430 Kit, Agilent) using the following sets of primers: Δ HVD-Fwd (5'-
431 CGTAAGTCCAAGGGAATATTGATGATCTTCCCAGGAGTCTGC-3') and Δ HVD-Rev
432 (5'-GCAGACTCCTGGGAAGATCATCAATATTCCCTTGGACTTACG-3'); Δ R1-F: (5'-
433 GTACCTGTGCGCGCCGCCAGAGAGCTGTGTCCGGTCGTACAAGA
434 AAC-3') and Δ R1-R: (5'-GTTTCTTGTACGACCGGACACAGCTCTCTGGGCGGCG
435 CGACAGGTAC-3'); Δ R2-F: (5'-GAAACAGCGGAGACGCGTGACAGTACCGCCA
436 CGGAACCGAATC-3') and Δ R2-R: (5'-GATTCGGTTCGGTGGCGGTTACTGTCACGC
437 GTCTCCGCTGTTTC-3'); Δ R3-F: (5'-CTTCTTACCAGGAGAAGTGTGATGACTTGA
438 CAGACAGC-3') and Δ R3-R: (5'-GCTGTCTGTCAAGTCATCACACTTCTCCTGGTAA
439 GAAG-3'); Δ R4-F (5'-GACGAGAGAGAAGGGAATATAACACCGAGTACCGCCACG
440 GAACCGAATC-3') and Δ R4-R (5'-GATTCGGTTCGGTGGCGGTTACTCGGTGTTATA
441 TTCCCTTCTCTCTCGTC-3').

442 The plasmids expressing the chimeric nsP3 CHIKV-HVD SINV and nsP3 SINV-HVD
443 CHIKV were obtained as follows. First, the DNA sequence coding for the N-terminal
444 parts of the CHIKV or SINV nsP3 (MD-AUD region) are obtained by PCR using the
445 pCI-neo-3×FLAG expression plasmids as templates and the following sets of primers:
446 3xFLAG_NotI-F (5'-ACTGAGCGGCCGCATGGACTACAAAGACCATGAC-3') and
447 Overlap-CHIKV-SINV-R (5'-GCTGTTCTGGCACTTCTATATATTCCTTGGGA
448 CTTACG-3'), or 3xFLAG_NotI-F and Overlap-SINV-CHIKV-R (5'-
449 CAGACTCCTGGGAAGATCTGTACTTACGGGCGGGAAC-3') for CHIKV and SINV
450 constructs, respectively. HVD coding sequences were also generated by PCR using
451 the following primers: Overlap-CHIKV-SINV-F (5'-
452 CGTAAGTCCAAGGGAATATATAGAAGTGCCAGAACAGC-3') and nsP3-
453 SINV_BamHI-R (5'-ACTGAGGATCCTTAGTATTCAGTCCTCCTGCTC-3') for SINV
454 HVD, and Overlap-SINV-CHIKV-F (5'-GTTCCCGCCCGTAAGTACAGATCTTCCCA
455 GGAGTCTG-3') and nsP3-CHIKV_BamHI-R (5'-ACTGAGGATCCTCATAACTCGT
456 CGTCCGTG-3') for CHIKV HVD. Next, the CHIKV-HVD-SINV and SINV-HVD-CHIKV
457 PCR-fragments were obtained by overlap extension PCR using the previously
458 obtained PCR-products and the following sets of primers: 3XFLAG_NotI-F and nsP3-
459 SINV_BamHI-R or nsP3-CHIKV_BamHI-R. Finally, the chimeric PCR fragments were
460 cloned into a NotI-BamHI digested pLVX-IRES-ZsGreen1 vector (Takara).

461 The plasmid expressing FHL1A-R4 and FHL1A-R4* fusion proteins were obtained by
462 overlap extension PCR approach as well. First, the FHL1A part which is common to
463 both constructs was amplified from a cDNA template (Genscript, NM_001449.4) using
464 the common FHL1 Fwd primer (5'-
465 CCGGAGAATTCGCCGCCATGGCGGAGAAGTTTGACTGCCACTACTGC-3') and
466 the Overlap-FHL1A-Fusion Rev primer (5'- CGCCCTGGAAGTACAGGTTCTCGCCG

467 CCGCCCAGCTTTTTGGCACAGTCGGGACAATAC-3'). Second, nsP3-R4 and -R4*
468 portions were obtained by PCR using either the pCI-neo-3×FLAG-nsP3 expression
469 plasmid or the pCHIKV-SG45-R4* plasmid (containing the randomized R4 region) as
470 templates and the following set of primers: Overlap-FHL1-fusion-Fwd (5'-
471 CGAGAACCTGTACTTCCAGGGCGGCGGCGGCCCCATGGCTAGCGTCCGATTCT
472 TTAG-3') and FHL1-fusion-Rev (5'-AATAGTTTAGCGGCCGCTCAAGCGTAATCT
473 GGAACATCGTATGGGTAGCCGCCGCCGGTGGTGCCTGAAGAGACATTGCTG-
474 3') for R4 construct, or FHL1-fusion-Rand-Rev primer (5'-
475 AATAGTTTAGCGGCCGCTCAAGCGTAATCTGGAACATCGTATGGGTAGCCGCC
476 GCCCCTCACCTCGGCGCACATGG-3') for the randomized R4* construct. Next, the
477 FHL1A-R4 and FHL1A-R4* PCR-fragments were obtained by PCR using the
478 previously obtained PCR-products and the outer sets of primers: FHL1A Fwd and
479 FHL1-fusion-Rev or FHL1-fusion-Rand-Rev. Amplification fragments were cloned into
480 a NotI-EcoRI digested pLVX-IRES-ZsGreen1 vector (Takara).

481 To obtain pCHIKV-M-Gluc a viral sequence encompassing the CHIKV 26S promoter
482 and a part of the capsid protein sequence was amplified from pCHIKV-M using primers
483 5'-TATGCGTTTAAACCATGGCCACCTTTGCAAGCTCCAGATC-3' and 5'-
484 GCTTCTTATTCTTCCGATTCCTGCGTGG-3', cut with PmeI and BssHII and
485 assembled together with an AgeI-PmeI fragment from pCHIKVRepl-Gluc⁴² into an
486 AgeI-BssHII cut vector. From the resulting plasmid the AgeI-BssHII fragment was
487 released and ligated together with a BssHII-SfiI fragment from pCHIKV-M⁴³ into
488 pCHIKV-M cut with AgeI and SfiI.

489 To establish pCHKV-Rluc-GAA two PCR fragments were amplified from pCHIKV-WT
490 using primers CHIKV 5590 F (5'-AGACTTCTTACCAGGAGAAGTG-3') and Bo422 (5'-
491 CGACTCCATGTATTATGTTaccgctgcGATGAAGGCCGCGCACGCGG-3') or Bo421

492 (5'-CCGCGTGCGCGGCCTTCATCgcagcgggtAACATAATACATGGAGTCG-3') and
493 CHIKV 8512 R (5'-GAAGTTGTCCTTGGTGCTGC-3'), respectively. The obtained
494 fragments were fused via PCR amplification using the outer primers CHIKV 5590 F
495 and CHIKV 8512 R. The resulting fragment was cut with AgeI and BglI and inserted
496 into pCHIKV-Rluc cut with the same restriction enzymes.

497 For generation of CHIKV-Rluc- Δ R4 and CHIKV-Rluc-R4* first PCR fragments
498 encompassing the desired changes were amplified and assembled as follows: 1)
499 CHIKV-Rluc- Δ R4: two fragments amplified from CHIKV-Rluc using Bo408 (5'-
500 CACCACGTGCTCCTGGTCAGTG-3') and Bo1259 (5'-
501 gattcgggtccgtggcgggtactcgggtgttatattcccttctctctcgtca-3') or Bo1258 (5'-
502 tgacgagagagaagggaatataacaccgagtaccgccacggaaccgaatc-3') and Bo409 (5'-
503 GACTTCCTCCAGGGTGTTACC-3'), respectively, were fused together using the
504 outer primers Bo408 and Bo409. 2) CHIKV-Rluc-R4*: the randomized sequence
505 cassette was obtained sequentially from three successive PCRs: First PCR fragment
506 was generated using primers Bo1260 (5'-
507 AGCACCGTGCCCCTGCCCGCCCTGAGGAGGGCCAGCTTCGCCGACACCATGG
508 AGCAGACC-3') and Bo1261 (5'-
509 CCTCACCTCGGCGCACATGGGGAACTGCTCGGCCACGGTCTGCTCCATGGTGT
510 CGGCGAA-3'). Then, it was fused at the 5' end with a PCR fragment amplified from
511 CHIKV-Rluc with Bo408 and Bo1262 (5'-
512 TCAGGGCGGGCAGGGGCACGGTGCTgttatattcccttctctcgtca-3'). Next, the
513 resulting fragment is further fused at the 3' end with a PCR fragment amplified from
514 CHIKV-Rluc with Bo1263 (5'-
515 GTTCCCATGTGCGCCGAGGTGAGGccgagtaccgccacggaaccgaatc-3') and Bo409,
516 using the outer primers Bo408 and Bo409. Finally, the PCR fragments containing the

517 Δ R4 and R4* mutations were cut with SacII and AgeI and fused in each case with a
518 NgoMIV-SacII fragment derived from CHIKV-Rluc (SG45) and were cloned into a
519 NgoMIV-AgeI digested SG45 plasmid.

520

521 **Trans-complementation and over expression experiments.** The lentiviral plasmids
522 containing FHL1 isoforms were packaged as described above (see 'CRISPR genetic
523 screen' section). Cells of interest were stably transduced by spinoculation (750 x g for
524 2 hours at 32°C) with these lentiviruses and, when necessary, sorted for GFP-positive
525 cells by flow cytometry. For trans-complementation assays cells were inoculated with
526 CHIKV21 for 48 hours. Cells were then collected and processed for E2 expression by
527 flow cytometry. For ectopic expression, cells were plated on 24-well plates (5×10^4) and
528 incubated with CHIKV-M-GLuc and CHIKV21, and either processed for E2 expression
529 by flow cytometry or infectious virus yield quantification on Vero E6 cells.

530

531 **Kinetic of infection by qPCR assay.** Control and Δ FHL1 HAP1 cells were plated on
532 60 mm dishes (400,000 cells) and inoculated with CHIKV21 (MOI of 5). At indicated
533 time point cells were washed thrice with PBS, incubated with trypsin 0.25% for 5 min
534 at 37°C to remove cells surface bound particles, and total RNA was extracted using
535 the RNeasy plus mini kit (Qiagen) according to manufacturer's instruction. cDNAs were
536 generated from 500 ng total RNA by using the Maxima First Strand Synthesis Kit
537 following manufacturer's instruction (Thermo Fisher Scientific). Amplification products
538 were incubated with 1 Unit of RNase H for 20 min at 37 °C, followed by 10 min at 72°C
539 for enzyme inactivation, and diluted 10-fold in DNase/RNase free water. Real time
540 quantitative PCR was performed using a Power Syber green PCR master Mix (Fisher
541 Thermo Scientific) on a Light Cycler 480 (Roche). The primers used for qPCR were:

542 E1-C21_F (5'-ACGCAGTTGAGCGAAGCAC-3'), E1-C21_R (5'-CTGAAGACATTG
543 GCCCCAC-3') for viral RNA quantification, and Quantitect primers for GAPDH were
544 purchased from Qiagen. The relative expression quantification was performed based
545 on the comparative threshold cycle (C_T) method, using GAPDH as endogenous
546 reference control. CHIKV negative strand RNA was quantified as previously
547 described⁴⁴. Briefly, cDNA were generated from 1 μ g total RNA using a primer
548 containing a 5' tag sequence CHIKV(-)Tag (5'-
549 GGCAGTATCGTGAATTCGATGCCGCTGTACCGTCCCCATTCC-3') and the
550 SuperScript II reverse transcriptase following the manufacturer's instruction (Thermo
551 Fisher Scientific). Amplifications products were diluted 10-fold and used for real time
552 quantitative PCR with the following primers CHIKV(-)fwd (5'-
553 GGCAGTATCGTGAATTCGATGC-3') and CHIKV(-)rev (5'-ACTGCTGAGTCCAAAG
554 TGGG-3'). The 133 bp sequence corresponding to the amplified cDNA was
555 synthesized by Genescript and serially diluted (650 to 6.5x10⁹ genes copies/ μ l) to
556 generate standard curves.

557

558 **Genomic viral RNA transfection and kinetic of viral amplification.** To assess
559 CHIKV RNA replication within the cells, we transfected control and Δ FHL1 cells with
560 capped genomic viral RNA generated from pCHIKV-M-Gluc (see 'Virus strains and
561 culture' section). Cells were plated on 48 well plate (3x10⁴ cells) and transfected with
562 100 ng of purified RNA using the Lipofectamine MessengerMax reagent according to
563 the manufacturer's instruction (Thermo Fisher Science), and cells were cultured in
564 absence or presence of 15 mM NH₄Cl to prevent subsequent viral propagation. At
565 specific times, cells were washed once with PBS and lyzed with Gaussia lysis buffer.
566 Lysates were kept at -20°C until all samples were collected. Luciferase activity was

567 measured by using the Pierce Gaussia Luciferase Glow assay kit on a TriStar2 LB 942
568 with 20 µl of cell lysate, 20 µl of substrate and 2s integration time.

569 The same experimental approach was used to monitor luciferase activity from capped
570 genomic viral RNA generated from pCHIKV-Rluc WT (SG45), pCHIKV-Rluc-GAA,
571 pCHIKV-Rluc-ΔR4 and pCHIKV-Rluc-R4* mutants. Luciferase activity was measured
572 using the Renilla Luciferase assay system (Promega) on a TriStar2 LB 942 with 20 µl
573 of cell lysate, 20 µl of substrate and 2.5s integration time.

574

575 **Immunoblot.** Cell pellet were lysed in Pierce™ IP Lysis Buffer (Thermo Fisher
576 Scientific) containing Halt™ Protease and Phosphatase Inhibitor Cocktail (Thermo
577 Fischer Scientific) for 30 min at 4°C. Equal amount of protein, determined by
578 DC™ Protein Assay (BioRad), were prepared in LDS Sample Buffer 4X (Pierce™)
579 containing 25 mM dithiothreitol (DTT) and heated at 95°C for 5 min. Samples were
580 separated on Bolt™ 4-12% Bis-Tris gels in Bolt® MOPS SDS Running Buffer (Thermo
581 Scientific), and proteins were transferred onto a PVDF membrane (BioRad) using the
582 Power Blotter system (Thermo Fischer Scientific). Membranes were blocked with PBS
583 containing 0.1% Tween-20 and 5% non-fat dry milk and incubated overnight at 4°C
584 with primary antibody. Staining was revealed with corresponding horseradish
585 peroxidase (HRP)-coupled secondary antibodies and developed using SuperSignal™
586 West Dura Extended Duration Substrate (Thermo Fisher Scientific) following
587 manufacturer's instructions. The signals were acquired through Fusion Fx camera
588 (VILBERT Lourmat).

589

590 **Co-immunoprecipitation assay.** HEK-293T cells were plated in 10 cm dishes (5.10⁶
591 cells/ dish). Twenty-four hours later, the cells were transfected with a total of 15 µg of

592 DNA expression plasmids (7.5 µg of each plasmid in co-transfection assays). Twenty-
593 four hours post-transfection the cells washed once with PBS and collected with a cell
594 scrapper. After 5 min centrifugation (400 x g for 5 min), cells pellets were lysed for 30
595 min in cold IP lysis buffer supplemented with Halt™ Protease and Phosphatase
596 Inhibitor Cocktail, and then cleared by centrifugation for 15 min at 6,000 x g.
597 Supernatants were incubated overnight at 4°C, with either anti-FLAG magnetic beads
598 or HA magnetic beads (see 'reagent' section above). Beads were washed three times
599 with BO15 buffer (20 mM Tris-HCl pH 7.4, 150 mM NaCl, 5 mM MgCl₂, 10% Glycerol,
600 0.5 mM EDTA, 0.05% Triton, 0.1% Tween-20). The retained complexes were eluted
601 twice with either 3xFLAG-peptide (200 µg/ml; SIGMA F4799-4MG) or HA peptide (400
602 µg/ml; Roche# 11666975001) for 30 min at room temperature. Samples were prepared
603 and subjected to immunoblot as described above. For input, 1% of whole cell lysate
604 were loaded on the gel.

605

606 **Bacterial expression, purification and GST pull down assay.** To express nsP3,
607 nsP3ΔHVD as glutathione S-transferase fusion proteins, their respective open reading
608 frame (orf) were subcloned into pGEX-4T-1. Similarly, FHL1A cDNA was subcloned
609 into the pET47b (+) and expressed as a 6xHis fusion protein. The following
610 oligonucleotides were used to amplify nsP3 and nsP3ΔHVD cDNAs (sense: 5'-
611 ccccggaattcATGgcaccgctgtaccgggtaa-3'; antisense: 5'-
612 ccgctcgagTCAtaactcgtcgtccgtgtctg-3') and FHL1A (sense: 5'-
613 ccggaattccATGgcggagaagtttgactgcc-3'; antisense: 5'-
614 ccgctcgagTTAcagcttttggcacagtc-3'). E.Coli strain BL21 Star (Invitrogen) was
615 transformed with recombinant expression vectors encoding GST-nsP3, GST-
616 nsP3ΔHVD or 6xHis-FHL1A recombinant proteins. Transformed bacteria were

617 induced with isopropylthio- β -Dgalactoside (IPTG) for 3 hours at 37°C. Cells were
618 collected by centrifugation and the pellets were resuspended in lysis buffer containing
619 lysozyme (1 mg/mL), incubated 30 min at 4°C followed by three subsequent freeze-
620 thawed cycles and sonication. The bacterial lysates were centrifuged at 13,000 r.p.m
621 for 20 min and the supernatants were incubated with glutathione-Sepharose beads for
622 GST-nsP3 and GST-nsP3 Δ HVD, or Ni-NTA column (Qiagen) for 6xHis-FHL1A.
623 Column washing and recombinant protein elution were performed according to the
624 manufacturer's instructions. Five μ L of eluted GST fusion proteins and 3 μ L of Ni-NTA
625 eluted 6xHis-FHL1A were analyzed by SDS-PAGE and proteins were visualized by
626 Coomassie staining. For pull-down assay, GST, GST-nsP3 or GST-nsP3 Δ HVD bound
627 beads were incubated with 6xHis-FHL1A for 1 hour at 4°C in presence of 100 μ M
628 ZnSO₄. The resin was washed extensively with a buffer containing 500 mM KCL. The
629 beads were then resuspended in Laemmli buffer, resolved on SDS-PAGE and the
630 presence of 6xHis-FHL1A was assessed by western blot using anti-FHL1 antibody.

631

632 **Genetic analysis, fibroblasts and myoblasts from Emery-Dreifuss muscular**
633 **dystrophy patients.** Dermal fibroblasts and myoblasts were taken from 4 patients
634 carrying *FHL1* gene mutations. *FHL1* gene was analyzed as previously reported ⁶ as
635 they had, among other symptoms, features reminiscent of Emery-Dreifuss muscular
636 dystrophy. Patients P1, P2 and P3 were previously reported ⁶ with detailed clinical
637 description (respectively as patient F321-3, F997-8 and F1328-4) while patient P4 was
638 not yet published. Briefly, patient P4 had myopathy with joint contractures, hypertrophic
639 cardiomyopathy, vocal cords palsy, short stature, alopecia, skin abnormalities and
640 facial dysmorphism. In this patient, *FHL1* analysis revealed an insertion of a full-length
641 LINE-1 retrotransposon sequence together with poly A tail of unknown length (i.e.,?

642 thereafter) after 27 bp of the start of exon 4 (c.183_184ins [LINE1;?; 171_183]) that
643 results at mRNA level in altered splicing with retention of 108 bp of the inserted LINE
644 sequence leading to predicted premature termination codon and shorter FHL1A
645 (Extended Data Fig. 7b).

646

647 **Ethics statement.** All materials (skin and/or muscle biopsies) from patients and
648 controls included in this study were taken with the informed consent of the donors and
649 with approval of the local ethical boards. All the procedures were followed alongside
650 the usual molecular diagnostic procedure during patient follow-up, and in accordance
651 with the ethical standards of the responsible national committee on human
652 experimentation.

653

654 **In vivo studies.** Animals were housed in the Institut Pasteur animal facilities
655 accredited by the French Ministry of Agriculture for performing experiments on live
656 rodents. Work on animals was performed in compliance with French and European
657 regulations on care and protection of laboratory animals (EC Directive 2010/63, French
658 Law 2013-118, February 6th, 2013). All experiments were approved by the Ethics
659 Committee #89 (and registered under the reference APAFIS#6954-
660 2016091410257906 v2). Male mice either deficient for FHL1 (FHL1-null) or not (WT
661 littermates) were obtained by crossing heterozygous females for FHL1⁴⁵ with WT male
662 Black Swiss mice. Nine day-old male littermates, both FHL1-null and WT mice, were
663 injected with CHIKV21 (10⁵ PFU/20µl) by intradermal route and viral load was
664 determined in tissues by day 7 post infection. Virus titers in tissue samples were
665 determined on Vero E6 cells by tissue cytopathic infectious dose 50 (TCID₅₀/g). For
666 histology experiments, muscles were snap frozen in isopentane cooled by liquid

667 nitrogen for cryo-sectioning then processed for histological staining (hematoxylin and
668 eosin) or immunolabelling.

669

670 **Transmission electron microscopy.** Cells were scrapped and fixed for 24 h in 1%
671 glutaraldehyde, 4% paraformaldehyde, (Sigma, St-Louis, MO) in 0.1 M phosphate
672 buffer (pH 7.2). Samples were then washed in phosphate-buffered saline (PBS) and
673 post-fixed for 1 h by incubation with 2% osmium tetroxide (Agar Scientific, Stansted,
674 UK). Cells were then fully dehydrated in a graded series of ethanol solutions and
675 propylene oxide. Impregnation step was performed with a mixture of (1:1) propylene
676 oxide/Epon resin (Sigma) and then left overnight in pure resin. Samples were then
677 embedded in Epon resin (Sigma), which was allowed to polymerize for 48 hours at
678 60°C. Ultra-thin sections (90 nm) of these blocks were obtained with a Leica EM UC7
679 ultramicrotome (Wetzlar, Germany). Sections were stained with 2% uranyl acetate
680 (Agar Scientific), 5% lead citrate (Sigma) and observations were made with a
681 transmission electron microscope (JEOL 1011, Tokyo, Japan).

682

683 **Cell viability assay.** Cell viability and proliferation were assessed using the CellTiter-
684 Glo 2.0 Assay (Promega) according to the manufacturer's protocol. In brief, cells were
685 plated in 48-well plates (3×10^4). At specific times, 100 μ l of CellTiter-Glo reagent were
686 added to each well. After 10 min incubation, 200 μ l from each well were transferred to
687 an opaque 96-well plate (Cellstar, Greiner bio-one) and luminescence was measured
688 on a TriStar2 LB 942 (Berthold) with 0.1 second integration time.

689

690 **Statistical analysis.** Graphical representation and statistical analyses were performed
691 using Prism7 software (GraphPad Software). Unless otherwise stated, results are

692 shown as means +/- standard deviation (SD) from at least 2 independent experiments
693 in duplicates. Differences were tested for statistical significance using the unpaired
694 two-tailed *t* test, One-way or Two-way Anova with multiple comparison post-test.
695

- 697 1. Burt, F. J. *et al.* Chikungunya virus: an update on the biology and pathogenesis of this
698 emerging pathogen. *Lancet Infect. Dis.* **17**, e107–e117 (2017).
- 699 2. Silva, L. A. & Dermody, T. S. Chikungunya virus: epidemiology, replication, disease
700 mechanisms, and prospective intervention strategies. *J. Clin. Invest.* **127**, 737–749 (2017).
- 701 3. Weaver, S. C., Charlier, C., Vasilakis, N. & Lecuit, M. Zika, Chikungunya, and Other
702 Emerging Vector-Borne Viral Diseases. *Annu. Rev. Med.* **69**, 395–408 (2018).
- 703 4. Greene, W. K., Baker, E., Rabbitts, T. H. & Kees, U. R. Genomic structure, tissue
704 expression and chromosomal location of the LIM-only gene, SLIM1. *Gene* **232**, 203–207
705 (1999).
- 706 5. Schessl, J., Feldkirchner, S., Kubny, C. & Schoser, B. Reducing body myopathy and
707 other FHL1-related muscular disorders. *Semin. Pediatr. Neurol.* **18**, 257–263 (2011).
- 708 6. Gueneau, L. *et al.* Mutations of the FHL1 gene cause Emery-Dreifuss muscular
709 dystrophy. *Am. J. Hum. Genet.* **85**, 338–353 (2009).
- 710 7. Ooi, Y. S., Stiles, K. M., Liu, C. Y., Taylor, G. M. & Kielian, M. Genome-wide RNAi
711 screen identifies novel host proteins required for alphavirus entry. *PLoS Pathog.* **9**, e1003835
712 (2013).
- 713 8. Karlas, A. *et al.* A human genome-wide loss-of-function screen identifies effective
714 chikungunya antiviral drugs. *Nat. Commun.* **7**, 11320 (2016).
- 715 9. Zhang, R. *et al.* Mxra8 is a receptor for multiple arthritogenic alphaviruses. *Nature*
716 **557**, 570–574 (2018).
- 717 10. Tanaka, A. *et al.* Genome-Wide Screening Uncovers the Significance of N-Sulfation
718 of Heparan Sulfate as a Host Cell Factor for Chikungunya Virus Infection. *J. Virol.* **91**, 1_22
719 (2017).
- 720 11. Shalem, O. *et al.* Genome-scale CRISPR-Cas9 knockout screening in human cells.
721 *Science* **343**, 84–87 (2014).
- 722 12. Schuffenecker, I. *et al.* Genome microevolution of chikungunya viruses causing the
723 Indian Ocean outbreak. *PLoS Med.* **3**, e263 (2006).
- 724 13. Li, W. *et al.* MAGeCK enables robust identification of essential genes from genome-
725 scale CRISPR/Cas9 knockout screens. *Genome Biol.* **15**, 554 (2014).
- 726 14. Shathasivam, T., Kislinger, T. & Gramolini, A. O. Genes, proteins and complexes: the
727 multifaceted nature of FHL family proteins in diverse tissues. *J. Cell. Mol. Med.* **14**, 2702–
728 2720 (2010).
- 729 15. Brown, S. *et al.* Characterization of two isoforms of the skeletal muscle LIM protein
730 1, SLIM1. Localization of SLIM1 at focal adhesions and the isoform slimmer in the nucleus
731 of myoblasts and cytoplasm of myotubes suggests distinct roles in the cytoskeleton and in
732 nuclear-cytoplasmic communication. *J. Biol. Chem.* **274**, 27083–27091 (1999).
- 733 16. Krempler, A., Kollers, S., Fries, R. & Brenig, B. Isolation and characterization of a
734 new FHL1 variant (FHL1C) from porcine skeletal muscle. *Cytogenet. Cell Genet.* **90**, 106–
735 114 (2000).
- 736 17. Pen, A. E. *et al.* A novel single nucleotide splice site mutation in FHL1 confirms an
737 Emery-Dreifuss plus phenotype with pulmonary artery hypoplasia and facial dysmorphism.
738 *Eur. J. Med. Genet.* **58**, 222–229 (2015).
- 739 18. Chan, K. K. *et al.* Molecular cloning and characterization of FHL2, a novel LIM
740 domain protein preferentially expressed in human heart. *Gene* **210**, 345–350 (1998).
- 741 19. Rezza, G., Chen, R. & Weaver, S. C. O'nyong-nyong fever: a neglected mosquito-
742 borne viral disease. *Pathog. Glob. Health* **111**, 271–275 (2017).
- 743 20. Couderc, T. *et al.* A mouse model for Chikungunya: young age and inefficient type-I
744 interferon signaling are risk factors for severe disease. *PLoS Pathog.* **4**, e29 (2008).

- 745 21. Roberts, G. C. *et al.* Evaluation of a range of mammalian and mosquito cell lines for
746 use in Chikungunya virus research. *Sci. Rep.* **7**, 14641 (2017).
- 747 22. Scholte, F. E. M. *et al.* Stress granule components G3BP1 and G3BP2 play a proviral
748 role early in Chikungunya virus replication. *J. Virol.* **89**, 4457–4469 (2015).
- 749 23. Kim, D. Y. *et al.* New World and Old World Alphaviruses Have Evolved to Exploit
750 Different Components of Stress Granules, FXR and G3BP Proteins, for Assembly of Viral
751 Replication Complexes. *PLoS Pathog.* **12**, e1005810 (2016).
- 752 24. Jose, J., Taylor, A. B. & Kuhn, R. J. Spatial and Temporal Analysis of Alphavirus
753 Replication and Assembly in Mammalian and Mosquito Cells. *mBio* **8**, 1–16 (2017).
- 754 25. Götte, B., Liu, L. & McInerney, G. M. The Enigmatic Alphavirus Non-Structural
755 Protein 3 (nsP3) Revealing Its Secrets at Last. *Viruses* **10**, 1–26 (2018).
- 756 26. Meshram, C. D. *et al.* Multiple Host Factors Interact with Hypervariable Domain of
757 Chikungunya Virus nsP3 and Determine Viral Replication in Cell-Specific Mode. *J. Virol.*
758 (2018). doi:10.1128/JVI.00838-18
- 759 27. Mutso, M. *et al.* Mutation of CD2AP and SH3KBP1 Binding Motif in Alphavirus
760 nsP3 Hypervariable Domain Results in Attenuated Virus. *Viruses* **10**, (2018).
- 761 28. Schessl, J. *et al.* Proteomic identification of FHL1 as the protein mutated in human
762 reducing body myopathy. *J. Clin. Invest.* **118**, 904–912 (2008).
- 763 29. Bonne, G., Leturcq, F. & Ben Yaou, R. Emery-Dreifuss Muscular Dystrophy. in
764 *GeneReviews*® (eds. Adam, M. P. *et al.*) (University of Washington, Seattle, 1993).
- 765 30. Frolov, I., Kim, D. Y., Akhrymuk, M., Mobley, J. A. & Frolova, E. I. Hypervariable
766 Domain of Eastern Equine Encephalitis Virus nsP3 Redundantly Utilizes Multiple Cellular
767 Proteins for Replication Complex Assembly. *J. Virol.* **91**, (2017).
- 768 31. Uversky, V. N. Intrinsically disordered proteins in overcrowded milieu: Membrane-
769 less organelles, phase separation, and intrinsic disorder. *Curr. Opin. Struct. Biol.* **44**, 18–30
770 (2017).
- 771 32. Nikolic, J. *et al.* Negri bodies are viral factories with properties of liquid organelles.
772 *Nat. Commun.* **8**, 58 (2017).
- 773 33. Fros, J. J. *et al.* Chikungunya Virus nsP3 Blocks Stress Granule Assembly by
774 Recruitment of G3BP into Cytoplasmic Foci. *J. Virol.* **86**, 10873–10879 (2012).
- 775 34. Remenyi, R. *et al.* Persistent Replication of a Chikungunya Virus Replicon in Human
776 Cells Is Associated with Presence of Stable Cytoplasmic Granules Containing Nonstructural
777 Protein 3. *J. Virol.* **92**, (2018).
- 778 35. Kadrmas, J. L. & Beckerle, M. C. The LIM domain: from the cytoskeleton to the
779 nucleus. *Nat. Rev. Mol. Cell Biol.* **5**, 920–931 (2004).
- 780 36. Sheikh, F. *et al.* An FHL1-containing complex within the cardiomyocyte sarcomere
781 mediates hypertrophic biomechanical stress responses in mice. *J. Clin. Invest.* **118**, 3870–
782 3880 (2008).
- 783 37. Raskin, A. *et al.* A novel mechanism involving four-and-a-half LIM domain protein-1
784 and extracellular signal-regulated kinase-2 regulates titin phosphorylation and mechanics. *J.*
785 *Biol. Chem.* **287**, 29273–29284 (2012).
- 786 38. Medina, F. *et al.* Dengue virus: isolation, propagation, quantification, and storage.
787 *Curr. Protoc. Microbiol.* **Chapter 15**, Unit 15D.2. (2012).
- 788 39. Meertens, L. *et al.* The TIM and TAM families of phosphatidylinositol receptors
789 mediate dengue virus entry. *Cell Host Microbe* **12**, 544–557 (2012).
- 790 40. Joung, J. *et al.* Genome-scale CRISPR-Cas9 knockout and transcriptional activation
791 screening. *Nat. Protoc.* **12**, 828–863 (2017).
- 792 41. Pellet, J. *et al.* ViralORFeome: an integrated database to generate a versatile collection
793 of viral ORFs. *Nucleic Acids Res.* **38**, D371–378 (2010).
- 794 42. Gläsker, S. *et al.* Virus replicon particle based Chikungunya virus neutralization assay

795 using Gaussia luciferase as readout. *Viol. J.* **10**, 235 (2013).
796 43. Kümmerer, B. M., Grywna, K., Gläsker, S., Wieseler, J. & Drosten, C. Construction of
797 an infectious Chikungunya virus cDNA clone and stable insertion of mCherry reporter genes
798 at two different sites. *J. Gen. Virol.* **93**, 1991–1995 (2012).
799 44. Plaskon, N. E., Adelman, Z. N. & Myles, K. M. Accurate strand-specific
800 quantification of viral RNA. *PloS One* **4**, e7468 (2009).
801 45. Domenighetti, A. A. *et al.* Loss of FHL1 induces an age-dependent skeletal muscle
802 myopathy associated with myofibrillar and intermyofibrillar disorganization in mice. *Hum.*
803 *Mol. Genet.* **23**, 209–225 (2014).
804
805

806 **ACKNOWLEDGMENTS**

807 This study has received funding from the French Government's Investissement
808 d'Avenir program, Laboratoire d'Excellence "Integrative Biology of Emerging Infectious
809 Diseases" (grant n°ANR-10-LABX-62-IBEID), the "Investissements d'Avenir" program
810 ANR-10-IHUB-0002, the ANR-15-CE15-00029 ZIKAHOST, Institut Pasteur, Inserm
811 and European Research Council. Viruses were graciously provided by the Europe and
812 Virus Archive, which has received funding from the European Union's Horizon 2020
813 research and innovation program under grant agreement No 653316. The authors
814 thank Félix Rey, Olivier Schwartz, Nicolas Manel, Yves Gaudin, Jan Hellert, Marie-
815 Laure Chaix, Stéphane Marot, Sylvain Chawki, Antoine Canat, Alessia Zamborlini, and
816 Hugues de Thé for critical readings of the manuscript and helpful discussions. The
817 authors thank Pierre Thouvenot and David Hardy for technical assistance and Ju Chen
818 and Julius Bogomolovas from UC San Diego (CA, USA) for providing FHL1 knockout
819 mice. The authors are grateful to Mike Diamond and Julie Fox (Washington University
820 School of Medecine, Saint Louis, MO, USA) and Frederic Tangy (Institut Pasteur,
821 France) for providing us with the anti-CHIKV 265 mAb and the alphavirus nsP1-4
822 constructs, respectively.

823

824 **AUTHORS' CONTRIBUTIONS**

825 L.M. and A.A. conceived the study. L.M, M.L.H, T.C, V.K, A.B, L.B.M, C.D., M.L and
826 A.A designed the experiments. L.M. performed the CRISPR-Cas9 screening and
827 infection studies with L.B.M. M.L.H characterized the FHL1 and nsP3 interactions and
828 performed the immunoprecipitation and western blot studies with the help of V.K. A.L.
829 validated the FHL1 gRNA and generated the FHL1 knockout cells described in this
830 study. A.B. performed the immunofluorescence microscopy experiments and infection

831 studies. L.M. and E.S.L. analyzed the gRNA sequencing and identified the hits. J.B.G
832 and P.R. performed the EM experiments. C.D. and M.B performed the GST-pull
833 experiments. B.M.K generated the CHIKV molecular clones described in this study and
834 P.O.V provided key CHIKV reagents. L.P and X.L. provided the alphavirus strains and
835 performed infection studies. T.C. and M.L. performed in vivo studies and provided
836 expertise in the design of CHIKV experiments. S.R. performed virus titration assays
837 and mice genotyping. T.G. performed immunofluorescence experiments in mice
838 tissues with T.C. A.T.B, R.B.Y., L.G., R.J.M. and G.B provided myoblasts and
839 fibroblasts from EDMD patients and the description of a new *FHL1* mutation in EDMD
840 disease. L.M and AA wrote the initial manuscript draft, and the other authors
841 contributed to editing into its final form.

842

843 **FIGURE LEGENDS**

844 **Figure 1. FHL1 is important for infection by CHIKV and ONNV**

845 **a**, Results of the CHIKV screen analyzed by MAGeCK. Each circle represents
846 individual gene. Y-axis represents the significance of sgRNA enrichment of genes in
847 the selected population compared to the non-selected control population. X-axis
848 represents a random distribution of the genes. **b**, E2 protein expression in control or
849 Δ FHL1 cells infected with the CHIKV 21 strain (MOI of 10). **c**, Δ FHL1 HAP1 cells were
850 trans-complemented with FHL1A, B or C isoforms, infected with CHIKV 21 strain (MOI
851 of 10) and stained for E2 protein expression at 48hpi. Data shown in **b** and **c** are mean
852 +/- SD (3 experiments, n=6; one-way ANOVA with Dunnett's multiple comparisons
853 test). **d**, Δ FHL1 and control cells were inoculated with CHIKV-Ross (MOI of 10),
854 CHIKV-Brazza (MOI of 10), CHIKV-20235 (MOI of 10), CHIKV-M (M-899) (MOI of 10)
855 or CHIKV-37997 (MOI of 10) and analyzed at 24 (293T) or 48hpi (HAP1) for E2
856 expression. Data shown are mean +/- SD (4 experiments, n=8 excepted for CHIKV-
857 37997 n=4; one-way ANOVA with Tukey's multiple comparisons test). **e-g**, Δ FHL1 and
858 control HAP1 cells were inoculated with O'nyong-nyong virus (ONNV) (MOI of 2),
859 Mayaro virus (MAYV) (MOI of 50), Eastern equine encephalitis virus (EEEV) (MOI of
860 2), Sindbis virus (SINV), Semliki Forest Virus (SFV), Ross River virus (RRV), Western
861 equine encephalitis virus (WEEV), Venezuelan equine encephalitis virus (VEEV),
862 Dengue virus (DENV) (MOI of 0.4) or ZIKA virus (ZIKV) (MOI of 50). **e**, Infection was
863 quantified 48hpi by flow cytometry using the anti-E2 3E4 or 265 CHIKV mAb or the
864 anti-EEEV mAb 1A4B6 (2 experiments, n=4). **f**, Virus growth was assessed at day 4
865 pi using real-time RT-PCR. Serial dilutions of infected supernatants titrated using the
866 TCID50 method were used as quantification standards for RT-PCR. Accordingly,
867 results were expressed for each virus as "molecular equivalents of TCID50". Data

868 shown are representative of two experiments. **g**, DENV or ZIKV infection were
869 assessed by flow cytometry 48hpi using the anti-E protein 4G2 mAb. (3 experiments,
870 n=6). **e-g** Data shown are mean +/- SD and significance was calculated using a one-
871 way ANOVA statistical test with a Tukey's multiple comparisons test. **h**, BeWo and
872 HepG2 cells were transduced with FHL1A or a control vector and challenged with
873 CHIKV21 (MOI of 5) or CHIKV- M-899 (MOI of 2). Infection was quantified two days
874 later by flow cytometry using the 3E4 mAb. Data shown are mean +/- SD (2
875 experiments, n=4 excepted for BeWo cells infected with CHIKV21, 3 experiments, n=6;
876 one-way ANOVA with Tukey's multiple comparisons test). n.s non-significant; *** $p <$
877 0.0001.

878

879 **Figure 2. FHL1 interacts with CHIKV nsP3 and is required for CHIKV RNA**
880 **replication**

881 **a**, Control and Δ FHL1 HAP1 cells were inoculated with CHIKV 21 (MOI of 10). At the
882 indicated time points, cells were treated with trypsin to remove cell surface bound virus
883 and viral RNA was quantified by qRT-PCR. Data shown are mean +/- SD (3
884 experiments, n=9; two-tailed t-test). **b**, Control or Δ FHL1 293T cells were transfected
885 with *in vitro* transcribed CHIKV-M RNA expressing gaussia luciferase (Gluc) and Gluc
886 activity was monitored at the indicated time points. RLU, relative light units. Data
887 shown are mean +/- SEM (3 experiments, n=12; multiple t-tests). **c**, Control or Δ FHL1
888 293T cells were transfected with a replication-deficient mutant CHIKV (CHIKV-GAA)
889 RNA expressing renilla luciferase (RLuc) and luc activity was monitored at the
890 indicated time points. Data shown are mean +/- SEM (3 experiments, n=12; multiple t-
891 tests). **d**, Control or Δ FHL1 293T cells were transfected with a replication-competent
892 (CHIKV-GDD) or a replicon-deficient mutant CHIKV (CHIKV-GAA) capped RNA

893 expressing RLuc . The RLuc activity was monitored as described in c. Data shown are
894 mean \pm SEM (3 experiments, n=12; 2-way ANOVA with Tukey's multiple comparison
895 test). **e**, negative stranded viral RNA quantification by qRT-PCR from samples
896 collected in **(a)**. Data shown are mean \pm SD (2 experiments, n=8; one-way ANOVA
897 with a Tukey's multiple comparisons test). Dashed line represents the experimental
898 background threshold. **f**, Control and Δ FHL1 293T cells were inoculated with CHIKV
899 21 (MOI of 50). (left panel) Representative images of infected cells stained with anti-
900 dsRNA mAb at 6hpi. (right panel) Number of foci per cell was quantified using the Icy
901 software (2 experiments, n=42 cells in control and n=45 cells in Δ FHL1 cells; two-tailed
902 t-test). **g**, Transmission electron microscopy of control and Δ FHL1 HAP1 cells
903 challenged with CHIKV21 (MOI of 100) at 24h post-infection. Left panel shows CPV-II
904 structures containing attached nucleocapsids at their cytoplasmic side (white arrows)
905 as well as viral particles at the cell surface (thin black arrows). Middle panels show
906 replication spherules (arrowheads) together with viral particles (thin black arrows) at
907 the plasma membrane. PM= Plasma membrane. (Bars, 200nm). **h**, Co-
908 immunoprecipitation of endogenous FHL1 and CHIKV nsP3 from cell lysates of 293T
909 cells infected with a CHIKV nsP3-mCherry reporter virus at MOI 5 or 50. **i**, *In vitro* co-
910 immunoprecipitation analyzing the direct interaction between CHIKV-nsP3 and FHL1A
911 through the HVD domain. GST-precipitation of GST-nsP3 or GST-nsP3 Δ HVD and
912 immunoblot analysis of 6xHis-FHL1A. **j**, 293 T were co-transfected with plasmids
913 encoding FHL1A-HA and FLAG-tagged CHIKV nsP3 WT or CHIKV nsP3 Δ HVD or
914 CHIKV lacking the amino acid region 423-454 (Δ R4). Cellular lysates were subject to
915 immunoprecipitation with anti-FLAG beads followed by immunoblot analysis with anti-
916 FLAG or anti-HA mAb. **k**, (left panel) Schematic representation of FHL1A protein in
917 fusion with the nsP3 interacting region (FHL1A-R4) or a similar randomized sequence

918 (FHL1A-R4*). (Right panel) Immunoassay of the interaction between CHIKV nsP3 and
919 FHL1A fusion proteins in 293T cells co-transfected with FLAG-tagged CHIKV nsP3
920 and either a HA-tagged FHL1A, FHL1A-R4 or FHL1A-R4* constructs. Cellular lysates
921 were subject to immunoprecipitation with anti-FLAG followed by immunoblot analysis
922 with anti-FLAG and anti-HA Ab. **I**, Δ FHL1 293T cells were transfected with an empty
923 vector or plasmids encoding FHL1A, FHL1A-R4 or FHL1A-R4*. Cells were incubated
924 with CHIKV21 (MOI of 5) and infection was quantified 24hpi by flow cytometry. Data
925 shown are mean +/- SD (2 experiments, n=4; one-way ANOVA with Dunnett's multiple
926 comparison test). ** P< 0.01 **** P< 0.0001; ns not significant.

927

928 **Figure 3. Primary myoblasts and fibroblasts from FHL1 deficient patients are**
929 **resistant to CHIKV infection.**

930 **a**, FHL1 expression in primary myoblasts and fibroblasts from healthy donors or
931 Emery-Dreifuss muscular dystrophy (EDMD) patients. CM: control myoblasts, PM:
932 patient myoblasts; CF: control fibroblast, PF: patient fibroblasts. **b**, Cells from controls
933 or EDMD patients were inoculated with CHIKV expressing nsP3-mCherry. At 48-hpi,
934 cells were fixed and images were taken on fluorescence microscope. Images are
935 representative of three experiments. **c**, E2 protein expression in primary cells from
936 healthy controls or EDMD patients infected with CHIKV21 (MOI of 2). Data shown are
937 mean +/- SD (2 experiments, n=4 for myoblast; 4 experiments, n=8 for fibroblast; one-
938 way ANOVA with Tukey's multiple comparisons test). **d**, Quantification of viral particles
939 released in supernatant of infected cells collected at 24, 48- and 72-hpi. FIU, flow
940 cytometry infectious units. Data shown are mean +/- SEM (2 experiments, n=4 for
941 myoblast; 3 experiments, n=6 for fibroblast; multiple t-test). **e**, Primary fibroblasts from
942 a control (CF1) or two FHL1 null patients (PF2, PF4) were inoculated with CHIKV-

943 Ross, CHIKV-Brazza, CHIKV-H20235 strains or MAYV (MOI of 2) and analyzed for E2
944 expression. Data shown are mean +/- SD (3 experiments n=6, one-way ANOVA with
945 Dunnett's multiple comparisons test). **f-g** Fibroblasts from control (CF1) or FHL1 null
946 patients (PF2, PF4) were transduced with a lentiviral vector encoding FHL1A or a
947 control vector and then challenged with CHIKV21 (MOI of 2). **f**, Infection was quantified
948 as described in c. Data shown are mean +/- SD (2 experiments, n=4, one-way ANOVA
949 with Tukey's multiple comparisons test). **g**, Supernatants were collected from infected
950 cells at indicated time point and viral titers were measured on VeroE6 cells. Data
951 shown are mean +/- SEM (2 experiments, n=4; two-way ANOVA with Dunnett's
952 multiple comparisons test). *P<0.05; **P<0.01; **** P< 0.0001; ns not significant.

953

954 **Figure 4. FHL1 is a factor of susceptibility to CHIKV infection in mice.**

955 **a**, Viral titers in tissues of nine-day-old mice. WT littermates (n=5) and FHL1-null mice
956 (n=7) were inoculated with 10⁵ PFU of CHIKV via the ID route and sacrificed by 7 days
957 post infection. The amount of infectious virus in tissues was quantified by TCID50. The
958 broken line indicates the detection threshold. **b**, Hematoxylin and eosin staining of
959 transversal section of skeletal muscle in CHIKV-infected mice. **c**, Immunostaining of
960 nuclei, FHL1, vimentin and CHIKV antigens on skeletal muscle of CHIKV-infected
961 mice. ** P<0.01; ns not significant.

962

963

964 **Extended Data Figures**

965 **Extended Data Fig. 1. CRISPR-Cas9 genetic screen identified essential host** 966 **factors of CHIKV infection**

967 **a**, Schematic of CRISPR-Cas9 genome-wide screen in HAP1 haploid cells. **b**, Ranked
968 list of the top 30 genes identified using MAGeCKs algorithm and their corresponding
969 rank in RIGER analysis. **c**, Venn diagram comparing the top 200 hits from our screen
970 and previous CRISPR and haploid screens for CHIKV host factors.

971

972 **Extended Data Fig. 2. Validation of FHL1 gene edition by CRISPR-Cas9**

973 Schematic of the genomic organization of FHL1 (**a**), alternative splicing of the isoforms
974 FHL1A, FHL1B and FHL1C (**b**) and their corresponding proteins (**c**). Initiation and stop
975 codon are indicated in red and relative positions of the sequence targeted by the
976 sgRNA are indicated in blue. **d**, Sanger sequencing of FHL1 in control and Δ FHL1
977 HAP1 cells. **e**, Genomic DNA was used for PCR amplification using primers flanking
978 the sequence targeted by FHL1 sgRNA2. The absence of an amplification product of
979 3.9 kb (black arrow) in HAP1 clone suggests that a large indel is responsible for the
980 absence of FHL1 expression. Asterisk: unspecific PCR products. **f**, Immunoblot of
981 FHL1 in control and Δ FHL1 cells. One representative of three experiments is shown.
982 **e**, Control and Δ FHL1 cells were plated and viability was assessed over a 72 hours
983 period using the CellTiter-Glo assay. Data shown are mean \pm SEM (2 experiments,
984 $n=8$; two-way ANOVA with Dunnett's multiple comparisons test). * $P<0.05$; ns not
985 significant.

986

987

988 **Extended Data Fig. 3. FHL1 is an essential host factor for CHIKV and ONNV**
989 **infection**

990 **a**, Immunofluorescence images of control and Δ FHL1 HAP1 cells inoculated with
991 CHIKV21 (MOI of 10), fixed 48 hpi and stained for E2 expression. **b**,
992 Immunofluorescence images of control and Δ FHL1 HAP1 cells inoculated with CHIKV
993 expressing nsP3-mCherry (MOI of 10) and fixed 48 hpi. **a, b**, Images were taken on
994 fluorescence microscope and are representative of three experiments. **c**, Control and
995 Δ FHL1 HAP1 cells were inoculated with increasing MOI of CHIKV21, and infection was
996 quantified 48hpi by flow cytometry using the anti-E2 3E4 mAb. Data shown are mean
997 +/- SD (3 experiments, n=6; two-way ANOVA with Tukey's multiple comparison test).
998 **d**, Multi-step growth curves with CHIKV 21 strain in control or Δ FHL1 cells. Data shown
999 are mean +/- SEM (2 experiments, n=4; multiple t-tests). **e**, Control and Δ FHL1 HAP1
1000 cells were inoculated with increasing MOI of ONNV or MAYV, and Infection was
1001 quantified 48hpi by flow cytometry using anti-E2 3E4 and 265 mAbs. Data shown are
1002 mean +/- SEM (2 experiments, n=4; two-way ANOVA with Tukey's multiple
1003 comparisons test). **f**, Control and Δ FHL1 HAP1 cells were inoculated with increasing
1004 MOI of DENV or ZIKV, and infection was quantified 48hpi by flow cytometry using the
1005 anti-E 4G2 mAb. Data shown are mean +/- SEM (3 experiments, n=6; two-way ANOVA
1006 with Tukey's multiple comparisons test). * P< 0.05; **** P< 0.0001; ns not significant.

1007

1008

1009 **Extended Data Fig. 4. FHL1A and FHL2 ectopic expression in Δ FHL1 cells**
1010 **restores CHIKV infection**

1011 **a**, Immunoblot of ectopic FHL1 expression in HAP1 cells stably transduced with an
1012 empty vector or FHL1A, FHL1B or FHL1C isoform. **b**, Quantification in the supernatant

1013 of infected HAP1 cells of viral particles released by measuring viral titer on Vero E6
1014 cells. Data shown are representative of 3 experiments, mean +/- SEM. **c**, ΔFHL1 293T
1015 cells transfected with an empty vector or HA-tagged plasmids encoding FHL1A and
1016 FHL2 were subjected to infection with increasing MOI of CHIKV21. Infection was
1017 quantified 24hpi by flow cytometry. Data shown are mean +/- SD (3 experiments, n=6;
1018 two-way ANOVA with Dunnett 's multiple comparison test) **P<0.01; **** P< 0.0001;
1019 ns not significant.

1020

1021 **Extended Data Fig. 5. FHL1A overexpression in BeWo and HepG2 cells enhances**
1022 **CHIKV infection**

1023 **a**, Expression of endogenous FHL1 in HAP1, 293T, BeWo and HepG2. **b**, Immunoblot
1024 of ectopic FHL1 expression in Bewo and HepG2 cells stably transduced with an empty
1025 vector or HA-tagged FHL1A. **c** and **d**, Bewo cells stably transduced with an empty
1026 vector or HA-tagged FHL1A were inoculated with increasing MOI of CHIKV21. **c**,
1027 Infection was quantified 48hpi by flow cytometry using the anti-E2 3E4 mAb. Data
1028 shown are mean +/- SEM (3 experiments, n=6; Two-way ANOVA with Tukey's multiple
1029 comparisons test). **d**, Quantification in the supernatants of infected cells of viral
1030 particles released by measuring viral titer on Vero E6 cells. Data shown are mean +/-
1031 SD (2 experiments, n=4; two-tailed t-test). **e**, HepG2 cells stably transduced with an
1032 empty vector or FHL1A were inoculated with increasing MOI of CHIKV-M-Gluc.
1033 Infection was quantified 48hpi as indicated in c. Data shown are mean +/- SEM (2
1034 experiments, n=4; Two-way ANOVA with Tukey's multiple comparisons test). **
1035 P<0.001; **** P< 0.0001; ns not significant.

1036

1037 **Extended Data Fig. 6. CHIKV nsP3 directly interacts with FHL1A and FHL2**

1038 **a**, Control or Δ FHL1 HAP1 cells were transfected with CHIKV-M-Gluc capped genomic
1039 RNA expressing Gaussia luciferase (Gluc). Gluc activity was monitored at indicated
1040 time point. RLU, relative light units. Data shown are mean +/- SEM (3 experiments,
1041 n=12; multiple t-tests). **b**, Confocal microscopy of the colocalization of CHIKV nsP3
1042 with FHL1 protein in fibroblasts inoculated with CHIKV-nsP3-mCherry (MOI of 2), fixed
1043 48 hpi and stained with anti-FHL1. Images are representative of three experiments. **c**,
1044 Immunoassay of the interaction between CHIKV nsP3 and FHL1 isoforms in 293T cells
1045 transfected with FLAG-tagged CHIKV nsP3 and either an empty vector or plasmids
1046 encoding the three HA-tagged FHL1 isoforms. Cellular lysates were subject to
1047 immunoprecipitation with anti-FLAG followed by immunoblot analysis with anti-FLAG
1048 and anti-HA. **d**, Immunoassay of the interaction between CHIKV nsP3 and FHL2 in
1049 293T cells transfected with FLAG-tagged CHIKV nsP3 and either an empty vector or
1050 plasmids encoding HA-tagged FHL1 and FHL2. Cellular lysates were subject to
1051 immunoprecipitation with anti-FLAG followed by immunoblot analysis with anti-FLAG
1052 and anti-HA. **e**, Endogenous FHL1, G3BP1 or G3BP2 immunoprecipitation from
1053 control and Δ FHL1 293T cells transfected with plasmids encoding FLAG-tagged
1054 CHIKV, Sindbis (SINV) or Semliki forest virus (SFV) nsP3. Cellular lysates were
1055 subject to immunoprecipitation with anti-FLAG followed by immunoblot analysis with
1056 anti-FLAG, anti-FHL1, anti-G3BP1 and anti-G3BP2. **f**, Endogenous FHL1
1057 immunoprecipitation from 293T cells transfected with plasmids encoding FLAG-tagged
1058 full length CHIKV nsP3, CHIKV nsP3 carrying the SINV HVD (CHIKV/HVD-SIV) or
1059 Sindbis nsP3 carrying CHIKV HVD (SINV/HVD-CHIKV). Cellular lysates were
1060 subjected to immunoprecipitation with anti-FLAG followed by immunoblot analysis with
1061 anti-FLAG and anti-FHL1. **g**, Purified GST-tagged nsP3 constructs and HA-tagged

1062 FHL1A detected by coomassie blue staining. **c-i**, One experiment representative of
1063 three is shown. *P<0.05; **P<0.01; **** P< 0.0001; ns not significant.

1064

1065 **Extended Data Fig. 7. Mapping the FHL1–nsP3 interaction**

1066 **a**, The sequence alignment of nsP3 protein HVD domains of representative members
1067 of New and Old World alphaviruses. Sequence alignment was performed with Clustall
1068 Omega and edited with Jalview. R1, R2 and R3 sequences of high homology between
1069 CHIKV strains and ONNV are defined by colored lines. CHIKV06-21 (GenBank
1070 accession number AM258992.1); CHIKV Ross (GenBank accession number
1071 MG280943.1); CHIKV H20235 (GenBank accession number MG208125.1); CHIKV
1072 37997 (GenBank accession number AY726732.1); ONNV (GenBank accession
1073 number MF409176.1); SFV (GenBank accession number HQ848388.1); MAYV
1074 (GenBank accession number KY618137.1); SINV (GenBank accession number
1075 MF409178.1); EEEV (GenBank accession number Q4QXJ8.2); VEEV (GenBank
1076 accession number P27282.2). **b**, (top panel) Schematic representation of CHIKV nsP3
1077 constructs deleted for the R1, R2, R3 or R4 sequences. (bottom panel) 293T cells were
1078 transfected with FHL1A-HA and either an empty vector or plasmids encoding FLAG-
1079 tagged nsP3 constructs. Cell lysates were immunoprecipitated with anti-FLAG
1080 followed by immunoblot analysis with anti-HA or anti-FLAG Ab. One experiment
1081 representative of three is shown. **c**, Alignment of nsP3 regions containing the WT R4
1082 sequence or the corresponding randomized sequence. Dashes represents identical
1083 aa. **d**, Control 293T cells were transfected with the indicated CHIKV capped in vitro
1084 transcribed RNA expressing renilla luciferase (Rluc). Rluc activity was monitored at
1085 indicated time points. RLU, relative light units. Data shown are mean +/- SEM (2

1086 experiments, n=8; Two-way ANOVA with Tukey's multiple comparisons test). **** P<
1087 0.0001; ns not significant.

1088

1089 **Extended Data Fig. 8. CHIKV Infection of myoblasts and fibroblasts derived from**
1090 **EDMD patients**

1091 **a**, Schematic of FHL1A protein in three EDMD patient (P1, P2 and P3). **b**, Schematic
1092 of FHL1 genomic organization in newly described patient with a LINE1 insertion within
1093 exon 4 (P4). **c**, Myoblasts and fibroblasts from EDMD patients or healthy donors were
1094 infected with increasing MOI of CHIKV21, and infection was quantified 24hpi by flow
1095 cytometry using the anti-E2 3E4 mAb. Data shown are mean +/- SEM (2 experiments,
1096 n=4 for myoblast; 3 experiments, n=6 for fibroblast; Two-way ANOVA with Dunnett's
1097 multiple comparisons test). **d**, Fibroblasts from EDMD patients or healthy donors were
1098 inoculated with increasing MOI of CHIKV-Ross, CHIKV-Brazza, CHIKV-H20235, and
1099 infection was quantified 24hpi by flow cytometry using the anti-E2 3E4 mAb. Data
1100 shown are mean +/- SEM (3 experiments, n=6; two-way ANOVA with Dunnett's
1101 multiple comparisons test). **e**, Immunoblot of ectopic FHL1 expression in patient
1102 primary fibroblast (PF2 and PF4) cells stably transduced with an empty vector or a
1103 plasmid encoding HA-FHL1A. One representative of two experiments is shown. ****
1104 P< 0.0001; ns not significant.

1105

1106 **Extended Data Fig.9. Mouse FHL1 interacts with CHIKV nsP3 and restores**
1107 **infection in Δ FHL1 cells**

1108 **a**, Sequence alignment of murine and human FHL1A proteins. **b**, 293T cells were co-
1109 transfected with FLAG-tagged CHIKV nsP3 and plasmids encoding HA-tagged mFHL1
1110 or hFHL1A. Cellular lysates were subject to immunoprecipitation with anti-HA followed

1111 by immunoblot analysis with anti-FLAG (nsP3) and anti-HA (FHL1). **c**, Immunoblot of
1112 FHL1 ectopic expression in Δ FHL1 293T stably transduced with plasmid encoding
1113 murine FHL1 (mFHL1) or human FHL1A (hFHL1A). **d**, Cells showed in **c** were
1114 inoculated with increasing MOI of CHIKV21. Infection was quantified by flow cytometry
1115 at 24 hpi using anti-E2 3E4 mAb. Data shown are mean +/-SD (3 experiments, n=6;
1116 two-way ANOVA with Dunnett's multiple comparisons test). **e**, (left panel) Immunoblot
1117 of endogenous FHL1 in control and Δ FHL1 C2C12 murine cells. (right panel) Control
1118 and Δ FHL1 cells were inoculated with CHIKV21 or MAYV (MOI of 2) and infection was
1119 quantified at 24hpi by flow cytometry using anti-E2 3E4 or anti-E2 265 mAb. One
1120 representative of three experiments is shown. ***P<0.001; ****P<0.0001; ns not
1121 significant.

1122

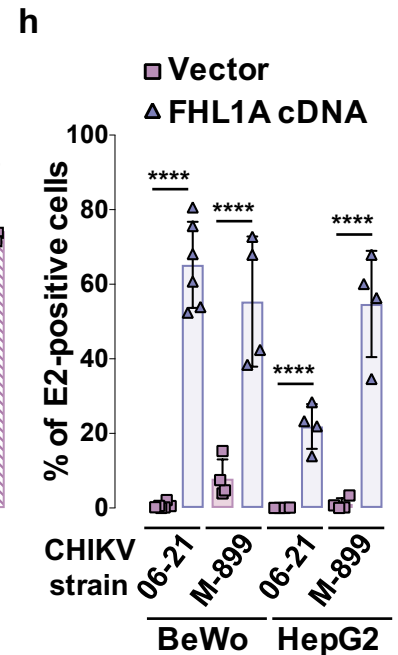
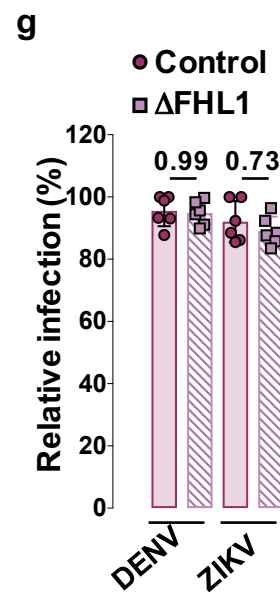
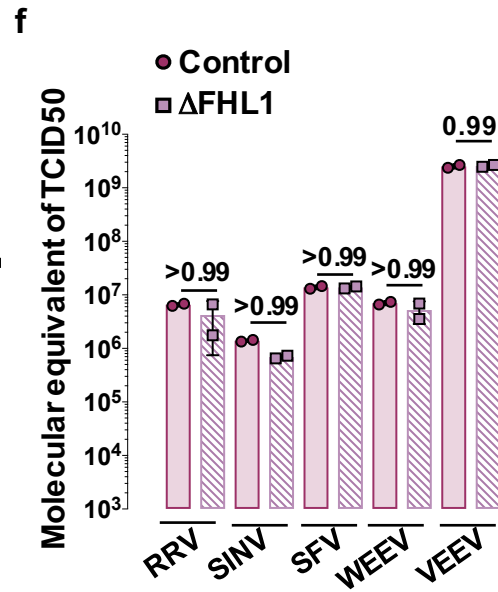
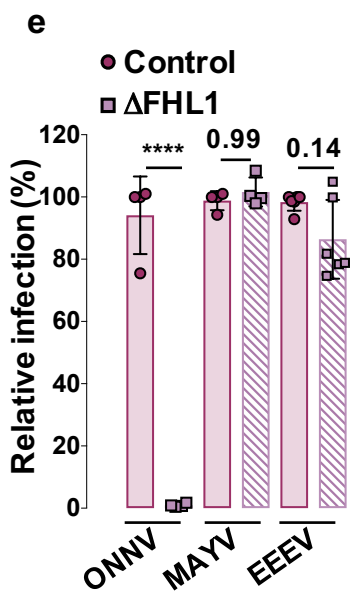
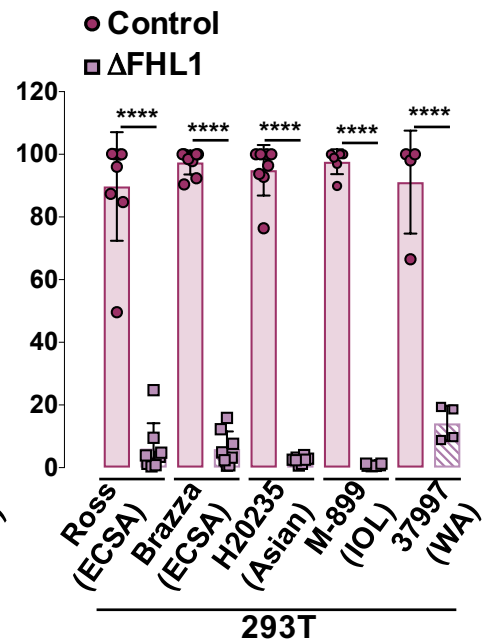
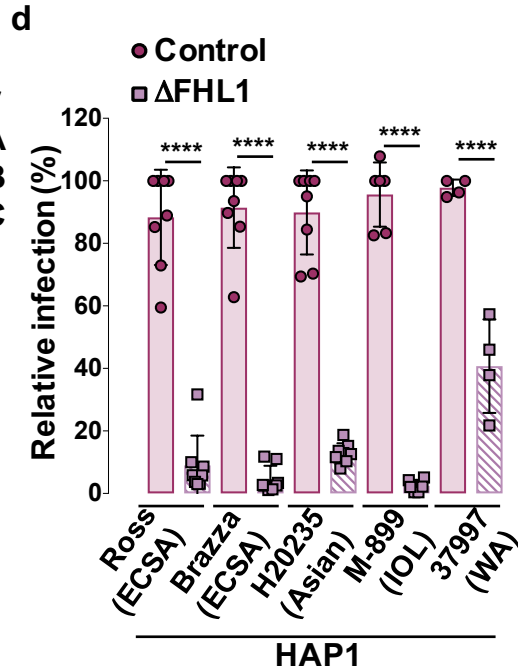
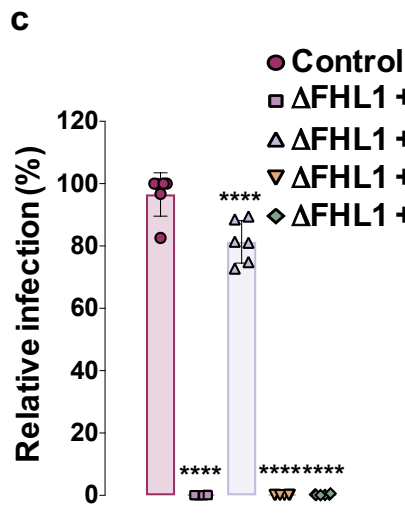
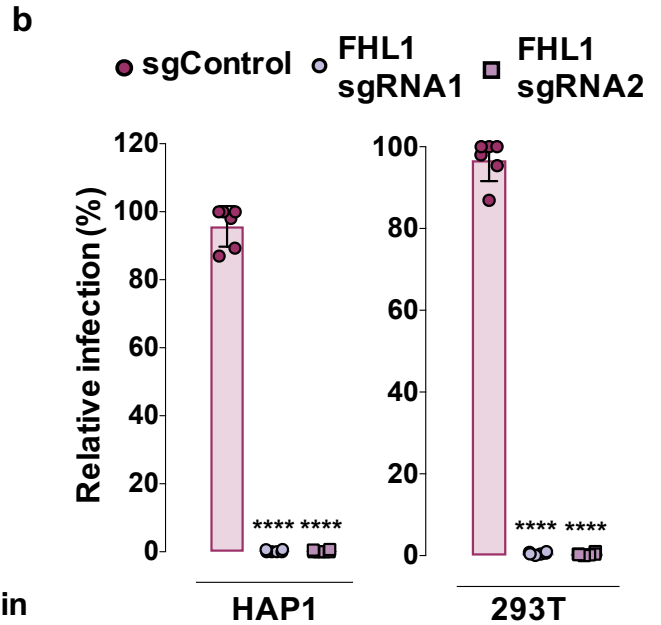
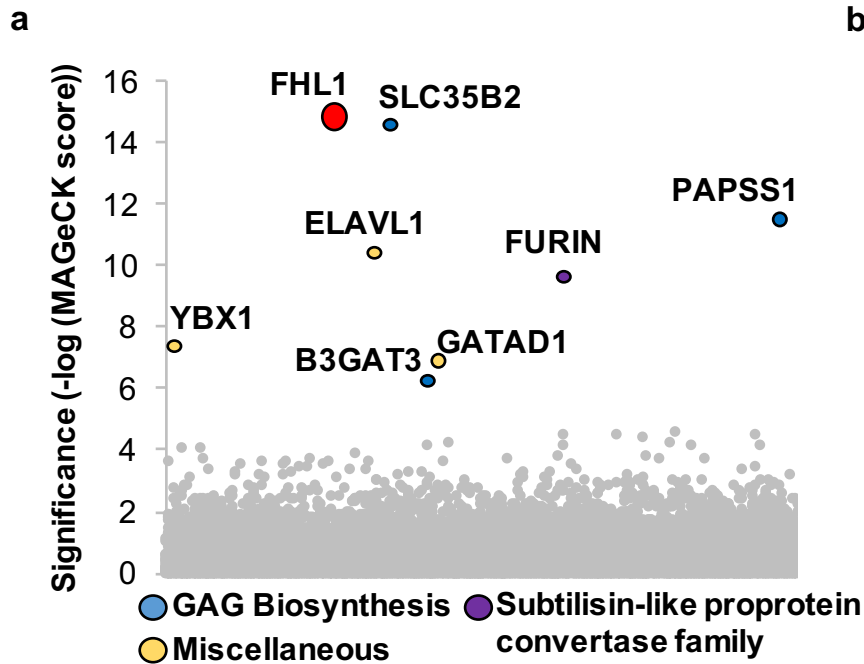

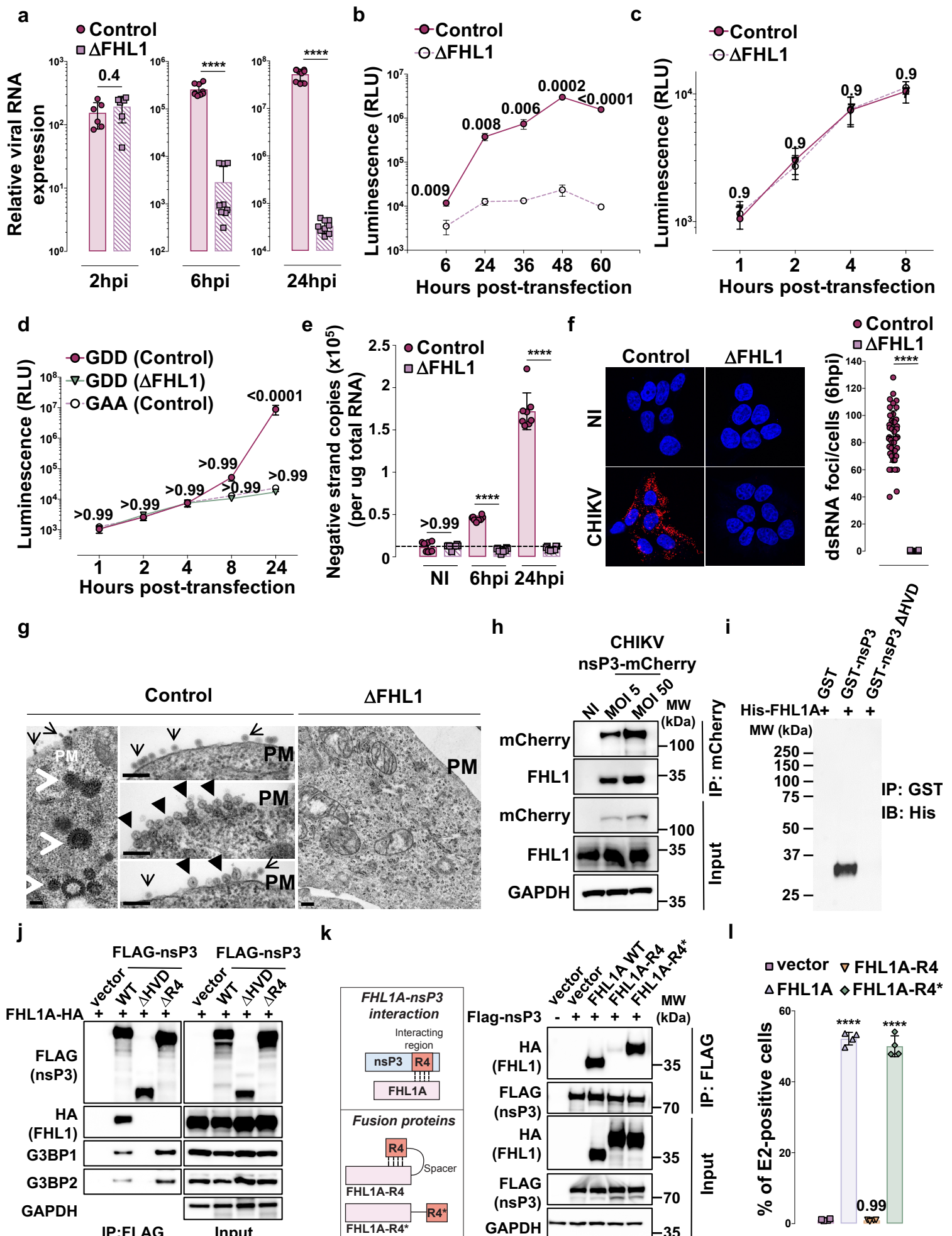

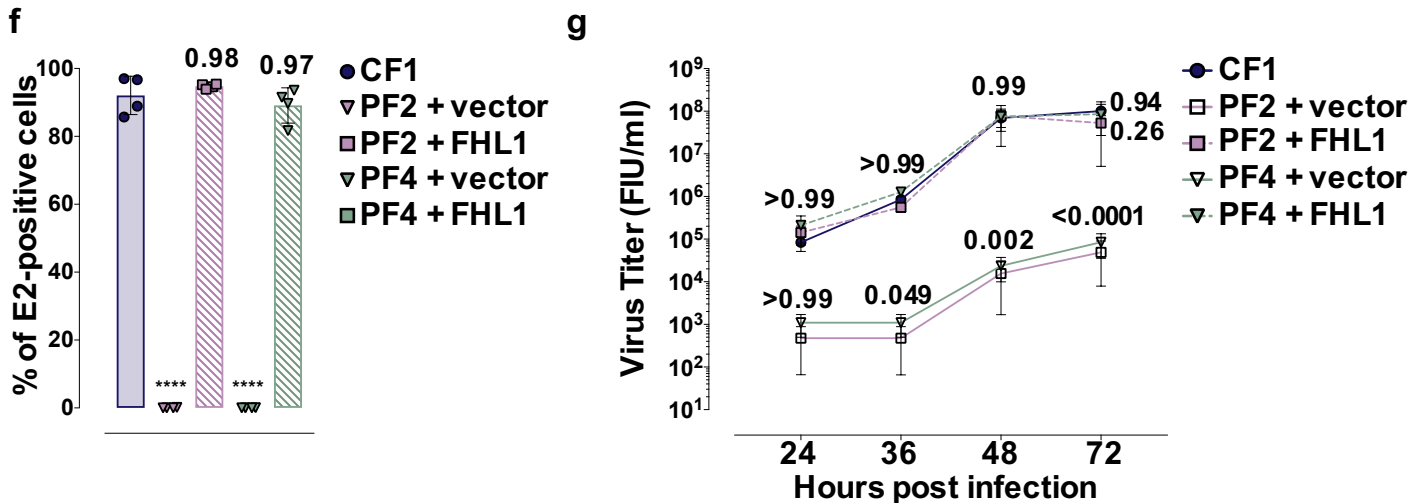
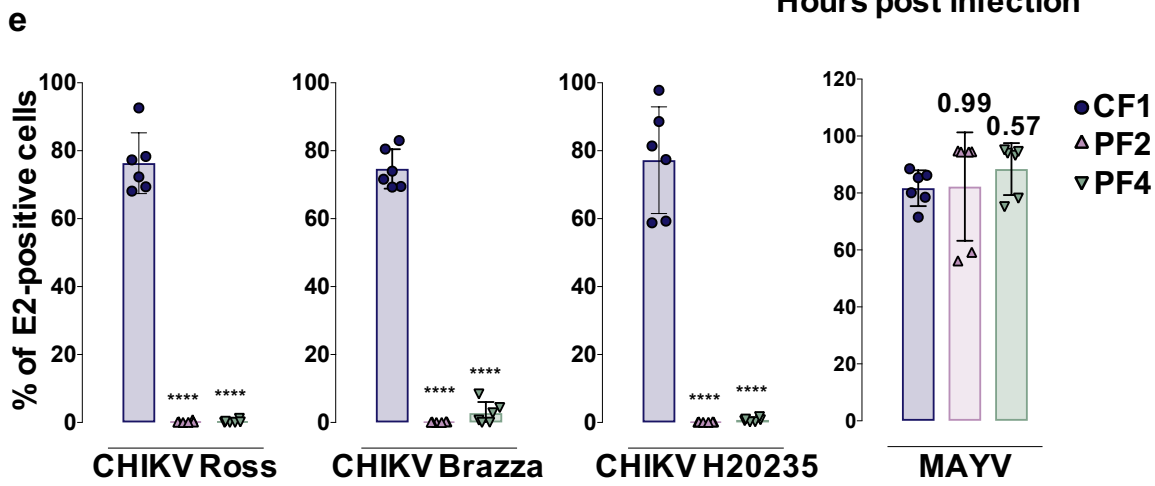
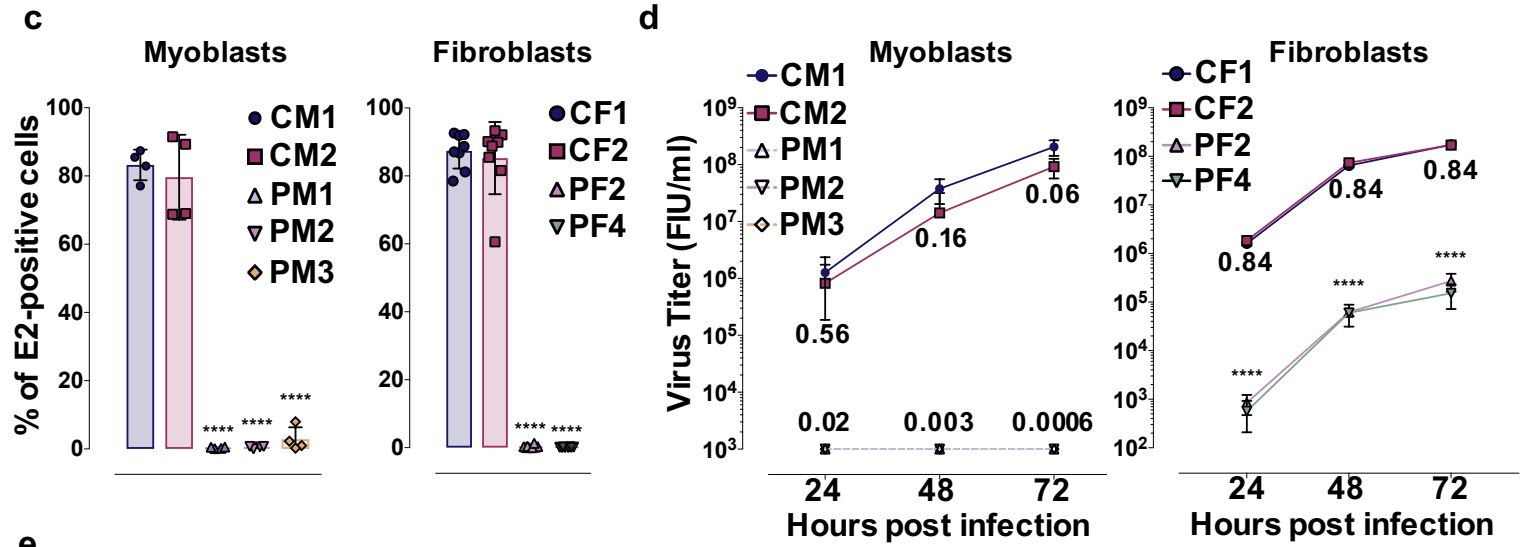
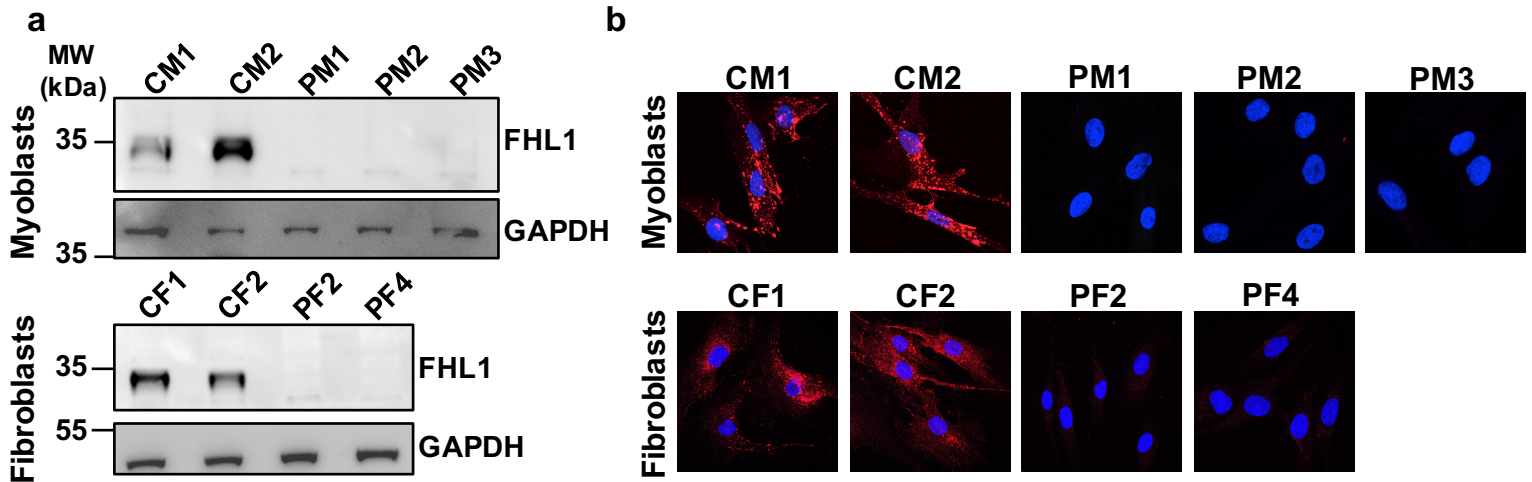

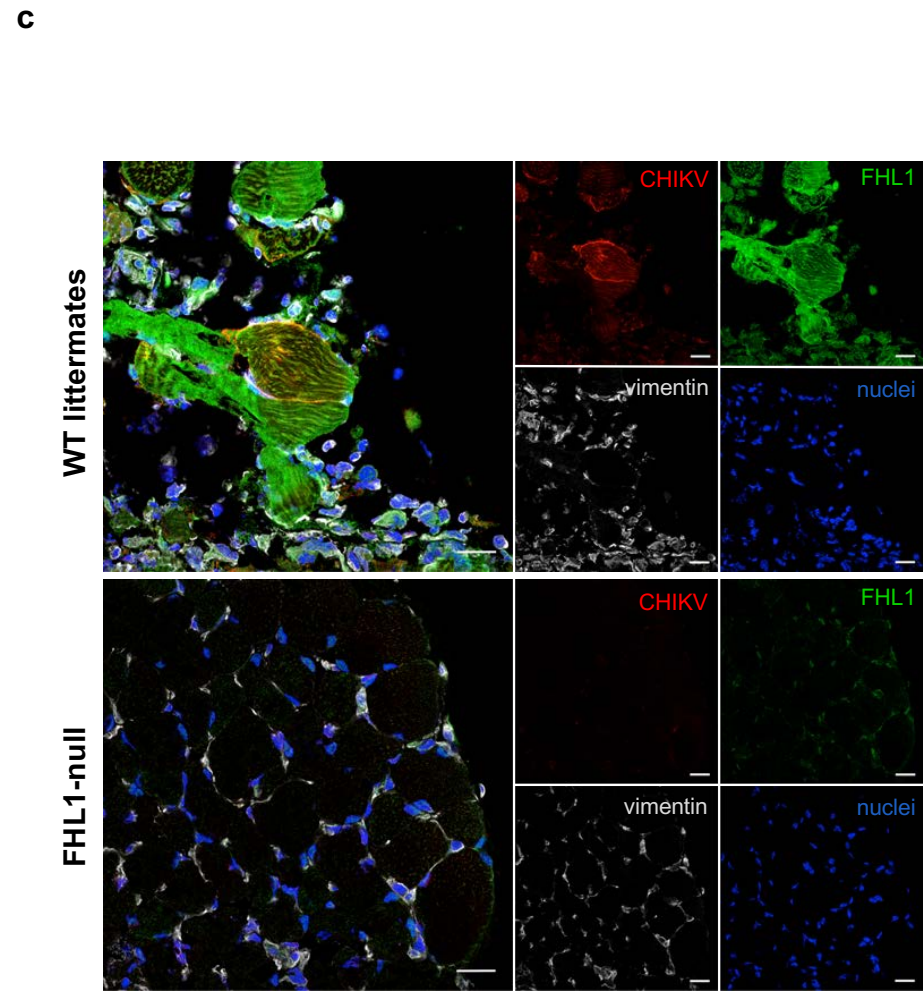
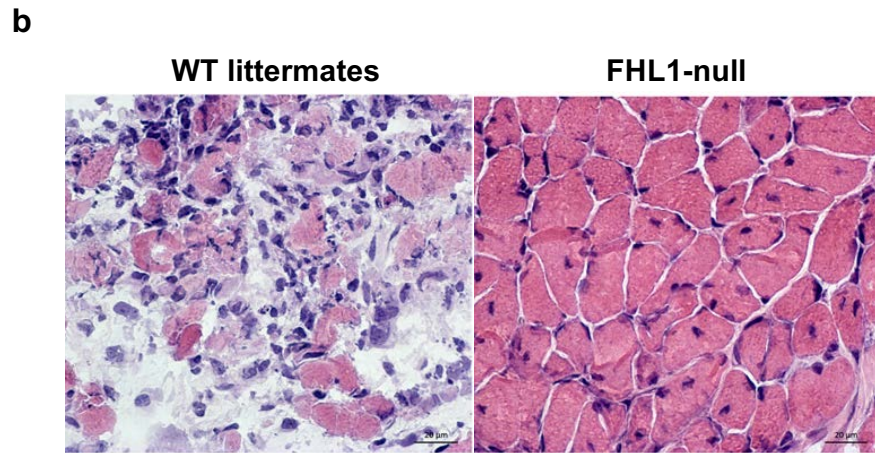
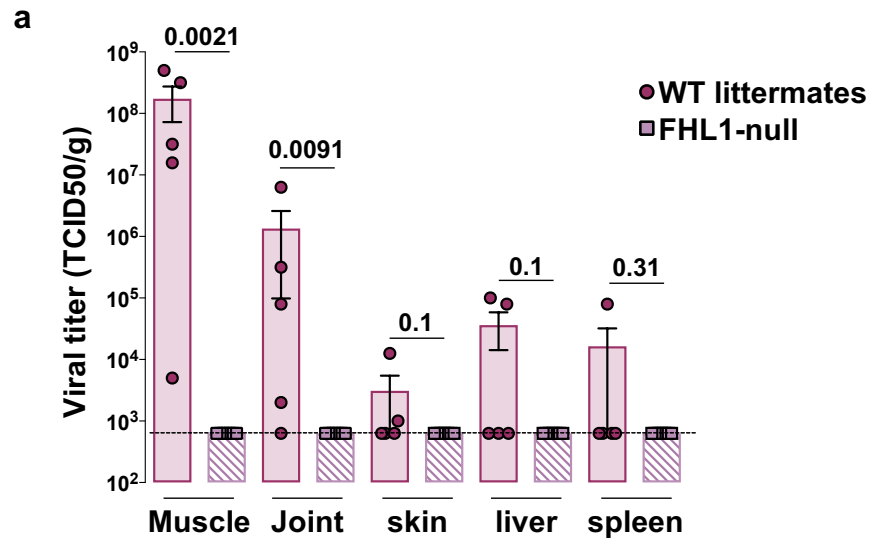

a

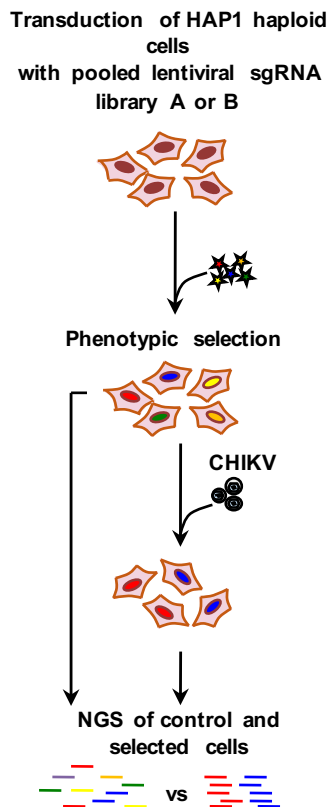

b

Ranked Genes	MAGeCK rank	RIGER Rank
FHL1	1	1
SLC35B2	2	2
PAPSS1	3	3
ELAVL1	4	4
FURIN	5	7
YBX1	6	6
GATAD1	7	5
B3GAT3	8	9
OR10W1	9	217
MTRNR2L5	11	18
COA5	12	436
POMT2	13	641
ELP5	14	47
PRIM2	16	337
NRCAM	17	238
PDE8B	18	78
EXT1	19	26
ELF2	20	10
MYT1L	21	381
CUL5	22	956
MAP4K3	23	37
ALDH18A1	24	107
ACTR10	25	13544
SLC7A6OS	26	2704
C11orf30	27	11
BID	28	8
SMOC1	30	507
SCGB1D1	32	84
RPE65	33	75
FAM124B	34	459

c

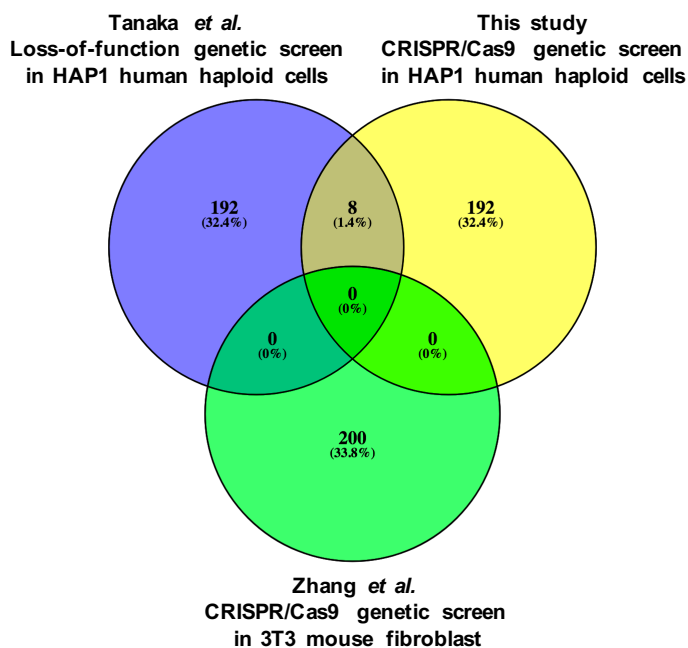

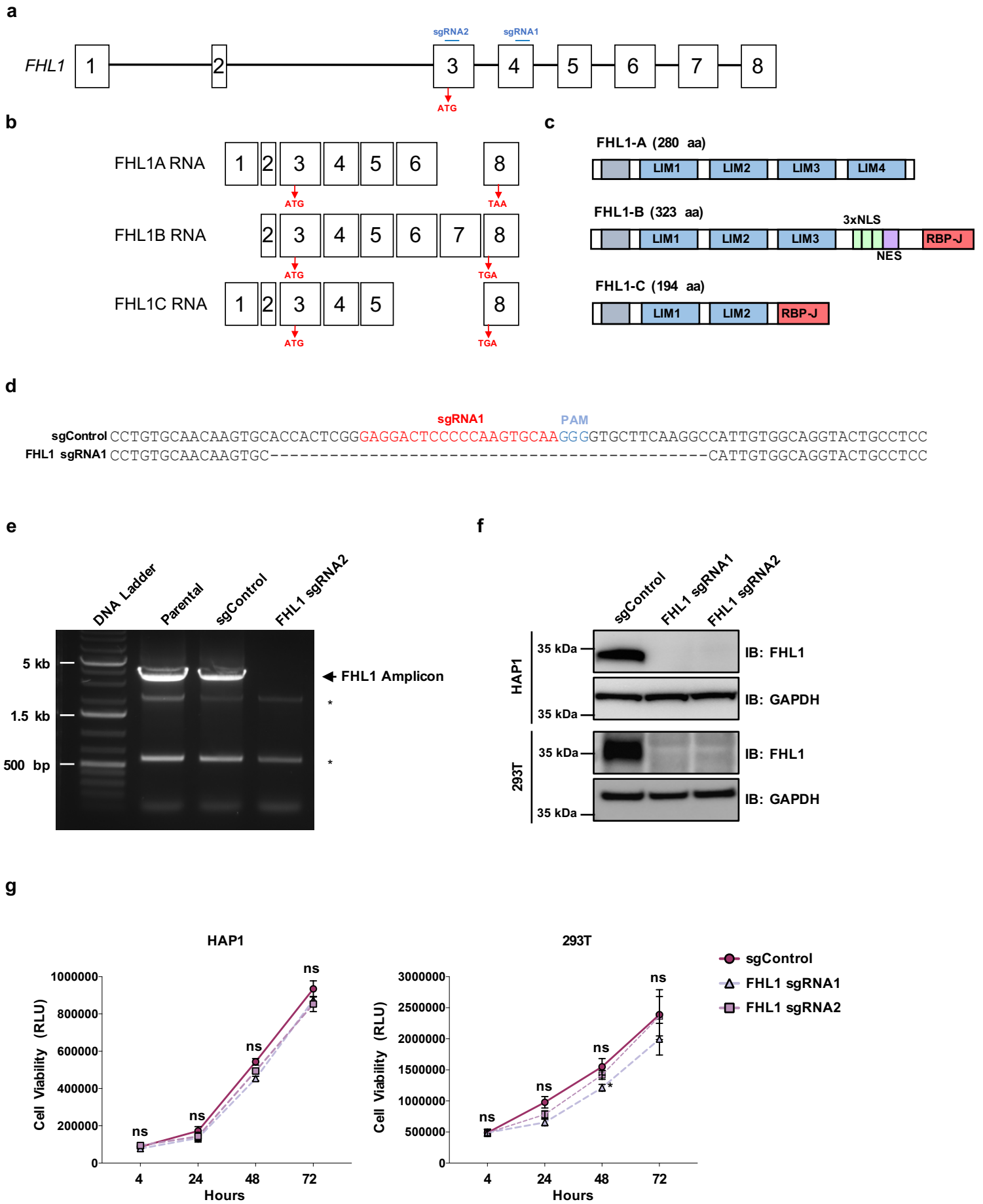

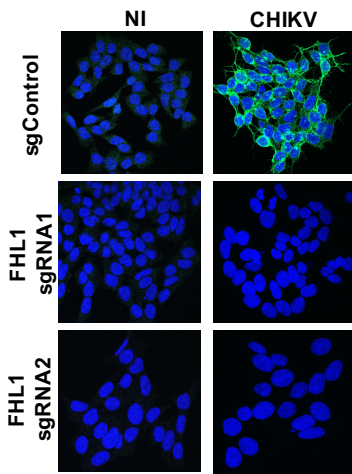
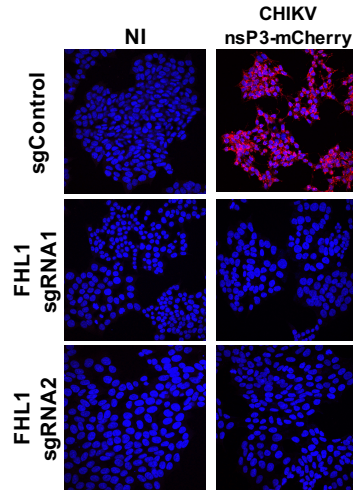
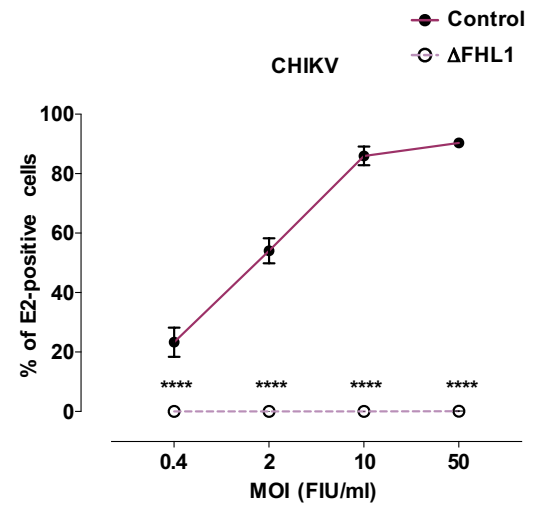
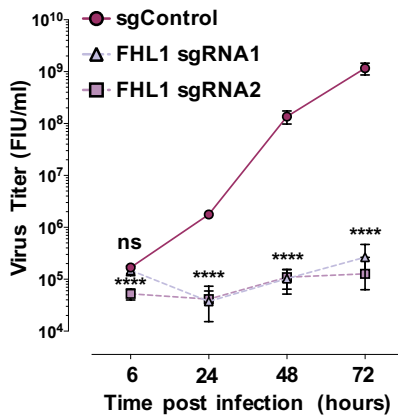
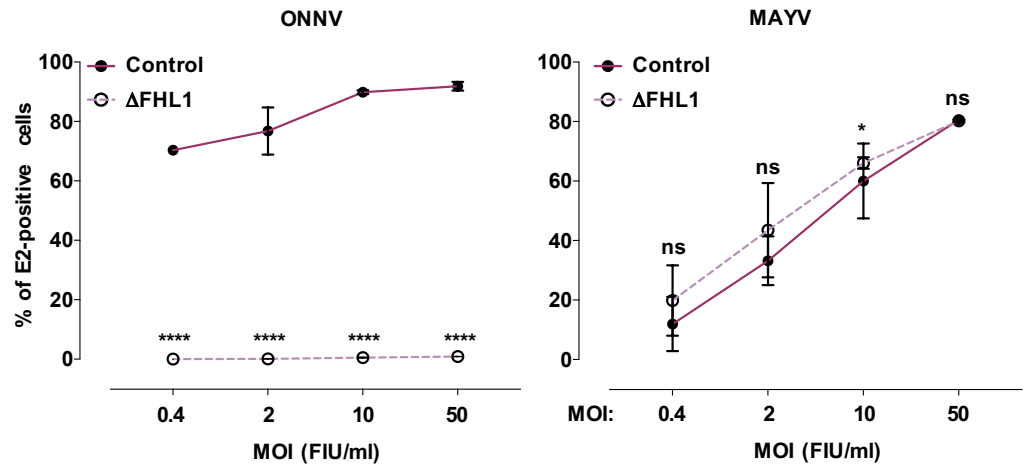
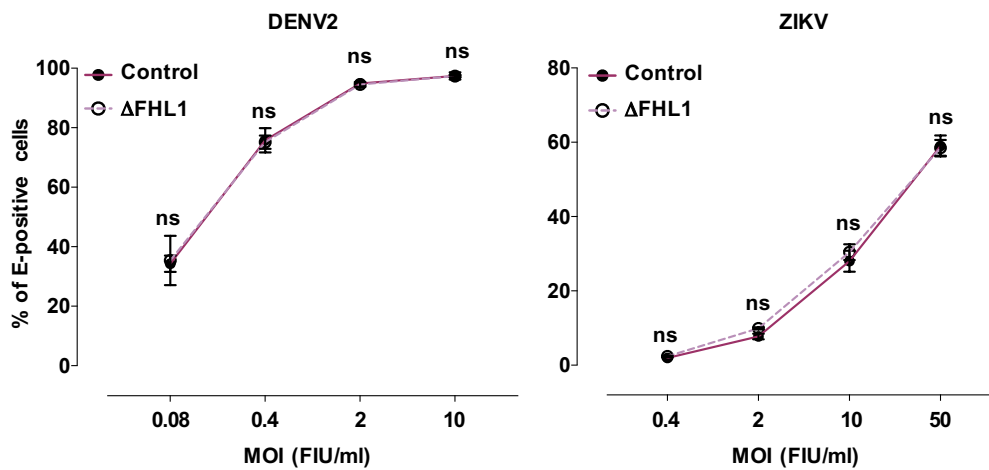
a**b****c****d****e****f**

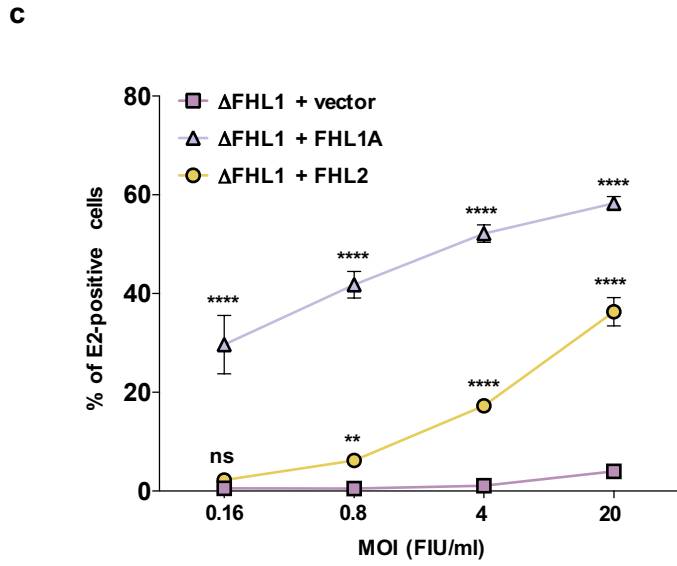
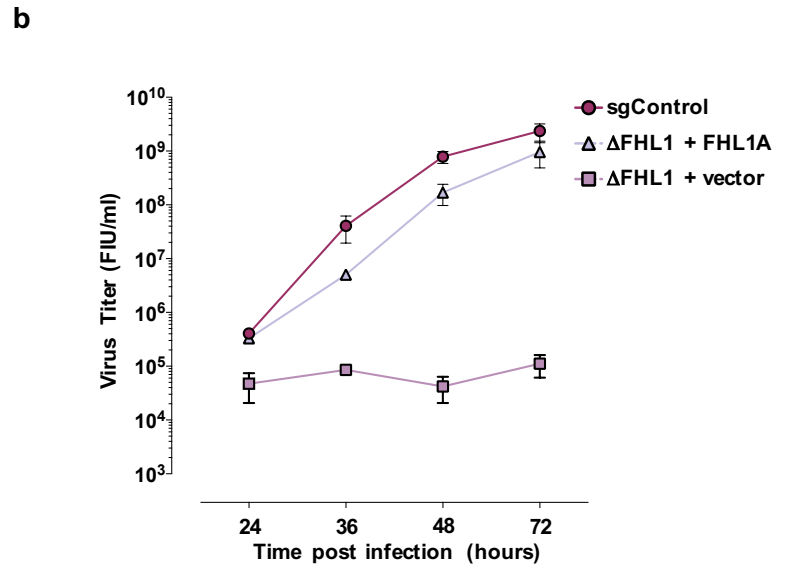
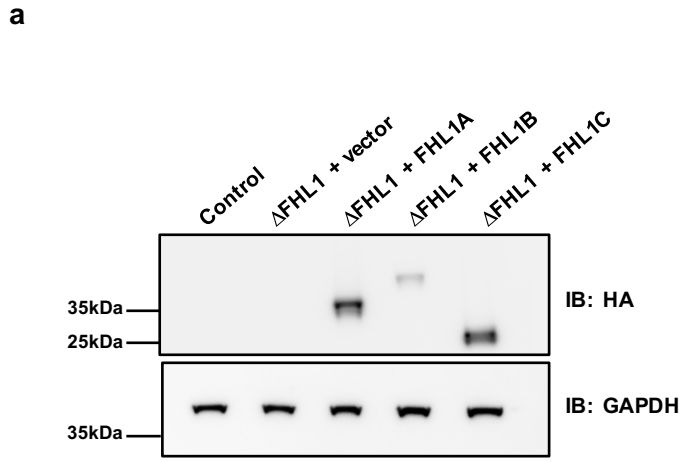

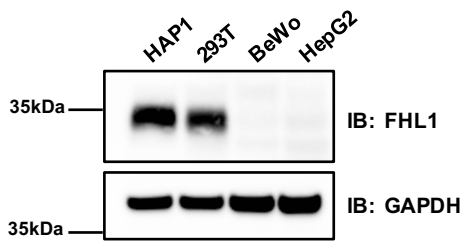
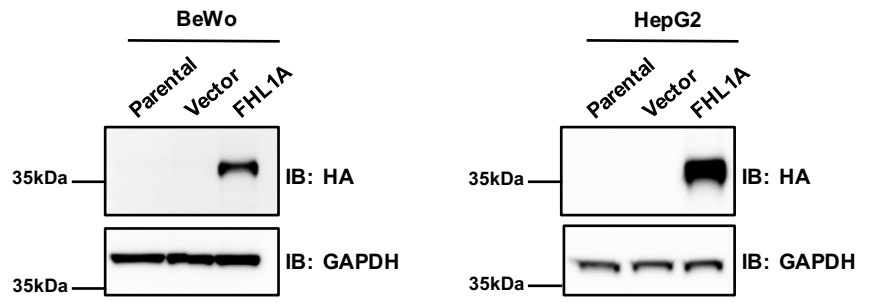
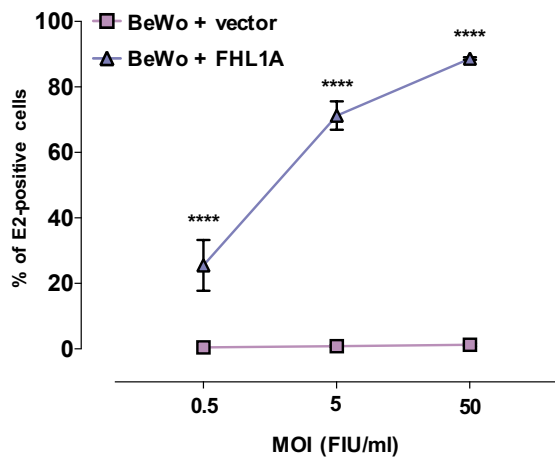
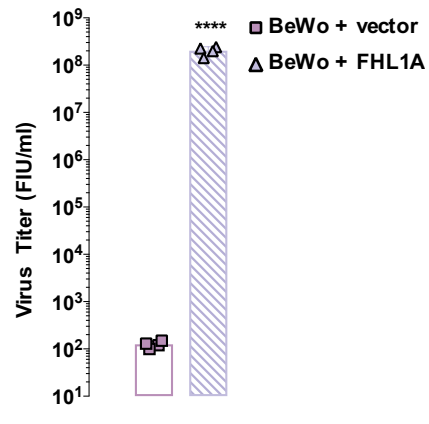
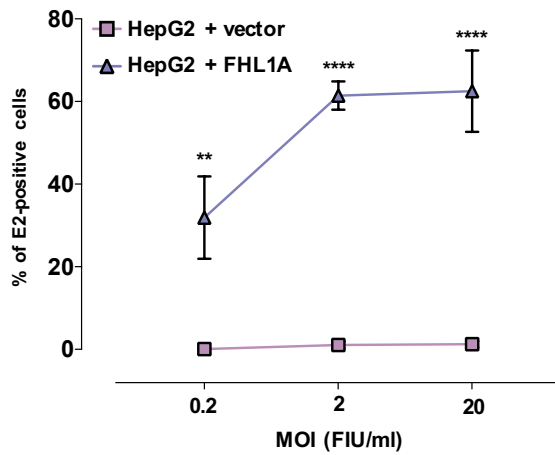
a**b****c****d****e**

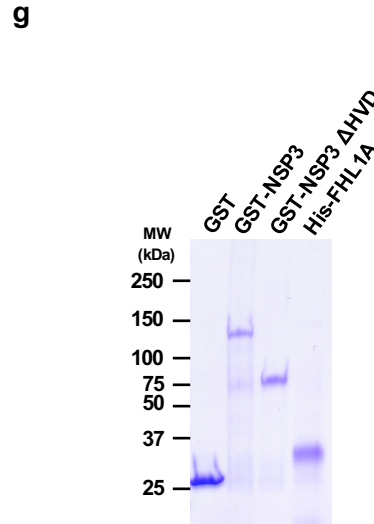
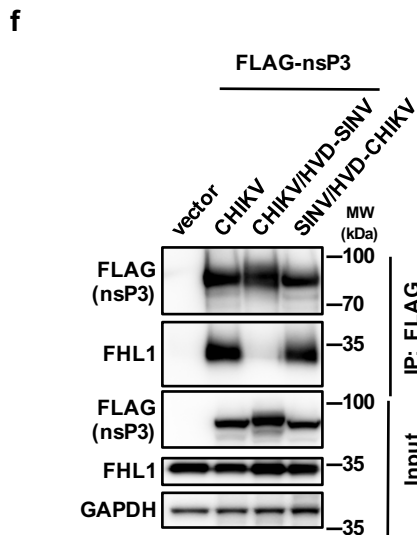
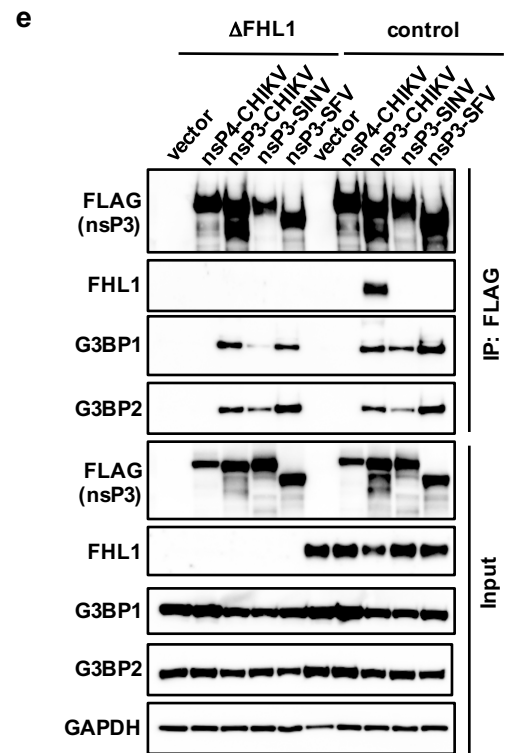
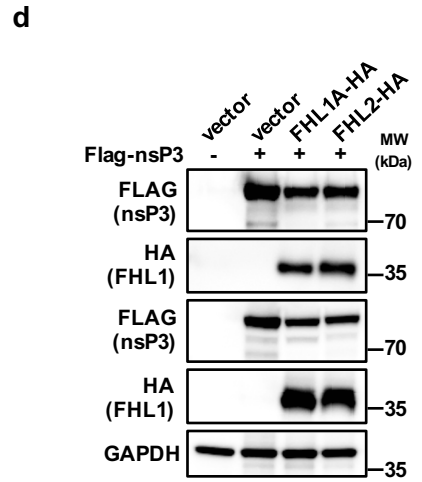
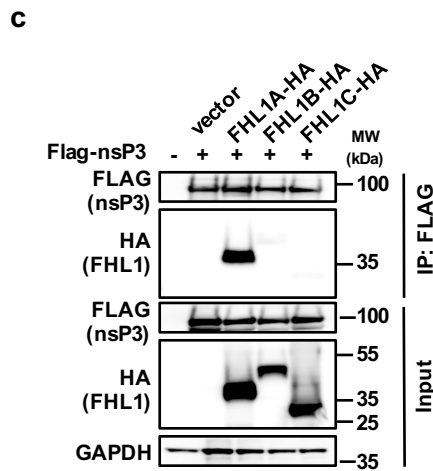
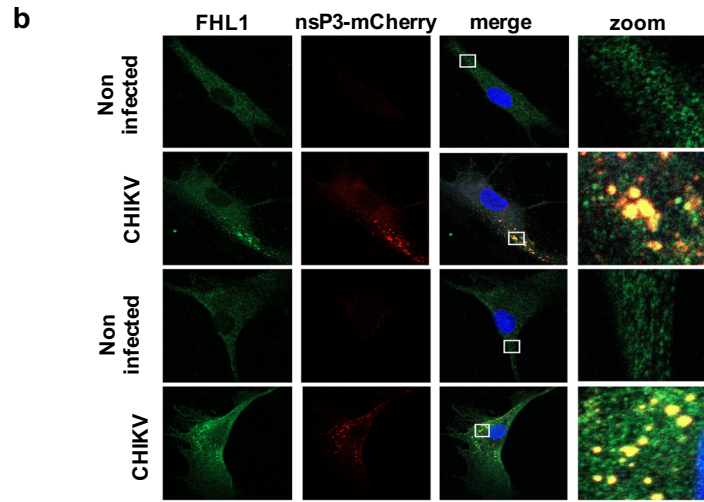
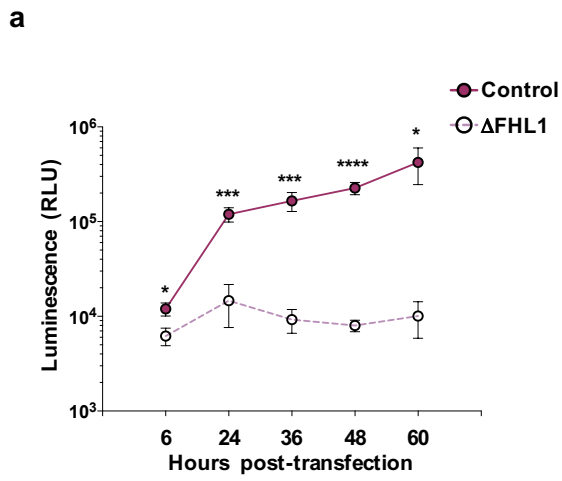

a

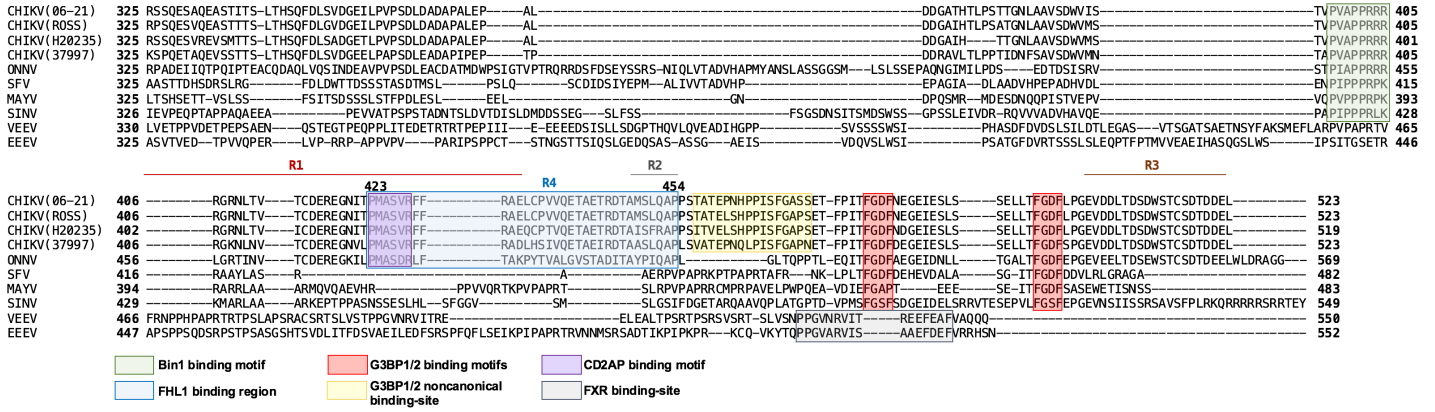

b

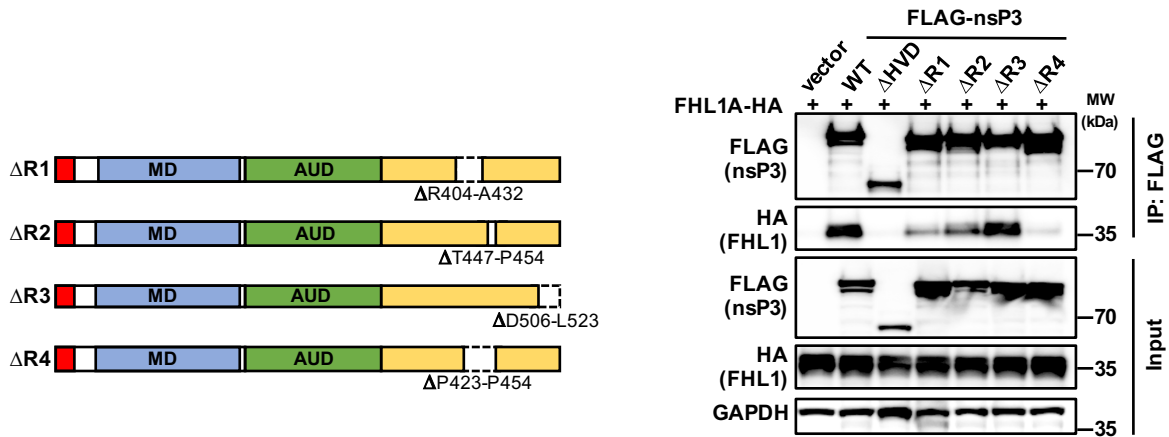

c

CHIKV-nsP3-WT PRRRRRGRNLTVTCDEREGNITPMASVRFRAELCPVVQETAETRDTAMSLQAPPS TATE 400 459
 CHIKV-nsP3-R4* -----STVPLPALRRASF ADTMEQT VAEQFPM CAEVR-----

d

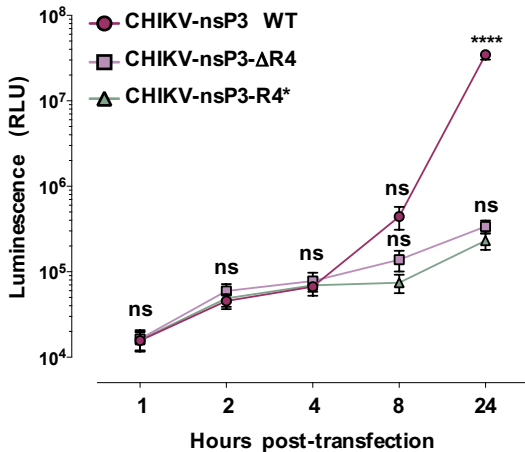

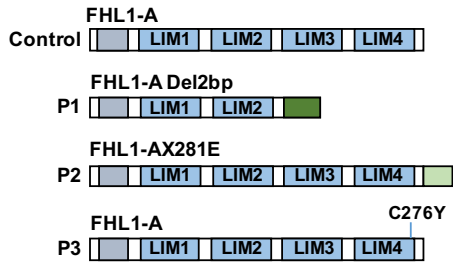
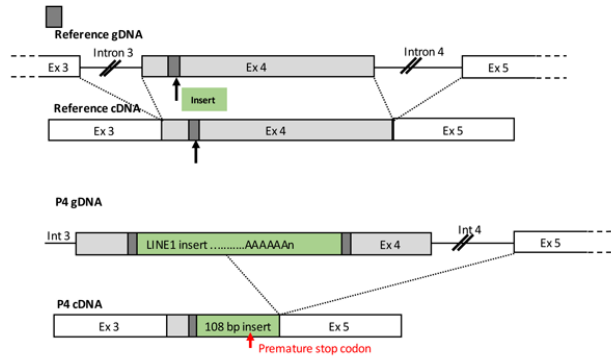
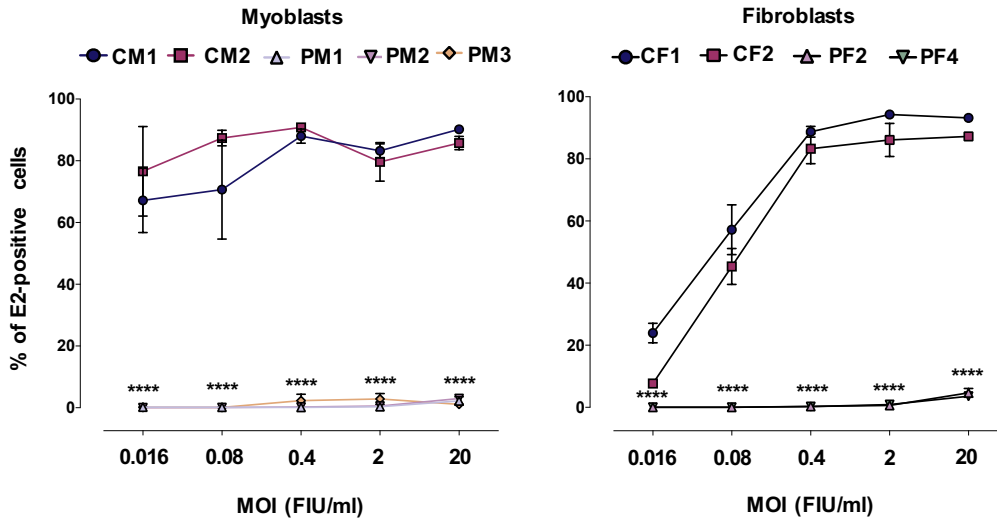
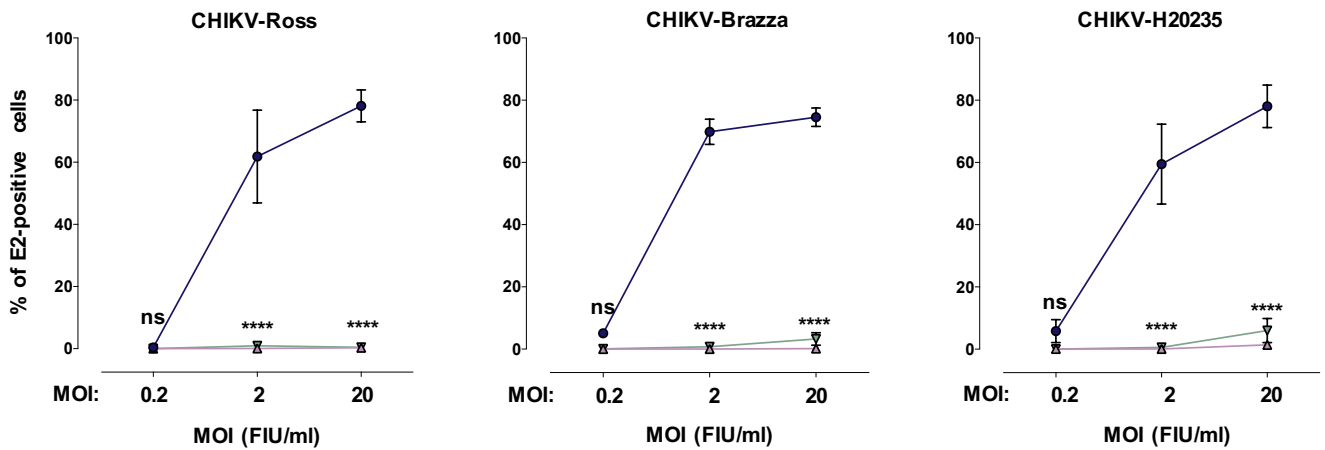
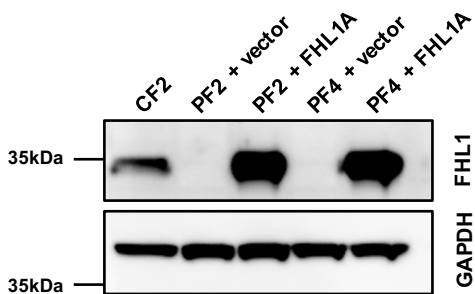
a**b****c****d****e**

a

Human FHL1A	-----MAEKFDCHYCRDPLQGKKYVQKDGHHCCCLKCFDKFCANTCV ECR	44
Murine FHL1	MASQRHSGPSSYKVGTMSEKFDCHYCRDPLQGKKYVQKDGRRHCCLKCFDKFCANTCV DCR	60
Human FHL1A	KPIGADSK EVHYKNRF WHDTCFRCAKCLHPLANETFVA KNKILCNKCT TREDSPKCKGC	104
Murine FHL1	KPISADAK EVHYKNRY WHDNCFRCAKCLHPLASETFV SKDGKILCNKCA TREDSPRCKGC	120
Human FHL1A	FKAIVAGDQ NV EYKGT V WHKDCFTCSNCKQVIGTGSF FP KGEDFYCVTCHETKFAKHCVK	164
Murine FHL1	FKAIVAGDQ NV EYKGT V WHKDCFTCSNCKQVIGTGSF FP KGEDFYCVTCHETKFAKHCVK	180
Human FHL1A	CNKAITSGGITYQDQPWHA DC FVVCVTCSSKLAGQRFTAVEDQYYCVDCYKNFVAKKCAGC	224
Murine FHL1	CNKAITSGGITYQDQPWHA EC FVVCVTCSSKLAGQRFTAVEDQYYCVDCYKNFVAKKCAGC	240
Human FHL1A	KNPITGFGKGS SV VAYEGQSWHDYCFHCKKCSVNLANKRFV FH QEQVYCPDCAKLL	280
Murine FHL1	KNPITGFGKGS SV VAYEGQSWHDYCFHCKKCSVNLANKRFV FH NEQVYCPDCAKLL	297

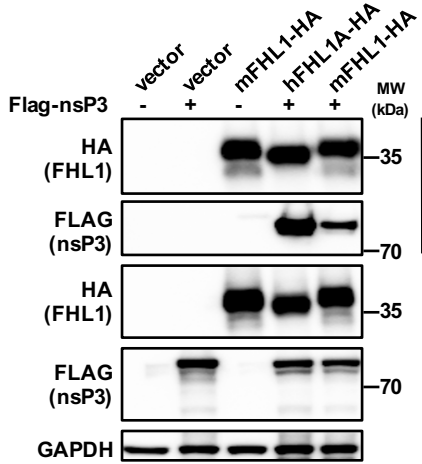
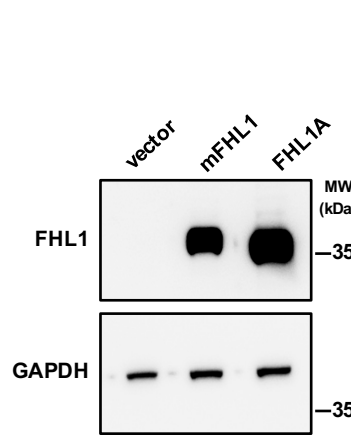
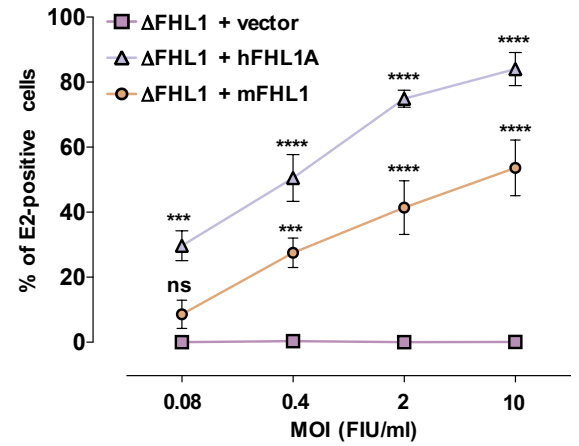
b**c****d****e**