



HAL
open science

Identification of a novel 5' alternative CFTR mRNA isoform in a patient with nasal polyposis and CFTR mutations.

Alexandre Hinzpeter, Alix de Becdelièvre, Eric Bieth, Christine Gameiro, François Brémont, Natacha Martin, Bruno Costes, Catherine Costa, Abdel Aissat, Aurélie Lorot, et al.

► To cite this version:

Alexandre Hinzpeter, Alix de Becdelièvre, Eric Bieth, Christine Gameiro, François Brémont, et al.. Identification of a novel 5' alternative CFTR mRNA isoform in a patient with nasal polyposis and CFTR mutations.. *Human Mutation*, 2014, 35 (7), pp.805-8. 10.1002/humu.22548 . inserm-01044414

HAL Id: inserm-01044414

<https://inserm.hal.science/inserm-01044414>

Submitted on 23 Jul 2014

HAL is a multi-disciplinary open access archive for the deposit and dissemination of scientific research documents, whether they are published or not. The documents may come from teaching and research institutions in France or abroad, or from public or private research centers.

L'archive ouverte pluridisciplinaire **HAL**, est destinée au dépôt et à la diffusion de documents scientifiques de niveau recherche, publiés ou non, émanant des établissements d'enseignement et de recherche français ou étrangers, des laboratoires publics ou privés.

Humu-2013-0257

Brief Report

Identification of a novel 5' alternative *CFTR* mRNA isoform in a patient with nasal polyposis and *CFTR* mutations

Alexandre Hinzpeter^{1,2#}, Alix de Becdelièvre^{1,2,3#}, Eric Bieth⁴, Christine Gameiro³, François Brémont⁵, Natacha Martin¹, Bruno Costes^{1,2}, Catherine Costa^{1,3}, Abdel Aissat^{1,2}, Aurélie Lorot^{1,2,6}, Virginie Prulière-Escabasse^{1,2,6}, Michel Goossens^{1,2,3}, Pascale Fanen^{1,2,3}, Emmanuelle Girodon^{1,3*}

¹ U955, INSERM, Créteil, France; ² Université Paris-Est, Créteil, France; ³ GH Henri Mondor, Department of Genetics, APHP, Créteil, France; ⁴ Purpan Hospital, Department of Genetics, Toulouse, France; ⁵ Pediatric CF Center, Department of Pediatric Pulmonology, Toulouse, France; ⁶ GH Henri Mondor, APHP, and CHIC, ENT Department, Créteil, France

These authors contributed equally to the work and should both be considered first authors.

***Corresponding author:** Emmanuelle Girodon, MD

INSERM U955, Equipe 11, and APHP, GH Henri Mondor, Department of Genetics

51, av du Maréchal de Lattre de Tassigny

Créteil, F-94010, France.

Tel: 33 1 49 81 48 22. Fax: 33 1 49 81 22 19.

E-mail: emmanuelle.girodon@inserm.fr

Abstract

Cystic Fibrosis may be revealed by nasal polyposis (NP) starting early in life. We performed *CFTR* DNA and mRNA analyses in the family of a 12y-old boy presenting with NP and a normal sweat test. Routine DNA analysis only showed the heterozygous c.2551C>T (p.Arg851*) mutation in the child and the father. mRNA analysis showed partial exon skipping due to c.2551C>T and a significant increase of total *CFTR* mRNA in the patient and the mother, which was attributable to the heterozygous c.-2954G>A variant in the distant promoter region, as demonstrated by *in vitro* luciferase assays. 5'RACE analysis showed the presence of a novel transcript, where the canonical exon 1 was replaced by an alternative exon called 1a-L (1a-Long). This case report could represent the first description of a *CFTR* related-disorder associated with the presence of a 5' alternative, probably non functional transcript, similar to those of fetal origin.

Key words

Cystic fibrosis, nasal polyposis, *CFTR*, alternative transcripts, transcription regulation

Nasal polyposis (NP) is a chronic inflammatory disease characterized by the presence of bilateral and diffuse nasal polyps. Although NP is common, its mechanisms of development still remain elusive. NP can be either primary, often associated with allergy, asthma, aspirin intolerance, or secondary, associated with another underlying disease, such as cystic fibrosis (CF; MIM# 219700). Prevalence of NP varies according to the studies, between 0.2-5.6% (Alobid et al., 2011) and increases with age, with a peak incidence between the fourth and fifth decades of life. In children, incidence of NP is lower, at about 0.1% in the general population (Alobid et al., 2011), and often leads to suspect CF. Indeed, NP has been described in 6-57% of CF patients according to different studies (Alobid et al., 2011; Feuillet-Fieux et al., 2011). CF is one of the most common recessive disorders in the Caucasian population and is caused by mutations in the Cystic Fibrosis Transmembrane conductance Regulator gene (*CFTR*; MIM# 602421). Over 1900 variations in this gene have been described (<http://www.genet.sickkids.on.ca/app>), causing a very wide clinical spectrum and which are also responsible for milder or monosymptomatic forms called *CFTR*-related disorders (*CFTR*-RD), such as male infertility by congenital absence of vas deferens (CBAVD), chronic pancreatitis and nasal polyposis (Bombieri et al., 2011). Sweat testing, which is a key-tool in the diagnosis of CF, may be intermediate, or even normal in *CFTR*-RD. Comprehensive molecular study of the *CFTR* gene at the genomic DNA (gDNA) level allows detecting 95-99% of mutations in classical CF, but less in *CFTR*-RD, where it is expected that remaining mild defects lie in deep intronic regions or in the *CFTR* regulatory regions and interfere with either normal splicing or expression regulation, respectively (Costa et al., 2011; Giordano et al., 2013). Identifying such mutations in gDNA by sequencing is challenging, whereas seeking the defect first by the mRNA approach has shown some efficiency (Faà et al., 2009; Costa et al., 2011).

We describe here a 12y-old boy presenting with isolated severe nasal polyposis. He had no lung disease, as assessed by thoracic tomodensitometry and pulmonary function test, and no pancreatic insufficiency or other digestive symptoms. Sweat test was negative (11 to 18 mEq/L), and measurement of nasal potential difference was not feasible due to rhinosinusitis disease.

While no other clinical sign was related to a CFTR channel dysfunction, the early occurrence of polyposis led to the suspicion of atypical CF. Full sequencing of *CFTR* coding regions, intron-exon boundaries and search for rearrangements only identified the heterozygous c.2551C>T, p.Arg851* (R851X) mutation located in exon 15 (14a according to the traditional nomenclature), of paternal origin (Figure 1A). As previously described, the c.2551C>T mutation induces two defects: the generation of a premature termination codon (p.Arg851*) in the full length mRNA and alternative splicing of exon 15 (Hinzpeter et al., 2012). This latter mRNA encodes CFTR-del831-871, a protein identified as unstable, mislocalized, non-glycosylated and non-functional (Hinzpeter et al., 2010).

CFTR mRNA studies were performed with a view to identifying a second, maternally inherited *CFTR* defect, from nasal epithelial cells of the index case and his parents. The qualitative study consisted of PCR amplification of cDNA in different fragments encompassing all *CFTR* exons (Costa et al., 2011). This analysis only evidenced the abnormal exclusion of exon 15, caused by the c.2551C>T mutation, in the patient and his father (Figure 1A). Relative quantification of *CFTR* mRNA level was performed by real-time PCR with normalization to keratin 18 (*KRT18*), a marker of ciliated and secretory epithelial cells (Linde et al. 2007), using Taqman probes (TaqMan FAM/NFQ-MGB probe format, *CFTR*: Hs00357011_m1, located at the boundary of *CFTR* exons 20/21; *KRT18*: Hs01920599_gH, Applied Biosystems), as previously described (Hinzpeter et al., 2010) (Supp. Materials and Methods). Results were controlled using a widely

used housekeeping gene as another reference gene, Glyceraldehyde-3-Phosphate Dehydrogenase (*GAPDH*), (Ramalho et al. 2011) according to the instructions of the manufacturer (*GAPDH*: AX-004253-00-0400, Thermo Scientific, Solaris qPCR assay). *CFTR* mRNA level was significantly reduced in the father to $38\% \pm 8\%$ ($p < 0.01$) compared to eight different control individuals ($100\% \pm 30\%$, $n=8$) tested for *CFTR/KRT18* (Figure 1B). Such a diminution can be in part due to degradation of the mRNA form containing the c.2551C>T mutation, via the nonsense-mediated decay pathway (NMD) which was shown to vary between mutations and even between individuals carrying the same mutation (Linde et al., 2007). Inter-individual variation in *CFTR* mRNA amount has also been documented, regardless of NMD (Masvidal et al., 2013). Finally, no mutation that could impair *CFTR* mRNA expression was found in the patient's father after complete sequencing of the coding region and the promoter region (c.-3897 to c.-1). By contrast, surprisingly, the index case exhibited a significant ($p < 0.01$) increase in *CFTR* mRNA to $160\% \pm 34\%$ of the controls ($n=8$), similar to his mother ($151\% \pm 32\%$, $p < 0.01$) (Figure 1B). Similar results were obtained using *GAPDH* as a reference gene (57% in the father, 148% in the patient and 227% in the mother, as compared with two control individuals). Among the 1900 *CFTR* gene mutations reported, few have been described in the promoter region reaching down to 6kb, in CF and CFTR-RD patients (Romey et al., 2000; Giordano et al., 2013). The first description of an increased amount of *CFTR* mRNA was suggested from *in vitro* experiments in the case of a complex allele, c.[-234T>A;1647T>G] (-102T>A in *cis* with p.Ser549Arg). In this case, the promoter mutation c.-234T>A was suspected to attenuate the effect of the c.1647T>G mutation by increasing the amount of the mutant channel that has a residual function (Romey et al., 2000). Very recently, Giordano et coll. described three novel promoter variants associated with an *in vitro* increased *CFTR* promoter activity, which were

nonetheless supposed to attenuate as well the deleterious effect of other, undetected, in *cis* mutations (Giordano et al., 2013). Sequencing of the *CFTR* promoter gDNA, from c.-3897 to c.-1, was performed in our patient in order to identify a putative mutation affecting the regulation of transcription. A single heterozygous sequence variation was identified, c.-2954G>A (chr7:117,117,195G>A (GRCh7/hg19)) in the mother and the child, and not in the father (Figure 1C).

This variant has been recently reported, notably in the dbSNP 135 database as rs145885255:G>A, in the German and other European populations with an allelic frequency of 0.14% and 0.34%, respectively. Testing this mutation in a panel of 100 healthy individuals led to find a 0.5% allelic frequency in the French population (1/200 chromosomes). However, nasal epithelial cells from the only individual identified with this variant in this group were not available to study mRNA. The variant was not found in a series of 14 patients having nasal polyposis and only one identified *CFTR* mutation.

A functional assay was performed to assess if this variant was related to the increase in *CFTR* mRNA levels observed in the patient and his mother. We used two constructs of different lengths of the *CFTR* promoter for cross-validation (from c.-3068 to c.-47 and c.-3628 to c.-47), driving a luciferase reporter gene, as illustrated in Figure 2A. Both WT and mutated plasmids were transfected in the bronchial BEAS-2B and CF IB3-1 epithelial cell lines and the Firefly luciferase activity was normalized to the Renilla luciferase activity (Supp. Materials and Methods). In BEAS-2B cells, the c.-2954G>A mutation significantly increased the promoter activity by 2-fold with the c.-3068 construct (2.3 ± 0.3 , $p < 0.03$, $n=3$) and by 5-fold with the c.-3628 construct (5.6 ± 0.5 , $p < 0.004$, $n=5$) (Figure 2B). In IB3-1, the increase in transcriptional activity of the mutated promoter was confirmed by an 8-fold gain with the c.-3628 construct (8.0

± 2.0 , $p < 0.02$, $n=6$) (data not shown). Similar results were obtained in the intestinal Caco-2 cell line, where the c.-2954G>A mutation increased the promoter activity by 1.6-fold with the c.-3068 construct (1.6 ± 0.02 , $p < 0.003$, $n=3$) and by 2-fold with the c.-3628 construct (2.6 ± 0.5 , $p < 0.004$, $n=3$) (data not shown). This increased transcriptional activity could be the consequence of alteration of transcription factor binding sites, as suggested by *in silico* analysis of the concerned region. Nonetheless, the *CFTR* gene transcription regulation is somewhat complex, with multiple interplaying factors located outside the promoter region (McCarthy and Harris, 2005). The characterization of the underlying mechanism responsible for the increased transcriptional activity due to c.-2954G>A is under investigation.

As an increased level of normal *CFTR* transcripts was not expected to be associated with CF or a *CFTR*-RD, we hypothesized the production of an abnormal transcript in its 5' segment, induced or favoured by the mutation and that could not be detected by our protocol set-up for *CFTR* mRNA studies, since the first 5' primer is located in exon 1. We thus looked for a 5' alternative transcript in nasal epithelial cells using the 5' Rapid Amplification of cDNA Ends (5'RACE) technology (FirstChoice® RLM-RACE Kit, Life Technologies, Paris, France) (Supp. Materials and Methods). Analysis was performed in three unrelated controls without any CF symptom or *CFTR* mutation detected upon gDNA and cDNA analysis, from nasal cells for one control (Control 1) and primary cultures of nasal cells (Prulière-Escabasse et al., 2010) for the other two. Results revealed the presence of two PCR products for Control 1 and only one PCR product in the other two after separation in a 2% agarose gel (Figure 2C). These products corresponded to known *CFTR* transcripts including exons 1 to 4 and differing by the length of the 5'UTR, as assessed by sequencing analysis: one initiation start site was at c.-71 (Yoshimura et al., 1991), observed in the three controls, and the second one at c.-122 (Riordan et al., 1989), observed only

in Control 1 (Figure 2D and Figure 2E). In the patient, two isoforms were detected (Figure 2C), one containing exons 1 to 4 (initiation site at c.-71) and one containing exons 2 to 4, preceded by a sequence corresponding to the previously described exon 1a (Koh et al., 1993; Mouchel et al., 2003) plus 33 bp upstream (initiation site at c.-666, end at c.-401) (Supp. Figure S1). We called this novel exon 1a-L for 1a-Long (Figure 2D and Figure 2E). Alternative 5' *CFTR* transcripts have never been identified in CF or CFTR-RD. Two 5' alternative transcripts have been previously described, both containing exon -1a (c.-937 to c.-750) as the first exon: -1a, 1a, 2 and -1a, 2, firstly in the human T84 carcinoma cell line (Koh et al., 1993) and further, notably in the human developing fetal lung (Mouchel et al., 2003) (Figure 2E). Neither of these transcripts was predicted to encode a fully functional CFTR channel but they were hypothesized to have regulatory functions in the normal developing lung, with a substantial decreasing expression during gestation (Mouchel et al., 2003; Lewandowska et al., 2010). We describe here for the first time in a patient, a novel, third 5' alternative isoform (1a-L, 2), which excludes exon -1a and resembles to these *CFTR* fetal isoforms. The 5' additional sequence of 33 bp contains one AUG codon, so that exon 1a-L contains two AUG codons and a CUG putative initiation codon. The use of the first AUG would lead to a stop UGA codon, 38 codons downstream, whereas the use of the second AUG and CUG codons would not lead to a functional CFTR protein, as shown for the previously described 5' alternative transcripts (Lewandowska et al., 2010).

Although the link between the increased *CFTR* promoter activity and the presence of an abnormal transcript is not established, it is tempting to speculate that the existence of a 5' alternative *CFTR* mRNA isoform in our patient reflects a defect in the regulation of *CFTR* expression. It is however not clear if production of the abnormal *CFTR* transcript is induced by a pathological state such as proliferation of nasal cells or inflammation or, alternatively, if the 1a-

L-containing transcript induces CFTR dysfunction. CFTR dysfunction could then be due to impaired translation and subsequent reduction of functional CFTR, the presence of the abnormal mRNA isoform *per se*, or a combination of both. Taken together, our observation highlights the importance of searching for such alternative transcripts in patients presenting either isolated NP or another CFTR-RD, as well as in patients carrying promoter variants recently shown to increase the *CFTR* promoter activity (Giordano et al., 2013).

In conclusion, this case report could represent the first description of a CFTR disease associated with the presence of a novel 5' alternative transcript. This would thereby lead to search for a new mutation type, especially in patients with CFTR-RD. Such mutations could also act as modifiers in the framework of complex alleles. This observation finally illustrates the importance of mRNA studies in the new era of next-generation sequencing, which inevitably will lead to identify a great number of variants of unknown clinical significance.

Acknowledgments

The authors wish to thank B. Boissier, A. LeFloch and R. Medina for valuable technical assistance and J. Percodani and M.N. Calmels for patients' nasal cells sampling. Mario Ollero is acknowledged for re-reading the English of the manuscript. This work was supported by the French CF Foundation « Vaincre La Mucoviscidose ».

Disclosure Statement: The authors declare no conflict of interest.

References

- Alobid I, Antón E, Armengot M, Chao J, Colás C, del Cuvillo A, Dávila I, Dordal MT, Escobar C, Fernández-Parra B, Gras-Cabrerizo JR, Ibanez MD et al. 2011. SEAIC-SEORL. Consensus Document on Nasal Polyposis. POLINA Project. *J Investig Allergol Clin Immunol* 21 Suppl 1:1-58.
- Bombieri C, Claustres M, De Boeck K, Derichs N, Dodge J, Girodon E, Sermet I, Schwarz M, Tzetis M, Wilschanski M, Bareil C, Bilton D et al. 2011. Recommendations for the classification of diseases as CFTR-related disorders. *J Cyst Fibros* 10 Suppl 2:S86-102.
- Costa C, Pruliere-Escabasse V, de Becdelievre A, Gameiro C, Golmard L, Guittard C, Bassinet L, Bienvenu T, Georges MD, Epaud R, Bieth E, Giurgea I et al. 2011. A recurrent deep-intronic splicing CF mutation emphasizes the importance of mRNA studies in clinical practice. *J Cyst Fibros* 10:479-482.
- Faà V, Incani F, Meloni A, Corda D, Masala M, Baffico AM, Seia M, Cao A, Rosatelli MC. 2009. Characterization of a disease-associated mutation affecting a putative splicing regulatory element in intron 6b of the cystic fibrosis transmembrane conductance regulator (CFTR) gene. *J Biol Chem* 284:30024-30031.
- Feuillet-Fieux MN, Lenoir G, Sermet I, Elie C, Djadi-Prat J, Ferrec M, Magen M, Couloigner V, Manach Y, Lacour B, Bonnefont JP. 2011. Nasal polyposis and cystic fibrosis(CF): review of the literature. *Rhinology* 49:347-355.
- Giordano S, Amato F, Elce A, Monti M, Iannone C, Pucci P, Seia M, Angioni A, Zarrilli F, Castaldo G, Tomaiuolo R. 2013. Molecular and Functional Analysis of the Large 5' Promoter Region of CFTR Gene Revealed Pathogenic Mutations in CF and CFTR-Related Disorders. *J Mol Diagn* 15(3):331-40.

- Hinzpeter A, Aissat A, Sondo E, Costa C, Arous N, Gameiro C, Martin N, Tarze A, Weiss L, de Becdelièvre A, Costes B, Goossens M et al. 2010. Alternative splicing at a NAGNAG acceptor site as a novel phenotype modifier. *PLoS Genet* 6(10).
- Hinzpeter A, Aissat A, de Becdelièvre A, Bieth E, Sondo E, Martin N, Costes B, Costa C, Goossens M, Galiotta LJ, Girodon E, Fanen P. 2012. Alternative splicing of in-frame exon associated with premature termination codons: implications for readthrough therapies. *Hum Mutat* 34(2):287-91.
- Koh J, Sferra TJ, Collins FS. 1993. Characterization of the cystic fibrosis transmembrane conductance regulator promoter region. Chromatin context and tissue-specificity. *J Biol Chem* 268:15912-15921.
- Lewandowska MA, Costa FF, Bischof JM, Williams SH, Soares MB, Harris A. 2010. Multiple mechanisms influence regulation of the cystic fibrosis transmembrane conductance regulator gene promoter. *Am J Respir Cell Mol Biol* 43:334-341.
- Linde L, Boelz S, Nissim-Rafinia M, Oren YS, Wilschanski M, Yaacov Y, Virgilis D, Neu-Yilik G, Kulozik AE, Kerem E, Kerem B. 2007. Nonsense-mediated mRNA decay affects nonsense transcript levels and governs response of cystic fibrosis patients to gentamicin. *J Clin Invest* 117: 683-692.
- Maquat LE. 1995. When cells stop making sense: effects of nonsense codons on RNA metabolism in vertebrate cells. *RNA* 1:453-465.
- Masvidal L, Igreja S, Ramos MD, Alvarez A, de Gracia J, Ramalho A, Amaral MD, Larriba S, Casals T. 2013. Assessing the residual CFTR gene expression in human nasal epithelium cells bearing CFTR splicing mutations causing cystic fibrosis. *Eur J Hum Genet*. 2013 Oct 16. doi: 10.1038/ejhg.2013.238.

- McCarthy VA, Harris A. 2005. The CFTR gene and regulation of its expression. *Pediatr Pulmonol* 40:1-8.
- Mouchel N, Broackes-Carter F, Harris A. 2003. Alternative 5' exons of the CFTR gene show developmental regulation. *Hum Mol Genet* 12:759-769.
- Prulière-Escabasse V, Clerici C, Vuagniaux G, Coste A, Escudier E, Planès C. 2010. Effect of neutrophil elastase and its inhibitor EPI-hNE4 on transepithelial sodium transport across normal and cystic fibrosis human nasal epithelial cells. *Respir Res* 11: 141.
- Ramalho AS, Clarke LA, Amaral MD. 2011. Quantification of CFTR transcripts. *Methods Mol Biol* 741: 115-135.
- Riordan JR, Rommens JM, Kerem B, Alon N, Rozmahel R, Grzelczak Z, Zielenski J, Lok S, Plavsic N, Chou JL. 1989. Identification of the cystic fibrosis gene: cloning and characterization of complementary DNA. *Science* 245:1066-1073.
- Romey MC, Pallares-Ruiz N, Mange A, Mettling C, Peytavi R, Demaille J, Claustres M. 2000. A naturally occurring sequence variation that creates a YY1 element is associated with increased cystic fibrosis transmembrane conductance regulator gene expression. *J Biol Chem* 275:3561-3567.
- Yoshimura K, Nakamura H, Trapnell BC, Dalemans W, Pavirani A, Lecocq JP, Crystal RG. 1991. The cystic fibrosis gene has a "housekeeping"-type promoter and is expressed at low levels in cells of epithelial origin. *J Biol Chem* 266:9140-9144.

Figure legends

Figure 1. Mutation identification and *in vivo* transcript analysis.

NM_000492.3 and NG_016465.1 were used as the cDNA and genomic reference sequences, respectively. (A) Sequence corresponding to the c.2551C>T (p.Arg851*) mutation, identified in the child and his father. (B) Semi-quantification of total *CFTR* transcripts measured from nasal epithelial cells. Significant results were indicated by a star (* when $p < 0.01$). (C) Sequence corresponding to the c.-2954G>A mutation, identified in the child and his mother.

Figure 2. *In vitro* functional evaluation of the c.-2954G>A mutation and identification of a novel 5' alternative transcript

(A) Schematic representation of *CFTR* 5' UTR regions cloned in front of the *Luciferase* gene. The construct spans from either c.-3068 or c.-3628 to c.-47. The position of the tested c.-2954G>A mutation is indicated. (B) Luciferase activity measured in BEAS-2B cells transfected with the indicated construct. Firefly luciferase activity was normalized to levels of co-transfected Renilla luciferase activity. Significant statistical t-test values were indicated by stars (** when $p < 0.001$, $n=3$ to 5). WT: wild-type; Mut: mutant sequence containing c.-2954G>A. (C) Identification of alternative *CFTR* isoforms using 5'RACE and subsequent nested PCR, with 5' RACE primers (Adap), which hybridize to all capped mRNAs and 3' primers specific to *CFTR* exon 4. gDNA: genomic DNA; NegCtr: negative control, with H₂O instead of RNA for the nested PCR performed after 5'RACE. Control 1 with two normal transcripts is illustrated. (D) Schematic representation of the amplified alternative *CFTR* isoforms. The 549-bp and 407-bp-long fragments were observed in the patient and the 458-bp and 407-bp-long fragments in Control 1. (E) Schematic representation of the transcripts observed in Control 1 (upper), in our

patient with inclusion of exon 1a-L (middle), and in the human developing fetal lung, including exons -1a and 1a as previously described (lower). The arrows correspond to transcription start sites. Splicing events leading to either the wild-type transcript (solid line) or 5' alternative transcripts (dashed lines) are indicated. First and last nucleotides of the alternative exons are indicated.

A

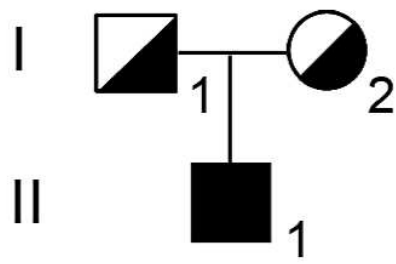

I1/II1 c.2551C>T

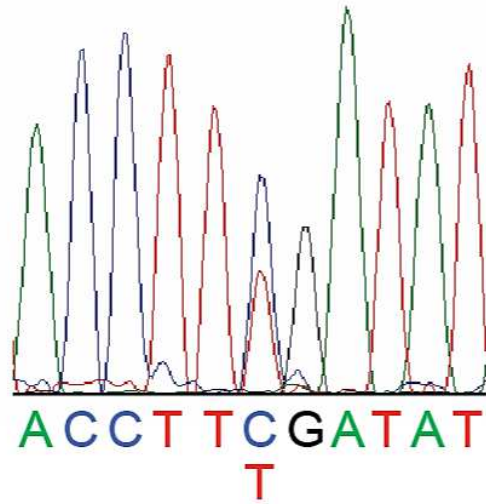

B

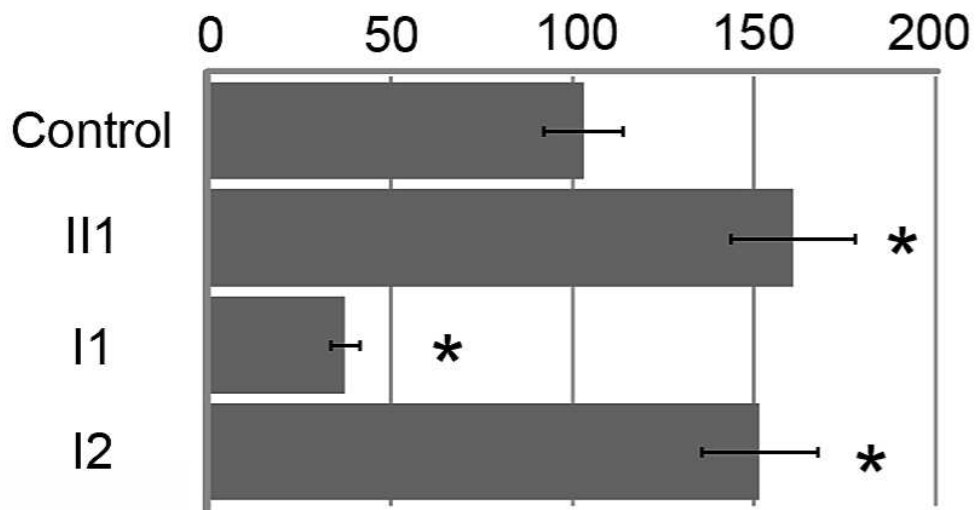
Relative level of *CFTR* transcripts

C

I1

I2/II1 c.-2954G>A

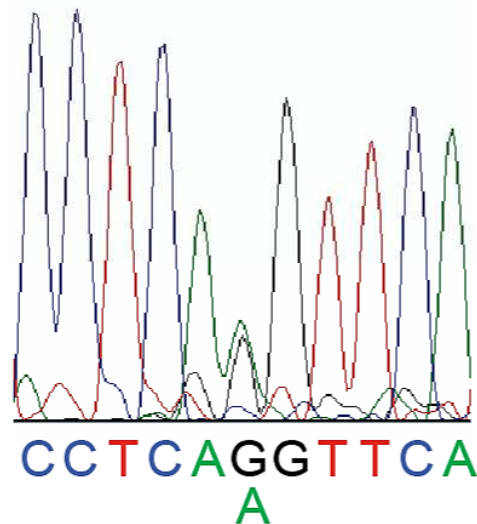
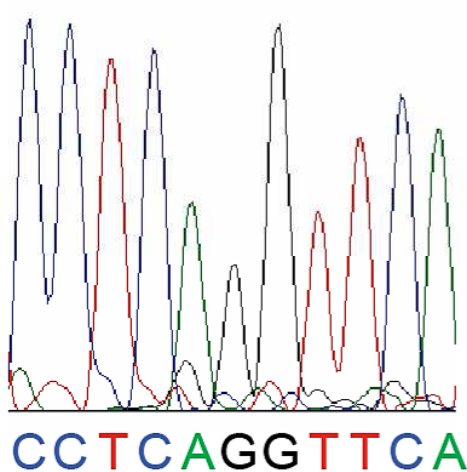

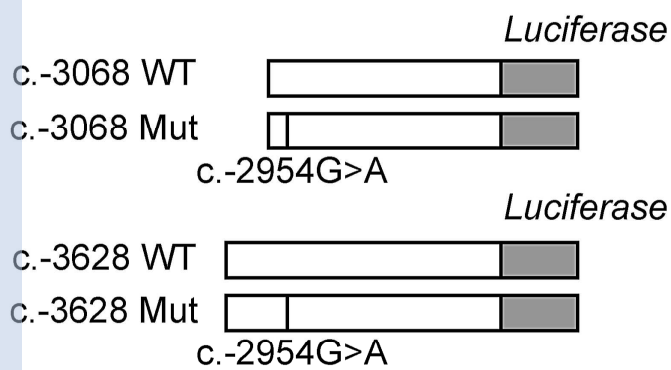
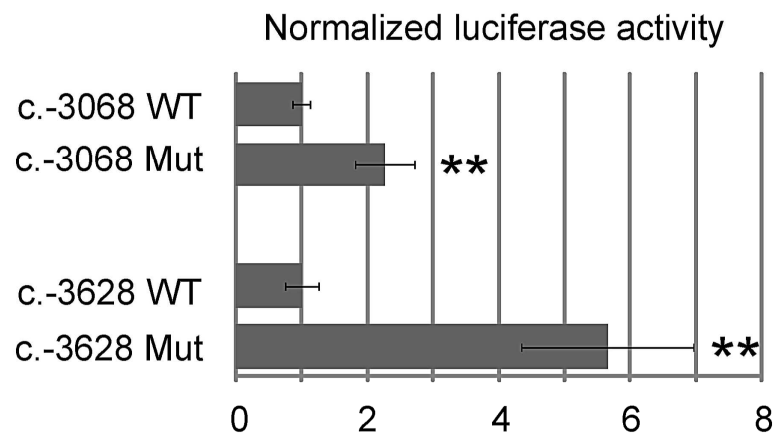
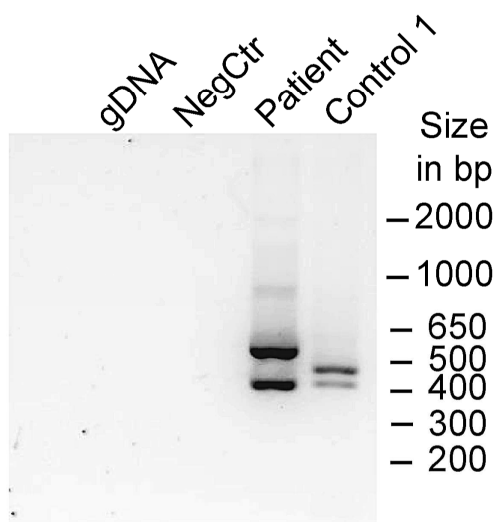
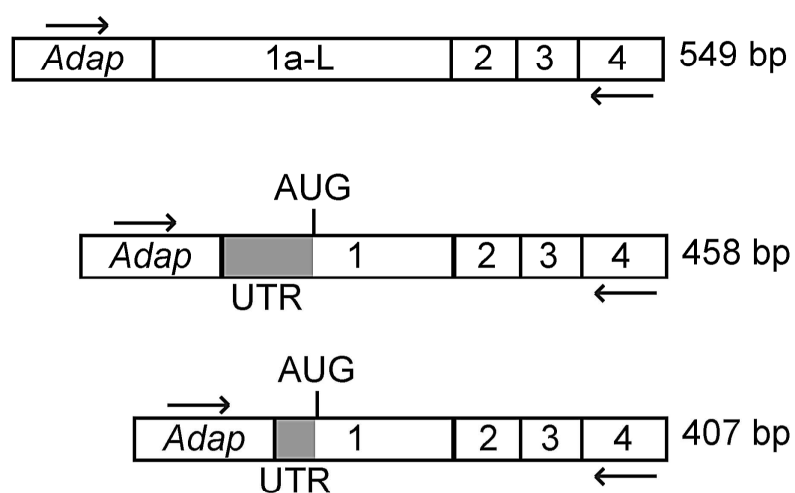
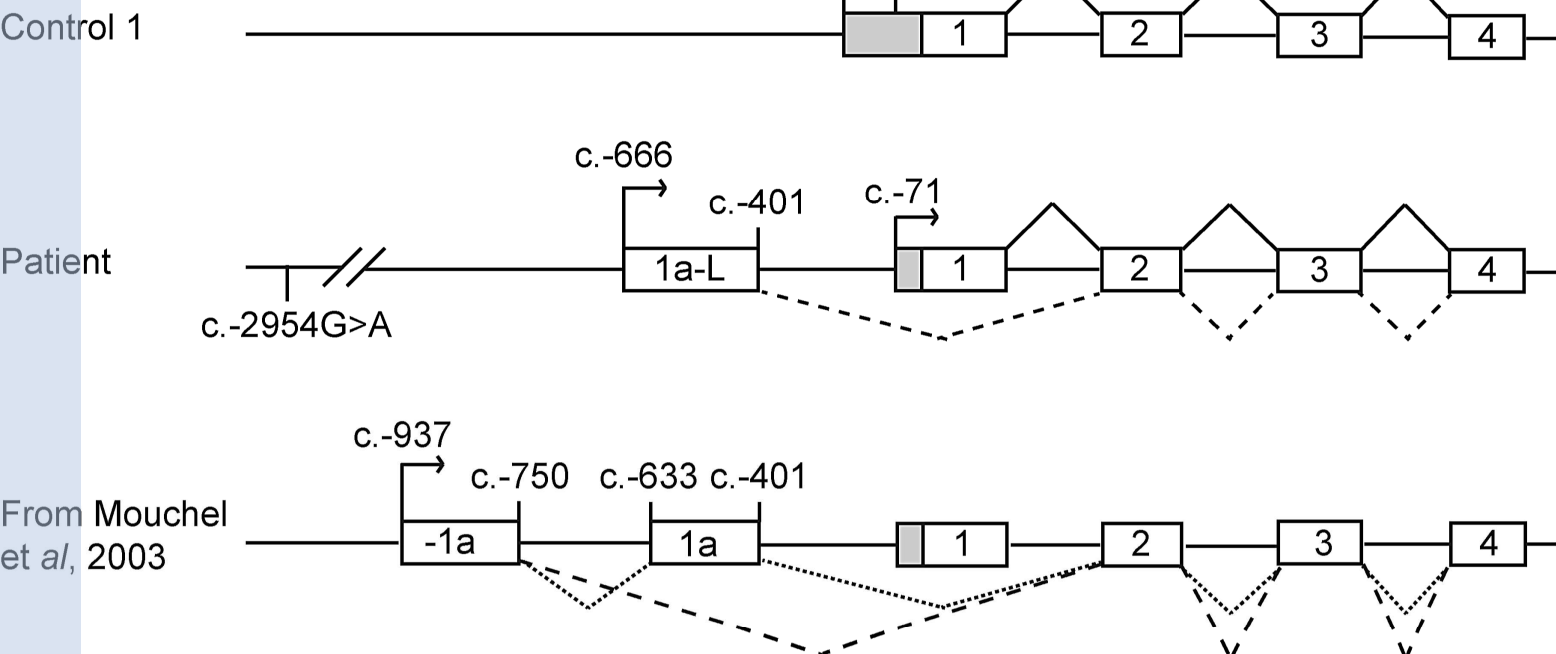
A**B****C****D****E**

A

Patient (upper)

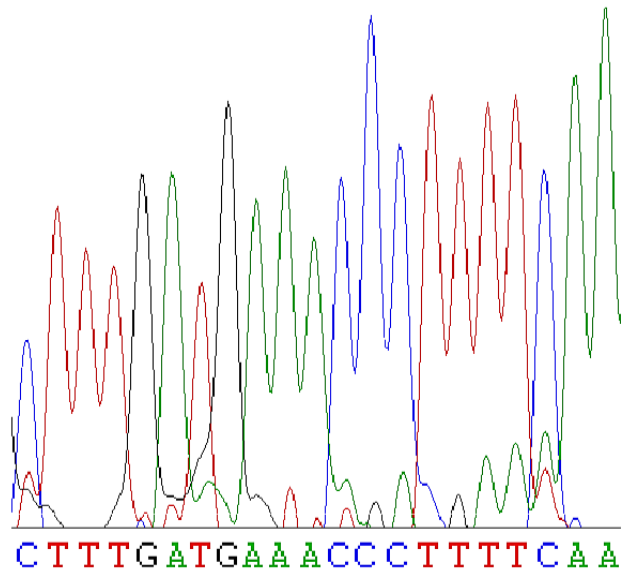

CTTTGATGAAACCCCTTTTCAA
5'RACE primer | exon 1a-L
(start site at c.-666)

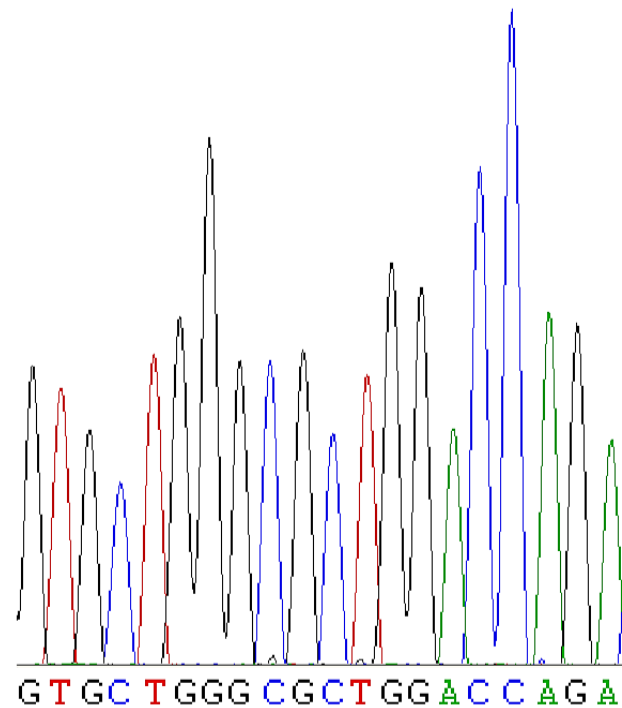

GTGC TGGGCGCTGGACCAGAA
exon 1a-L | exon 2

B

Patient (lower)

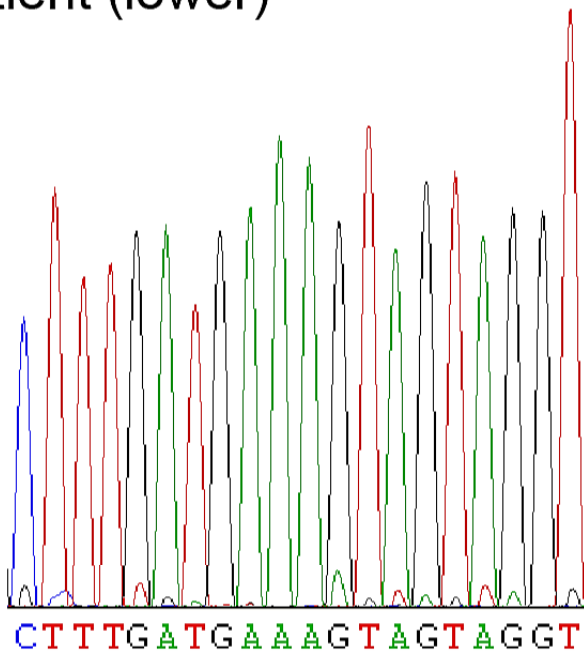

CTTTGATGAAAGTAGTAGGT
5'RACE primer | exon 1
(start site at c.-71)

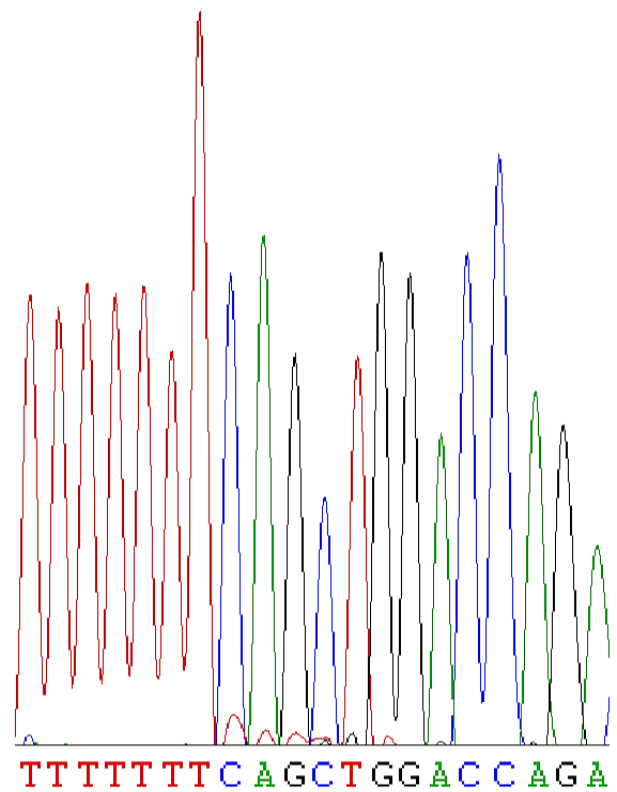

TTTTTTCAGCTGGACCAGAA
exon 1 | exon 2