



HAL
open science

Mutations that alter use of hepatitis C virus cell entry factors mediate escape from neutralizing antibodies.

Isabel Fofana, Samira Fafi-Kremer, Patric Carolla, Catherine Fauvelle, Muhammad Nauman Zahid, Marine Turek, Laura Heydmann, Karine Cury, Juliette Hayer, Christophe Combet, et al.

► To cite this version:

Isabel Fofana, Samira Fafi-Kremer, Patric Carolla, Catherine Fauvelle, Muhammad Nauman Zahid, et al.. Mutations that alter use of hepatitis C virus cell entry factors mediate escape from neutralizing antibodies.. *Gastroenterology*, 2012, 143 (1), pp.223-233.e9. 10.1053/j.gastro.2012.04.006 . inserm-00701511

HAL Id: inserm-00701511

<https://inserm.hal.science/inserm-00701511v1>

Submitted on 25 May 2012

HAL is a multi-disciplinary open access archive for the deposit and dissemination of scientific research documents, whether they are published or not. The documents may come from teaching and research institutions in France or abroad, or from public or private research centers.

L'archive ouverte pluridisciplinaire **HAL**, est destinée au dépôt et à la diffusion de documents scientifiques de niveau recherche, publiés ou non, émanant des établissements d'enseignement et de recherche français ou étrangers, des laboratoires publics ou privés.

Gastroenterology

Mutations that Alter Use of Hepatitis C Virus Cell Entry Factors Mediate Escape from Neutralizing Antibodies

--Manuscript Draft--

Manuscript Number:	GASTRO-D-11-01111R2
Full Title:	Mutations that Alter Use of Hepatitis C Virus Cell Entry Factors Mediate Escape from Neutralizing Antibodies
Article Type:	Basic - Liver/Pancreas/Biliary
Section/Category:	Human Research - Human Material
Corresponding Author:	Thomas F. Baumert, M. D. Inserm U748 Strasbourg, FRANCE
Corresponding Author Secondary Information:	
Corresponding Author's Institution:	Inserm U748
Corresponding Author's Secondary Institution:	
First Author:	Isabel Fofana
First Author Secondary Information:	
Order of Authors:	Isabel Fofana Samira Fafi-Kremer Patric Carolla Catherine Fauvelle Muhammad N Zahid Marine Turek Laura Heydmann Karine Cury Juliette Hayer Christophe Combet François-Loïc Cosset Thomas Pietschmann Marie-Sophie Hiet Ralf Bartenschlager François Habersetzer Michel Doffoël Zhen-Yong Keck Steven K.H. Foung Mirjam B Zeisel Françoise Stoll-Keller Thomas F. Baumert, M. D.
Order of Authors Secondary Information:	

Abstract:

Background & Aims: The development of vaccines and other strategies to prevent hepatitis C virus (HCV) infection is limited by rapid viral evasion. HCV entry is the first step of infection; this process involves several viral and host factors and is targeted by host neutralizing responses. Although the roles of host factors in HCV entry have been well characterized, their involvement in evasion of immune responses is poorly understood. We used acute infection of liver graft as a model to investigate the molecular mechanisms of viral evasion.

Methods: We studied factors that contribute to evasion of host immune responses using patient-derived antibodies, HCV pseudoparticles, and cell culture-derived HCV that express viral envelopes from patients who have undergone liver transplantation. These viruses were used to infect hepatoma cell lines that express different levels of HCV entry factors.

Results: Using reverse genetic analyses, we identified altered use of host-cell entry factors as a mechanism by which HCV evades host immune responses. Mutations that alter use of the CD81 receptor also allowed the virus to escape neutralizing antibodies. Kinetic studies demonstrated that these mutations affect virus-antibody interactions during post-binding steps of the HCV entry process. Functional studies with a large panel of patient-derived antibodies showed that this mechanism mediates viral escape, leading to persistent infection in general.

Conclusion: We identified a mechanism by which HCV evades host immune responses, in which use of cell entry factors evolves with escape from neutralizing antibodies. These findings advance our understanding of the pathogenesis of HCV infection and might be used to develop antiviral strategies and vaccines.

1 **Mutations that Alter Use of Hepatitis C Virus Cell Entry**
2 **Factors Mediate Escape from Neutralizing Antibodies**

3
4 **Molecular mechanisms of viral evasion in HCV infection**

5
6 Isabel Fofana^{1,2,*}, Samira Fafi-Kremer^{1,2,3,*}, Patric Carolla^{1,2,*}, Catherine Fauvelle^{1,2},
7 Muhammad Nauman Zahid^{1,2}, Marine Turek^{1,2}, Laura Heydmann^{1,2}, Karine Cury^{1,2},
8 Juliette Hayer⁴, Christophe Combet⁴, François-Loïc Cosset⁵, Thomas Pietschmann⁶,
9 Marie-Sophie Hiet⁷, Ralf Bartenschlager⁷, François Habersetzer^{1,2,8}, Michel
10 Doffoël^{1,2,8}, Zhen-Yong Keck⁹, Steven K.H. Fong⁹, Mirjam B. Zeisel^{1,2}, Françoise
11 Stoll-Keller^{1,2,3}, Thomas F. Baumert^{1,2,8,§}

12
13 ¹Inserm, U748, 67000 Strasbourg, France, ²Université de Strasbourg, 67000
14 Strasbourg, France, ³Laboratoire de Virologie, Hôpitaux Universitaires de Strasbourg,
15 67000 Strasbourg, France, ⁴Bases Moléculaires et Structurales des Systèmes
16 Infectieux, UMR 5086, CNRS, Université de Lyon, Institut de Biologie et Chimie des
17 Protéines, 69367 Lyon, France, ⁵Université de Lyon, Université Claude Bernard
18 Lyon1; IFR 128 ; Inserm, U758; Ecole Normale Supérieure de Lyon, 69364 Lyon,
19 France, ⁶Division of Experimental Virology, TWINCORE, Centre for Experimental and
20 Clinical Infection Research, a joint venture between the Medical School Hannover
21 and the Helmholtz Centre for Infection Research, 30625 Hannover, Germany, ⁷The
22 Department of Infectious Diseases, Molecular Virology, Heidelberg University, 69120
23 Heidelberg, Germany, ⁸Pôle Hepato-digestif, Hôpitaux Universitaires de Strasbourg,
24 67000 Strasbourg, France, ⁹Department of Pathology, Stanford University School of
25 Medicine, Stanford, 94304 California, USA

1 **Grant support:** This work was supported by Inserm, the European Union (ERC-
2 2008-AdG-233130-HEPCENT and Interreg IV FEDER-Hepato-Regio-Net 2009), the
3 ANR chair of excellence program (ANR-05-CEXC-008), ANRS (2007/306, 2008/354,
4 2009/183, 2011/132), the Région d'Alsace (2007/09), the Else Kröner-Fresenius
5 Stiftung (EKFS P17//07//A83/06), the Ligue Contre le Cancer (CA 06/12/08), INCA
6 (2009-143) and Canceropôle du Grand-Est (30/03/09), the Finovi Foundation, the
7 IBiSA GIS, the SFERE program and PHS grants HL079381 and AI081903.

8
9 **Acknowledgements:** The authors thank F. Chisari (The Scripps Research Institute,
10 La Jolla) for the gift of Huh7.5.1 cells, J. A. McKeating (University of Birmingham,
11 Birmingham, UK), C. Rice (Rockefeller University, New York City), C. Schuster
12 (Inserm U748, Strasbourg, France), M. Heim (University of Basel, Basel Switzerland),
13 F. Wong-Staal (Itherx, San Diego), J. Dubuisson (Inserm U1019, Lille, France) and F.
14 Rey (Institut Pasteur, Paris) for helpful discussions. We acknowledge excellent
15 technical assistance of Michèle Bastien-Valle (Inserm U748, Strasbourg, France).

16
17 **Abbreviations:** CLDN - claudin; CTRL - control; HCV - hepatitis C virus; HCVpp -
18 HCV pseudoparticles; HMAb - human monoclonal antibody; HVR - hypervariable
19 region; IgG - immune globulin G; mAb - monoclonal antibody; RLU - relative light
20 units; SR-BI - scavenger receptor class B type I; LT - liver transplantation; OCLN –
21 occludin ; V- viral variant.

22
23 **§Correspondence:** Thomas F. Baumert, M. D., Inserm Unit 748, Hôpitaux
24 Universitaires de Strasbourg, 3 rue Koeberlé, F-67000 Strasbourg, France; phone:
25 (33) 3 68 85 37 02; fax: (33) 3 68 85 37 50, e-mail: Thomas.Baumert@unistra.fr

26

1 **Disclosures:** This author discloses the following: T.P. is member of the advisory
2 board of Biotest AG and reports receiving consultancies. The remaining authors
3 disclose no conflicts.

4
5 **Author contribution:** I.F., S. F.-K and P.C. contributed equally to this work. S. F.-K,
6 M. B. Z., F. S.-K and T. F. B. designed and supervised research. I. F., S. F.-K, P. C,
7 C. F., M. N. Z., M. T., L. H., K. C., J. H., C. C., M.-S. H., F.-L. C, F. H., Z.-Y. K., S. K.
8 H. F, M. B. Z., F. S.-K and T. F. B. performed research. I. F., S. F.-K, P. C, C. F., M.
9 N. Z., M. T., M. B. Z., F. S.-K and T. F. B analyzed data. F.-L. C, T. P., R. B., F. H.,
10 M. D. F. S.-K provided reagents. I. F., S. F.-K, P. C, M. B. Z. and T. F. B. wrote the
11 paper.

12
13 Word count: title – 93 characters, abstract – 261 words, text – 5,993 words

14
15
16
17
18
19
20
21
22
23
24
25
26

ABSTRACT

Background & Aims: The development of vaccines and other strategies to prevent hepatitis C virus (HCV) infection is limited by rapid viral evasion. HCV entry is the first step of infection; this process involves several viral and host factors and is targeted by host neutralizing responses. Although the roles of host factors in HCV entry have been well characterized, their involvement in evasion of immune responses is poorly understood. We used acute infection of liver graft as a model to investigate the molecular mechanisms of viral evasion.

Methods: We studied factors that contribute to evasion of host immune responses using patient-derived antibodies, HCV pseudoparticles, and cell culture-derived HCV that express viral envelopes from patients who have undergone liver transplantation. These viruses were used to infect hepatoma cell lines that express different levels of HCV entry factors.

Results: Using reverse genetic analyses, we identified altered use of host-cell entry factors as a mechanism by which HCV evades host immune responses. Mutations that alter use of the CD81 receptor also allowed the virus to escape neutralizing antibodies. Kinetic studies demonstrated that these mutations affect virus–antibody interactions during post-binding steps of the HCV entry process. Functional studies with a large panel of patient-derived antibodies showed that this mechanism mediates viral escape, leading to persistent infection in general.

Conclusion: We identified a mechanism by which HCV evades host immune responses, in which use of cell entry factors evolves with escape from neutralizing antibodies. These findings advance our understanding of the pathogenesis of HCV infection and might be used to develop antiviral strategies and vaccines.

Keywords: virology; liver disease; tissue culture model; immunity

1 INTRODUCTION

2 Hepatitis C virus (HCV) infection is a major cause of liver disease.¹ A vaccine is not
3 available and antiviral treatment is limited by resistance and adverse effects.² HCV-
4 induced liver disease is a leading indication for liver transplantation (LT).³ A major
5 limitation of LT is the universal re-infection of the liver graft with accelerated
6 recurrence of liver disease. A strategy to prevent re-infection is lacking.³ Thus, there
7 is an urgent unmet medical need for the development of efficient and safe antivirals
8 and vaccines.

9 HCV entry is required for initiation, maintenance and dissemination of
10 infection. Viral entry is a key target for adaptive host responses and antiviral
11 strategies.^{4, 5} Functional studies in clinical cohorts highlight that viral entry and
12 escape from antibody-mediated neutralization play an important role in viral
13 persistence and liver disease.⁶⁻¹² HCV entry is a highly orchestrated process
14 mediated by viral envelope glycoproteins E1 and E2 and several host factors
15 including heparan sulfate, CD81, scavenger receptor BI (SR-BI), claudin-1 (CLDN1),
16 occludin (OCLN) (reviewed in ⁵) and kinases.¹³ While the role of E1E2 in antibody-
17 mediated neutralization has intensively been studied,^{4, 5, 14} the role of host factors for
18 viral evasion *in vivo* is only poorly understood.

19 Acute graft infection is an established *in vivo* model to study viral evasion
20 since viral infection and host neutralizing responses can be precisely monitored.⁸
21 Viral entry and escape from host neutralizing responses are important determinants
22 allowing the virus to rapidly infect the liver during transplantation.⁸ However, the
23 molecular mechanisms by which the virus evades host immunity to persistently re-
24 infect the liver graft are unknown.

25 To uncover viral and host factors mediating enhanced viral entry and escape,
26 we functionally analyzed genetically closely related prototype variants derived from a

1 well-characterized patient undergoing LT.⁸ One variant P01VL re-infecting the liver
2 graft was characterized by high infectivity and escape from neutralizing antibodies
3 present in autologous pre-transplant serum.⁸ The other closely related variants,
4 P01VA and VC, were not selected during LT and characterized by lower infectivity
5 and high sensitivity to neutralization by autologous pre-transplant serum.⁸ Previous
6 studies had indicated that an E2 region comprising amino acids 425-483 most likely
7 contained mutations responsible for the phenotype of enhanced entry and viral
8 evasion of variants re-infecting the liver graft.⁸

9

10

MATERIALS AND METHODS

1
2 **Patients.** Evolution and functional analysis of viral variants of patient P01 have been
3 described.⁸ Anti-HCV-positive serum samples from patients undergoing
4 transplantation and chronic HCV infection were obtained with approval from the
5 Strasbourg University Hospital IRB (ClinicalTrial.gov Identifiers NCT00638144 and
6 NCT00213707).

7
8 **Plasmids.** Plasmids for HCVpp production of variants VL, VA and VC have been
9 described.⁸ E1E2-encoding sequences were used as templates for individual and
10 combinations of mutations using the QuikChange II XL site-directed mutagenesis kit
11 (Stratagene). Mutations were confirmed by DNA sequence analysis (GATC Biotech)
12 for the desired mutation and for exclusion of unexpected residue changes in the full-
13 length E1E2 encoding sequences. Mutated constructs were designated X#Y, where
14 # is the residue location in H77c,¹⁵ X is the mutated and Y the original amino acid.

15
16 **Antibodies.** Monoclonal anti-E1 (11B7) and anti-E2 (AP33, IGH461, 16A6), human
17 anti-HCV IgG,^{10, 16} HMAbs CBH-2, CBH-5, CBH-23 and HC-1 have been described.^{9,}
18 ¹⁷ Anti-CD81 (JS-81) was from BD Biosciences, AP33 from Genentech, 11B7,
19 IGH461 and 16A6 from Innogenetics.

20
21 **Cell lines.** HEK 293T and Huh7.5.1 cells were cultured as described.^{10, 13, 16}
22 Huh7.5.1 cells overexpressing HCV entry factors were created by stable lentiviral
23 gene transfer of CLDN1, OCLN, SR-BI or CD81.¹⁸ Huh7.5 stably transduced with
24 retroviral vectors encoding for CD81 and CD13-specific shRNAs have been
25 described.¹⁹ Receptor expression was assessed by flow cytometry .¹³

1 **HCVpp and HCVcc production, infection and neutralization.** Lentiviral HCVpp
2 bearing patient-derived envelope glycoproteins were produced as described.^{8, 10, 20}
3 The amount of HCVpp was normalized following quantification of HIV p24 antigen
4 expression (Innotest HIV Antigen mAb Kit, Innogenetics) and HCVpp entry was
5 performed as described.^{8, 10, 11, 16} Chimeric HCVcc expressing patient-derived
6 structural proteins were constructed and produced as described in Supplementary
7 Materials and Methods. HCVcc infectivity was determined by determining the
8 TCID₅₀²¹ or intracellular HCV RNA levels as described.^{13, 21, 22} HCVpp and HCVcc
9 neutralization were performed as described.^{8, 10, 11, 16}

10

11 **Kinetic assays.** HCVpp kinetic assays were performed in Huh7.5.1 cells using anti-
12 CD81 (JS-81) and anti-E2 (CBH-23) mAbs as described.^{16, 23}

13

14 **Statistical analysis.** Statistical analysis (Repeated Measures ANOVA) was
15 performed using the SPSS 16.0 software for Windows (SPSS Inc., Chicago, IL).

16

17

RESULTS

1
2 **HCV E2 residues at positions 447, 458 and 478 confer enhanced viral entry of a**
3 **high-infectivity variant re-infecting the liver graft.** To investigate the molecular
4 mechanism of enhanced entry of the variant VL re-infecting the liver graft, we first
5 introduced individual mutations of region E2₄₂₅₋₄₈₃⁸ of the low-entry and
6 neutralization-sensitive mutant VC into HCV pseudoparticles (HCVpp) expressing
7 envelope glycoproteins of the highly infectious escape variant VL (Fig. 1A). Previous
8 studies had indicated that this region most likely contains the mutations responsible
9 for the high-infectivity phenotype of VL.⁸ Following normalization of HCVpp levels by
10 p24 antigen expression, viral entry was quantified relative to the escape variant VL.
11 The entry level of the nonselected variant VC was 5% compared to the escape
12 variant VL (Fig. 1B). By introducing the mutations S458G and R478C into VC,
13 chimeric HCVpp showed similar viral entry level as the paternal variant VL whereas
14 introduction of individual or combination of other mutations only had a partial effect
15 (Fig. 1B, Fig. S1). To explore the impact of other positions on viral entry we
16 introduced mutations from another nonselected variant termed VA into VL (Fig. 1A)
17 and identified position F447 as an additional residue relevant for enhanced entry of
18 the escape variant VL (Fig. 1C). These results demonstrate that residues F447L,
19 S458G and R478C are largely responsible for the high-infectivity of the escape
20 variant VL.

21
22 **Enhanced viral entry by mutations F447L, S458G and R478C of the escape**
23 **variant is the result of altered use of CD81.** To address whether the mutations
24 affect viral entry by different usage of cell entry factors SR-BI, CD81, CLDN1 and
25 OCLN, we studied viral entry of HCVpp derived from parental and chimeric variants
26 in Huh7.5.1 cells stably overexpressing individually the four main entry factors (Fig.

1 2A). Overexpression of either SR-BI, CD81, CLDN1 or OCLN, did not affect the
2 stability or proportion of other cell surface HCV receptors (Fig. 2B and data not
3 shown).

4 Overexpression of CD81 significantly enhanced viral entry of VL (3.2fold) and
5 VC (2fold) compared to parental cells ($P < .001$) (Fig. 2C). The fold change in HCVpp
6 entry was significantly higher for VL than for VC ($P < .001$). Exchanging the two
7 residues at position 458 and 478 similarly increased viral entry. This suggests that
8 combination of the two individual mutations modulates viral entry by altering CD81-
9 dependency. Overexpression of SR-BI also increased viral entry of VL and VC, but
10 no specific increase was observed for the chimeric strains containing substitutions at
11 positions 458 and 478 (Fig. 2C). These data confirm an important role for SR-BI as
12 an entry factor for patient-derived variants, but also demonstrate that positions 458
13 and 478 do not significantly alter SR-BI-dependency. Thus, increased entry efficiency
14 of VL in SR-BI-overexpressing cells is most likely due to other mutations, e. g. in
15 HVR1. Viral entry enhancement was less pronounced in cells overexpressing CLDN1
16 or OCLN than CD81 and SR-BI (Fig. 2C) and no specific modulation of viral entry
17 was associated with the two variants or chimeric strains.

18 The CD81 usage of viral variants VL, VC and VA was further investigated
19 using Huh7.5 cells with silenced CD81 expression (Fig. 3A).¹⁹ The escape variant VL
20 showed the highest decrease (5.4fold) of viral entry in shCD81-Huh7.5 cells
21 compared to the decrease of variants VC (4.3fold, $P < .001$) and VA (2.9fold, $P <$
22 $.001$) (Fig. 3B-C). Exchange of the mapped residues into chimeric expression
23 plasmids conferred the phenotype of decreased entry of VL (Fig. 3B-C) confirming
24 that identified residues modulate viral entry by different CD81 usage. Moreover,
25 using a relevant model system for HCV-CD81 interactions occurring *in vivo*
26 consisting of cell surface-expressed CD81, we demonstrate that E1E2 complexes of

1 the escape variant VL bound less efficiently to shCD81-Huh7.5 cells than
2 glycoproteins of variants VC and VA (Fig. S2A). Exchange of the mapped residues
3 conferred similar phenotypes as the parental glycoproteins (Fig. S2B) suggesting that
4 the residues at positions 447, 458 and 478 alter E1E2 interactions with cell surface
5 CD81.

6 Taken together, these data demonstrate that (i) the escape variant is
7 characterized by markedly altered CD81 usage and (ii) altered CD81 usage of the
8 variant is mediated by residues at positions 447, 458 and 478.

9 Since the levels of E1E2 incorporation into HCVpp and lentiviral p24 antigen
10 expression were similar for all strains (Fig. S3A-D), it is unlikely that the differences in
11 viral entry are the result of impaired HCVpp assembly or release.

12 Next, to assess whether enhanced entry is due to more rapid internalization of
13 viral particles we investigated internalization kinetics of the parental and chimeric
14 variants in the presence of anti-CD81 antibody.^{16, 21, 23, 24} Since entry kinetics of
15 parental and chimeric variants were similar (Fig. 3D), it is unlikely that the mutant-
16 induced modulation of CD81-dependency alters the velocity of viral entry.

17

18 **Positions 447, 458 and 478 mediate escape from autologous transplant serum**
19 **during graft re-infection.** To assess whether the residues in region E2₄₂₅₋₄₈₃
20 influencing viral entry (Fig. 1) were also responsible for escape from antibody-
21 mediated neutralization, we studied the impact of each single and combined
22 substitutions of the nonselected variant VC on neutralization by autologous pre-
23 transplant serum. Autologous pre-transplant serum only poorly neutralized the
24 selected variant VL as well as the variants substituted at position 434, 444, and 445
25 while individual substitution at positions 458 and 478 significantly ($P < .001$, $P \leq .05$)
26 increased the sensitivity of VLVC₄₅₈ and VLVC₄₇₈ to autologous neutralizing

1 antibodies (1:400 and 1:200) (Fig. 4A). Noteworthy, only the variant VLVC₄₅₈₊₄₇₈
2 showed a similar neutralization titer as the nonselected variant VC (1:6,400, $P <$
3 .001). To confirm that these mutations were indeed responsible for the phenotype of
4 the parental variant VL, we investigated neutralization of VCVL₄₅₈₊₄₇₈ by autologous
5 serum. The variant VCVL₄₅₈₊₄₇₈ escaped autologous neutralization similarly to the
6 escape variant VL (Fig. 4A). A similar phenotype was observed when mutation 447 of
7 VA was introduced into the VL cDNA (Fig. 4B). In contrast, the introduction of other
8 residues into VL only had a minor effect on neutralization (Fig. 4B). Taken together,
9 these findings suggest that the residues at positions 447, 458 and 478 are
10 simultaneously responsible for both enhanced viral entry and evasion from antibody-
11 mediated neutralization.

12

13 **Positions 447, 458 and 478 define a conformational epitope involved in evasion**
14 **from host neutralizing responses.** To further elucidate the mechanism of viral
15 evasion of the escape variant VL from patient-derived neutralizing antibodies, we
16 investigated whether the identified mutations F447L, S458G and R478C confer
17 resistance or sensitivity to a panel of mAbs directed against conformational^{9, 17} and
18 linear E2 epitopes.¹⁶ The conformational HMAs (CBH-2, CBH-5, CBH-23, HC-1)
19 have been shown to exhibit a broad cross-neutralizing activity by interfering with E2-
20 CD81 interaction^{9, 17} and their epitopes are only partially defined (Table S1). AP33 is
21 directed against a conserved epitope comprising aa 412-423.²⁵ While the escape
22 variant VL was poorly neutralized by several HMAs directed against conformational
23 epitopes, VC and VA were efficiently neutralized by all HMAs (Fig. 5A-B). Moreover,
24 by substituting the residues at positions 458 and 478 or 447, the well neutralized
25 nonselected variants VC (VCVL₄₅₈₊₄₇₈) and VA (VAVL₄₄₇) became neutralization-
26 resistant as the escape variant VL. Introducing the residues of VC or VA into VL

1 (VLVC₄₅₈₊₄₇₈ and VLVA₄₄₇) restored neutralization by HMABs, suggesting that these
2 residues are part of the HMABs epitopes. In contrast, anti-E2 antibodies (AP33,
3 16A6, IGH461) targeting linear epitopes similarly neutralized parental and chimeric
4 variants (Fig. 5A-B and Table S1).

5 Antibody-mediated neutralization occurs at binding and post-binding steps
6 during viral entry.¹⁶ To map the entry step involved in viral evasion from neutralizing
7 antibodies by VL, we investigated the neutralization kinetics of parental and chimeric
8 variants.^{16, 21, 23} The anti-E2 HMAb CBH-23 inhibited viral entry of VC and
9 VLVC₄₅₈₊₄₇₈ at post-binding steps during time points closely related to HCV-CD81
10 interaction (Fig. 5C). Partial inhibition at post-binding steps by CBH-23 was also
11 observed for VA and VLVA₄₄₇ (Fig. 5D). The VL variant escaped antibody-mediated
12 neutralization at the same steps.

13 Interestingly, purified HCVpp expressing envelope glycoproteins of the escape
14 variant bound similarly to neutralizing anti-E2 antibody CBH-23 as the envelope
15 glycoproteins of non selected variants or variants containing mutations of the
16 identified escape residue (Fig. S4). Thus, it is likely that viral evasion is not due to
17 decreased antibody-binding to circulating virions but rather occurs during post-
18 binding steps of viral entry where E2-host entry factor interactions result in
19 conformational changes of the envelope and failure of antibodies to inhibit entry.
20 Taken together, these data indicate that positions 447, 458 and 478 mediate viral
21 evasion from neutralizing antibodies at post-binding steps and time points closely
22 related to HCV-CD81 interaction.

23

24 **Positions 447, 458 and 478 mediate escape from antiviral antibodies in non-**
25 **related patients with chronic HCV infection.** To investigate whether these
26 mutations not only result in escape from antibodies from the same patient but also

1 confer resistance to antiviral antibodies of non-related HCV infected patients, we
2 studied the neutralization of the parental variants by a large panel of sera randomly
3 selected from chronically infected patients ($n = 102$). While VL was not neutralized by
4 53 out of 102 patient sera (mean neutralizing titer, 1:144) VC was significantly
5 neutralized by 90 out of 102 patient sera (mean neutralizing titer, 1:1,088, $P < .001$)
6 (Fig. 6 and Table S2). Similar results were obtained for VA (neutralization by 80 out
7 of 102 patient sera, mean neutralizing titer of 1:322, $P = .01$). Functional analysis of
8 HCVpp expressing chimeric envelope glycoproteins demonstrated that neutralization
9 of VC and VA was predominantly mediated by the identified mutations in residues
10 447, 458 and 478 (Fig. 6).

11
12 **Confirmation of differential cell entry factor usage and viral evasion using**
13 **chimeric HCVcc.** Finally, we confirmed the functional impact of the three residues
14 on virus-host interactions using the HCVcc system. To address this issue we
15 constructed chimeric JFH-1 based HCVcc expressing the VL wild-type envelope or
16 VL containing VC and VA-specific functional residues. Viruses containing patient-
17 derived envelopes showed similar levels of replication and envelope production (data
18 not shown). Phenotypic analyses of infection and neutralization of chimeric HCVcc
19 confirmed the relevance of the identified residues for enhanced entry, differential
20 CD81 usage and viral evasion (Fig. 7A-D). While the escape variant VL was poorly
21 neutralized, the identified mutations at positions 447, 458 and 478 restored its
22 sensitivity to conformational HMAb CBH-23 (Fig. 7C) as well as to heterologous sera
23 from chronically infected patients (Fig. 7D). These data confirm the functional
24 relevance of the obtained results in the HCVcc system expressing authentic patient-
25 derived envelopes.

26

1 DISCUSSION

2 Using acute infection of the liver graft as an *in vivo* model, we identified a novel,
3 clinically and therapeutically important mechanism of viral evasion, where co-
4 evolution simultaneously occurs between cellular entry factor usage and escape from
5 neutralization.

6 Several host selection forces operate concomitantly during HCV infection.
7 These include pro-viral host factors resulting in selection of most infectious viruses
8 best adapted to host factors and anti-viral host immune responses leading to escape
9 from immune responses. Antibody-mediated selective pressure is thought to be an
10 important driver of viral evolution.^{8, 11} The immune response may fail to resolve HCV
11 infection because neutralizing antibody-mediated response lags behind the rapidly
12 and continuously evolving HCV glycoprotein sequences.¹¹ However, continuous
13 generation of escape mutations during chronic HCV infection may also compromise
14 virus infectivity: indeed, it has been reported that structural changes in E2 leading to
15 complete escape from neutralizing antibodies simultaneously compromised viral
16 fitness by reducing CD81-binding.⁹ Moreover, escape from T cell responses has
17 been associated with impaired viral replication.^{26, 27} We show for the first time that
18 clinically occurring mutations simultaneously lead to enhanced viral infectivity by
19 optimizing host factor usage and escape from host immune responses. Since this
20 mechanism was uncovered in patient strains isolated during acute liver graft infection
21 it is likely that the novel and unique mechanism of co-evolution between host factor
22 usage and viral evasion ensures optimal initiation, dissemination and maintenance of
23 viral infection in the early phase of liver graft infection. In addition, since the VL strain
24 escapes autologous antibodies from the transplant patient (Fig. 4) and resists to
25 monoclonal and polyclonal antibodies of heterologous patients (Figs. 5, 6, 7 and
26 Tables S1, S2), and given the high prevalence of the identified mutations in a large

1 genomic database of viral isolates (Fig. S5 and Supplementary Results), the co-
2 evolution of receptor usage and escape from neutralizing antibodies may also play
3 an important role for viral evasion in chronic HCV infection in general.

4 Our mechanistic studies demonstrate that the identified viral evasion factors
5 are part of a conformational neutralizing epitope modulating E2-CD81 interactions at
6 post-binding entry steps.^{28, 29} Noteworthy, the same mutations were also responsible
7 for immune escape of VL. Neutralization studies using HMAbs directed against
8 discontinuous envelope glycoprotein regions termed domain B and C^{30, 31}
9 demonstrate that the three positions are part of an epitope which plays a key role for
10 neutralization and viral evasion. Since the mutations are outside the known contact
11 residues within the epitopes of the HMAbs CBH-2, CBH-5, CBH-23 and HC-1^{9, 17}
12 (Table S1) and complementary to previously identified regions associated with
13 escape from neutralizing monoclonal antibodies,²⁵ positions 447, 458 and 478 either
14 modulate the interaction of the majority of antibodies directed against domain B and
15 C epitopes or are part of a novel E2 epitope mediating evasion from host neutralizing
16 antibodies.

17 Based on previous functional observations and structural predictions, Krey and
18 colleagues proposed a model for a potential tertiary organisation of E2. In this model,
19 E2 comprises three subdomains with the CD81 binding regions located within
20 domain I (W420, A440LFY, Y527, W529, G530 and D535) and potential CD81
21 binding sites overlapping with domain III (Y613RLWHY).^{28, 29, 32, 33} In this model,
22 positions 447, 458 and 478 are located outside but in close proximity of the
23 previously suggested CD81 binding domains. Moreover, position 447 is located
24 immediately downstream a conserved motif between HVR1 and HVR2 which has
25 been shown to play an important role in CD81 recognition as well as pre- or post-

1 CD81 dependent stages of viral entry.³² Position 478 is located within HVR2 which
2 modulates, by a complex interplay with HVR1, binding of E2 glycoprotein to CD81.³⁴

3 Since mutations F447L, S458G and R478C (i) modulate CD81-dependency of
4 HCV entry (Fig. 2 and 3), (ii) alter the interaction with cell surface CD81 (Fig. S2), (iii)
5 mediate viral evasion from antibodies at post-binding steps closely related to HCV-
6 CD81 interactions (Fig. 5) and (iv) are located within E2 loops of the predicted E2
7 secondary structure and tertiary organization²⁹ positions 447, 458 and 478 may be
8 part of two loops belonging to a larger cluster of closely related surface-exposed E2
9 loops. These loops are most likely involved in E2-CD81 binding either directly or
10 indirectly as a key point for structural rearrangement during viral entry.^{34, 35}

11 The polar S and R residues present in the escape variant can form non-
12 bonded interactions with other residues by hydrogen bonds and salt bridge,
13 respectively. These interactions could increase the stability of the interacting E2-
14 CD81 interface allowing efficient entry of the VL escape variant through E2-CD81-
15 CLDN1 co-receptor complexes which are key determinants for viral entry.^{13, 23, 36}
16 Furthermore, the E2 cluster of loops containing the mutations bears linear epitopes
17 but also defines at least one conformational epitope that is a target of neutralizing
18 antibodies. According to residue physical-chemical properties, the VL variant S458
19 and R478 residues enhance the hydrophilicity of the loops they belong to and may
20 promote the surface exposure of the loops. This change could further modulate E2-
21 CD81 interactions and impair the binding of neutralizing antibodies by blocking
22 access to their target epitopes. The F to L substitution present in the VA strain most
23 likely does not profoundly alter the tertiary or quaternary structure of E2. This is
24 suggested by the fact that this position is located in a loop as predicted by the
25 proposed E2 model.²⁹ Thus, it is conceivable that this mutation which increases E2
26 hydrophobicity may reduce accessibility of the loop and its interactions with CD81 or

1 CD81-CLDN1 co-receptor complexes. Alternatively, allosteric mechanisms may play
2 a role in the observed virus-antibody-host interactions.

3 Taken together, our data identified key determinants of immune evasion *in*
4 *vivo*. Mutations conferring neutralization escape altered CD81 receptor usage and
5 enhanced cell entry. Moreover, our data suggest that mutations in HVR1 which may
6 modulate entry and neutralization by altering SR-BI-dependency (Fig. 1, 2, 4 and
7 data not shown) may contribute to the high-entry and escape phenotype of the
8 escape variant. Furthermore, interfering non-neutralizing antibodies may constitute
9 another mechanism of escape (data not shown).

10 Although proof-of-concept studies in animal models have demonstrated a
11 potential role for HMABs in prevention of HCV infection,^{37, 38} the partial or complete
12 escape of the VL variant from autologous and heterologous serum-derived antibodies
13 as well as many broadly cross-neutralizing HMABs (Fig. 5; Table S1) demonstrates
14 the ability of the virus to evade cross-neutralizing anti-envelope mAbs. By identifying
15 viral and host factors mediating immune evasion in the HCV-infected patient, our
16 results may open new perspectives for the development of broadly cross-neutralizing
17 anti-envelope or anti-receptor antibodies overcoming viral escape.

18

19

20

21

22

23

24

REFERENCES

- 1
- 2 1. Alter H. Viral hepatitis. *Hepatology* 2006;43:S230-4.
- 3 2. Hofmann WP, Zeuzem S. A new standard of care for the treatment of chronic
4 HCV infection. *Nat Rev Gastroenterol Hepatol* 2011;8:257-64.
- 5 3. Watt K, Veldt B, Charlton M. A practical guide to the management of HCV
6 infection following liver transplantation. *Am J Transplant* 2009;9:1707-13.
- 7 4. Zeisel MB, Cosset FL, Baumert TF. Host neutralizing responses and
8 pathogenesis of hepatitis C virus infection. *Hepatology* 2008;48:299-307.
- 9 5. Zeisel MB, Fofana I, Fafi-Kremer S, Baumert TF. HCV entry into hepatocytes:
10 mechanism and potential therapeutic implications. *J Hepatol* 2011;54:566-576.
- 11 6. Lavillette D, Morice Y, Germanidis G, Donot P, Soulier A, Pagkalos E,
12 Sakellariou G, Intrator L, Bartosch B, Pawlotsky JM, Cosset FL. Human serum
13 facilitates hepatitis C virus infection, and neutralizing responses inversely
14 correlate with viral replication kinetics at the acute phase of hepatitis C virus
15 infection. *J Virol* 2005;79:6023-34.
- 16 7. Dowd KA, Netski DM, Wang XH, Cox AL, Ray SC. Selection Pressure From
17 Neutralizing Antibodies Drives Sequence Evolution During Acute Infection
18 With Hepatitis C Virus. *Gastroenterology* 2009;136:2377-86.
- 19 8. Fafi-Kremer S, Fofana I, Soulier E, Carolla P, Meuleman P, Leroux-Roels G,
20 Patel AH, Cosset F-L, Pessaux P, Doffoël M, Wolf P, Stoll-Keller F, Baumert
21 TF. Enhanced viral entry and escape from antibody-mediated neutralization
22 are key determinants for hepatitis C virus re-infection in liver transplantation. *J*
23 *Exp Med* 2010;207:2019-2031.
- 24 9. Keck ZY, Li SH, Xia J, von Hahn T, Balfe P, McKeating JA, Witteveldt J, Patel
25 AH, Alter H, Rice CM, Fong SK. Mutations in hepatitis C virus E2 located

- 1 outside the CD81 binding sites lead to escape from broadly neutralizing
2 antibodies but compromise virus infectivity. *J Virol* 2009;83:6149-60.
- 3 10. Pestka JM, Zeisel MB, Blaser E, Schurmann P, Bartosch B, Cosset FL, Patel
4 AH, Meisel H, Baumert J, Viazov S, Rispeter K, Blum HE, Roggendorf M,
5 Baumert TF. Rapid induction of virus-neutralizing antibodies and viral
6 clearance in a single-source outbreak of hepatitis C. *Proc Natl Acad Sci U S A*
7 2007;104:6025-30.
- 8 11. von Hahn T, Yoon JC, Alter H, Rice CM, Rehermann B, Balfe P, McKeating
9 JA. Hepatitis C virus continuously escapes from neutralizing antibody and T-
10 cell responses during chronic infection in vivo. *Gastroenterology*
11 2007;132:667-78.
- 12 12. Osburn WO, Fisher BE, Dowd KA, Urban G, Liu L, Ray SC, Thomas DL, Cox
13 AL. Spontaneous control of primary hepatitis C virus infection and immunity
14 against persistent reinfection. *Gastroenterology* 2010;138:315-24.
- 15 13. Lupberger J, Zeisel MB, Xiao F, Thumann C, Fofana I, Zona L, Davis C, Mee
16 CJ, Turek M, Gorke S, Royer C, B. F, Zahid MN, Lavillette D, J. F, Cosset F-L,
17 Rothenberg SM, Pietschmann T, Patel AH, Pessaux P, Doffoël M,
18 Raffelsberger W, Poch O, McKeating JA, Brino L, Baumert TF. EGFR and
19 EphA2 are hepatitis C virus host entry factors and targets for antiviral therapy.
20 *Nat Med* 2011;17:589-95.
- 21 14. Stamatakis Z, Grove J, Balfe P, McKeating JA. Hepatitis C virus entry and
22 neutralization. *Clin Liver Dis* 2008;12:693-712.
- 23 15. Kuiken C, Combet C, Bukh J, Shin IT, Deleage G, Mizokami M, Richardson R,
24 Sablon E, Yusim K, Pawlotsky JM, Simmonds P. A comprehensive system for
25 consistent numbering of HCV sequences, proteins and epitopes. *Hepatology*
26 2006;44:1355-61.

- 1 16. Haberstroh A, Schnober EK, Zeisel MB, Carolla P, Barth H, Blum HE, Cosset
2 FL, Koutsoudakis G, Bartenschlager R, Union A, Depla E, Owsianka A, Patel
3 AH, Schuster C, Stoll-Keller F, Doffoel M, Dreux M, Baumert TF. Neutralizing
4 host responses in hepatitis C virus infection target viral entry at postbinding
5 steps and membrane fusion. *Gastroenterology* 2008;135:1719-1728.
- 6 17. Hadlock KG, Lanford RE, Perkins S, Rowe J, Yang Q, Levy S, Pileri P,
7 Abrignani S, Fong SK. Human monoclonal antibodies that inhibit binding of
8 hepatitis C virus E2 protein to CD81 and recognize conserved conformational
9 epitopes. *J Virol* 2000;74:10407-16.
- 10 18. Haid S, Windisch MP, Bartenschlager R, Pietschmann T. Mouse-specific
11 residues of claudin-1 limit hepatitis C virus genotype 2a infection in a human
12 hepatocyte cell line. *J Virol* 2009;84:964-75.
- 13 19. Koutsoudakis G, Herrmann E, Kallis S, Bartenschlager R, Pietschmann T. The
14 level of CD81 cell surface expression is a key determinant for productive entry
15 of Hepatitis C Virus into host cells. *J Virol* 2007;81:588-598.
- 16 20. Bartosch B, Dubuisson J, Cosset FL. Infectious hepatitis C virus pseudo-
17 particles containing functional E1-E2 envelope protein complexes. *J. Exp.*
18 *Med.* 2003;197:633-42.
- 19 21. Zeisel MB, Koutsoudakis G, Schnober EK, Haberstroh A, Blum HE, Cosset F-
20 L, Wakita T, Jaek D, Doffoel M, Royer C, Soulier E, Schvoerer E, Schuster C,
21 Stoll-Keller F, Bartenschlager R, Pietschmann T, Barth H, Baumert TF.
22 Scavenger receptor BI is a key host factor for Hepatitis C virus infection
23 required for an entry step closely linked to CD81. *Hepatology* 2007; 46:1722-
24 1731.
- 25 22. Fofana I, Krieger SE, Grunert F, Glauben S, Xiao F, Fafi-Kremer S, Soulier E,
26 Mee CJ, McKeating JA, Dragic T, Schuster C, Thompson J, Baumert TF.

- 1 Monoclonal anti-claudin 1 antibodies for prevention of hepatitis C virus
2 infection. *Gastroenterology* 2010;139:953-964, 964.e1-4.
- 3 23. Krieger SE, Zeisel MB, Davis C, Thumann C, Harris HJ, Schnober EK, Mee C,
4 Soulier E, Royer C, Lambotin M, Grunert F, Dao Thi VL, Dreux M, Cosset FL,
5 McKeating JA, Schuster C, Baumert TF. Inhibition of hepatitis C virus infection
6 by anti-claudin-1 antibodies is mediated by neutralization of E2-CD81-claudin-
7 1 associations. *Hepatology* 2010;51:1144-57.
- 8 24. Koutsoudakis G, Kaul A, Steinmann E, Kallis S, Lohmann V, Pietschmann T,
9 Bartenschlager R. Characterization of the early steps of hepatitis C virus
10 infection by using luciferase reporter viruses. *J Virol* 2006;80:5308-20.
- 11 25. Owsianka A, Tarr AW, Juttla VS, Lavillette D, Bartosch B, Cosset FL, Ball JK,
12 Patel AH. Monoclonal antibody AP33 defines a broadly neutralizing epitope on
13 the hepatitis C virus E2 envelope glycoprotein. *J Virol* 2005;79:11095-104.
- 14 26. Dazert E, Neumann-Haefelin C, Bressanelli S, Fitzmaurice K, Kort J, Timm J,
15 McKiernan S, Kelleher D, Gruener N, Tavis JE, Rosen HR, Shaw J, Bowness
16 P, Blum HE, Klenerman P, Bartenschlager R, Thimme R. Loss of viral fitness
17 and cross-recognition by CD8+ T cells limit HCV escape from a protective
18 HLA-B27-restricted human immune response. *J Clin Invest* 2009;119:376-86.
- 19 27. Uebelhoer L, Han JH, Callendret B, Mateu G, Shoukry NH, Hanson HL, Rice
20 CM, Walker CM, Grakoui A. Stable cytotoxic T cell escape mutation in
21 hepatitis C virus is linked to maintenance of viral fitness. *PLoS Pathog*
22 2008;4:e1000143.
- 23 28. Owsianka AM, Timms JM, Tarr AW, Brown RJ, Hickling TP, Szwejk A,
24 Bienkowska-Szewczyk K, Thomson BJ, Patel AH, Ball JK. Identification of
25 conserved residues in the E2 envelope glycoprotein of the hepatitis C virus
26 that are critical for CD81 binding. *J Virol* 2006;80:8695-704.

- 1 29. Krey T, d'Alayer J, Kikuti CM, Saulnier A, Damier-Piolle L, Petitpas I,
2 Johansson DX, Tawar RG, Baron B, Robert B, England P, Persson MA,
3 Martin A, Rey FA. The disulfide bonds in glycoprotein E2 of hepatitis C virus
4 reveal the tertiary organization of the molecule. PLoS Pathog
5 2010;6:e1000762.
- 6 30. Keck ZY, Op De Beeck A, Hadlock KG, Xia J, Li TK, Dubuisson J, Fong SK.
7 Hepatitis C virus E2 has three immunogenic domains containing
8 conformational epitopes with distinct properties and biological functions. J
9 Virol 2004;78:9224-32.
- 10 31. Helle F, Goffard A, Morel V, Duverlie G, McKeating J, Keck ZY, Fong S,
11 Penin F, Dubuisson J, Voisset C. The neutralizing activity of anti-hepatitis C
12 virus antibodies is modulated by specific glycans on the E2 envelope protein.
13 J Virol 2007;81:8101-11.
- 14 32. Drummer HE, Boo I, Maerz AL, Pountourios P. A Conserved Gly436-Trp-
15 Leu-Ala-Gly-Leu-Phe-Tyr Motif in Hepatitis C Virus Glycoprotein E2 Is a
16 Determinant of CD81 Binding and Viral Entry. J Virol 2006;80:7844-7853.
- 17 33. Boo I, Tewierek K, Douam F, Lavillette D, Pountourios P, Drummer HE.
18 Distinct roles in folding, CD81 receptor binding and viral entry for conserved
19 histidines of HCV glycoprotein E1 and E2. Biochem J 2012.
- 20 34. Roccasecca R, Ansuini H, Vitelli A, Meola A, Scarselli E, Acali S, Pezzanera
21 M, Ercole BB, McKeating J, Yagnik A, Lahm A, Tramontano A, Cortese R,
22 Nicosia A. Binding of the hepatitis C virus E2 glycoprotein to CD81 is strain
23 specific and is modulated by a complex interplay between hypervariable
24 regions 1 and 2. J Virol 2003;77:1856-67.

- 1 35. McCaffrey K, Boo I, Pountourios P, Drummer HE. Expression and
2 characterization of a minimal hepatitis C virus glycoprotein E2 core domain
3 that retains CD81 binding. *J Virol* 2007;81:9584-90.
- 4 36. Harris HJ, Davis C, Mullins JG, Hu K, Goodall M, Farquhar MJ, Mee CJ,
5 McCaffrey K, Young S, Drummer H, Balfe P, McKeating JA. Claudin
6 association with CD81 defines hepatitis C virus entry. *J Biol Chem*
7 2010;285:21092-102.
- 8 37. Law M, Maruyama T, Lewis J, Giang E, Tarr AW, Stamatakis Z, Gastaminza P,
9 Chisari FV, Jones IM, Fox RI, Ball JK, McKeating JA, Kneteman NM, Burton
10 DR. Broadly neutralizing antibodies protect against hepatitis C virus
11 quasispecies challenge. *Nat Med* 2008;14:25-7.
- 12 38. Vanwolleghem T, Bukh J, Meuleman P, Desombere I, Meunier JC, Alter H,
13 Purcell RH, Leroux-Roels G. Polyclonal immunoglobulins from a chronic
14 hepatitis C virus patient protect human liver-chimeric mice from infection with a
15 homologous hepatitis C virus strain. *Hepatology* 2008;47:1846-55.
- 16 39. Rychlowska M, Owsianka AM, Fong SK, Dubuisson J, Bienkowska-
17 Szewczyk K, Patel AH. Comprehensive linker-scanning mutagenesis of the
18 hepatitis C virus E1 and E2 envelope glycoproteins reveals new structure-
19 function relationships. *J Gen Virol* 2011;92:2249-61.
- 20
21
22
23
24
25
26

FIGURE LEGENDS

1
2 **Figure 1. Positions 447, 458 and 478 confer enhanced viral entry of a high-**
3 **infectivity variant re-infecting the liver graft.** (A) Genomic organisation and
4 mutations of envelope glycoproteins of escape variant VL and nonselected variants
5 VC and VA. HVR1 and HVR2 are depicted in green; E2 domains in red (DI), yellow
6 (DII) and blue (DIII); and CD81 binding domains in dark blue. ^{29, 33, 39} Positions 447,
7 458 and 478 are highlighted in black vertical lines. Differences between VL, VC and
8 VA in region E1E2₃₈₄₋₄₈₃ are displayed. (B-C) Viral entry in Huh7.5.1 cells of the
9 escape variant VL, the nonselected variants VC and VA as well as chimeric variants
10 containing defined mutations of VC and VA in VL or vice-versa (see Fig. S1). HCVpp
11 infection was analyzed by luciferase reporter gene expression. Results are
12 expressed as percentage of viral entry compared to VL. Means \pm SD from at least four
13 independent experiments performed in triplicate are shown. Significant differences in
14 HCVpp entry between variants are indicated (*, $P \leq .05$; **, $P < .001$). Abbreviations:
15 aa - amino acid; BD - binding domain; n.s. - not significant

16
17 **Figure 2. Altered usage of CD81 is responsible for enhanced viral entry of the**
18 **escape variant.** (A) Entry factor expression in clones of SR-BI-, CD81-, CLDN1- or
19 OCLN-transduced Huh7.5.1 cells. The relative overexpression of each entry factors
20 was determined by flow cytometry and is indicated as fold expression compared to
21 parental Huh7.5.1 cells. (B) Entry factor expression in pools of CD81-overexpressing
22 Huh7.5.1 cells (grey bars). The relative entry factor expression was determined as
23 described in (A). (C) Receptor-dependency of patient-derived HCVpp entry. Parental
24 and transduced Huh7.5.1 cells were incubated with parental or chimeric HCVpp and
25 viral entry was determined as described in Fig. 1. Viral entry is expressed as fold
26 change of viral entry compared to parental cells. Means \pm SD from three independent

1 experiments performed in triplicate are shown. Significant differences in HCVpp entry
2 between variants are indicated (**, $P < .001$).

3

4 **Figure 3. Different CD81 usage of viral variants in Huh7.5 cells with silenced**
5 **CD81 expression.** (A) Entry factor expression in Huh7.5 cells with silenced CD81
6 (grey bars) or CD13 (black bars) expression. CD81 expression was determined by
7 flow cytometry and is indicated as fold expression compared to control shCD13-
8 Huh7.5 cells. (B-C) Entry of patient-derived HCVpp VL, VC (B) and VA (C). Huh7.5
9 cells with silenced CD81 or CD13 expression were incubated with parental or
10 chimeric HCVpp and viral entry was determined as described in Fig. 1. Viral entry is
11 expressed as fold change of viral entry compared to shCD13-Huh7.5 control cells.
12 Means \pm SD from three independent experiments performed in triplicate are shown.
13 Significant differences in HCVpp entry between wildtype and chimeric variants are
14 indicated (**, $P < .001$). (D) Entry kinetics of patient-derived variants. Kinetics of
15 HCVpp entry was performed using anti-CD81 or isotype control antibody (5 μ g/ml).
16 HCV entry was determined as described in Fig.1. A representative experiment out of
17 four is shown.

18

19 **Figure 4. Positions 447, 458 and 478 mediate viral escape from neutralization**
20 **by autologous transplant serum.** Neutralization of the escape variant VL, variants
21 VC and VA and the chimeric strains. HCVpp were incubated with autologous anti-
22 HCV positive or control serum in serial dilutions for 1 h at 37°C before incubation with
23 Huh7.5.1 cells. Neutralization titers obtained by endpoint dilution are indicated.
24 Dotted line indicates the threshold for a positive neutralization titer (1/40). Means \pm SD
25 from at least four experiments performed in triplicate are shown. (A) Neutralization of
26 variants VL, VL containing individual or combined mutations of VC and VC with

1 double substitutions of VL by autologous anti-HCV positive pre-transplant serum. (B)
2 Neutralization of variants VL, VL containing individual mutations of VA and VA with
3 single substitution of VL by autologous anti-HCV positive pre-transplant serum.
4 Significant differences in neutralization between variants are indicated (*, $P \leq .05$; **, $P < .001$).
5

6

7 **Figure 5. Mechanisms of viral evasion from neutralizing antibodies.** (A-B)

8 Escape from neutralization by HMABs directed against conformational and linear
9 epitopes. HCVpp produced from isolates shown in Fig. 1 were incubated with HMABs
10 (Table S1) or control Ab (10 $\mu\text{g/ml}$) for 1 h at 37°C prior to incubation with Huh7.5.1
11 cells. Results are expressed as percentage of viral entry relative to HCVpp incubated
12 with control mAb. Means \pm SD from at least four experiments performed in triplicate
13 are shown. Significant differences in HCVpp entry between variants are indicated (**, $P < .001$). (C-D) Escape from neutralization of anti-E2 antibody CBH-23 in kinetic
14 assays. Kinetics were performed as described in Fig. 3 (HMAb 10 $\mu\text{g/ml}$; JS-81: 5
15 $\mu\text{g/ml}$). A representative experiment out of four is shown.
16

17

18 **Figure 6. HCV VL strain is poorly neutralized by antibodies present in sera from**

19 **a large panel of non-related patients with chronic HCV infection.** Parental
20 HCVpp (VL, VC and VA) and chimeric HCVpp (VLVC₄₅₈₊₄₇₈ and VLVA₄₄₇) strains,
21 adjusted for p24 antigen expression, were preincubated for 1 h with serial dilutions of
22 anti-HCV positive sera from randomly selected patients with chronic hepatitis C prior
23 to incubation with Huh7.5.1 target cells. Patient number, gender, HCV genotype and
24 viral load are indicated in Table S2. Neutralization was determined as in Fig. 4. Mean
25 neutralization titers are marked by lines. Means from at least three independent

1 experiments performed in triplicate are shown. Significant differences in
2 neutralization are indicated.

3

4 **Figure 7. Entry viral and escape from neutralization of chimeric HCVcc**
5 **expressing patient-derived viral envelopes.** (A) Infectivity of HCVcc expressing
6 envelopes of variant VL and functional residues of VA and VC is indicated by TCID₅₀.
7 Means±SD from one representative experiment are shown. (B) Relative infectivity of
8 chimeric HCVcc expressing patient-derived viral envelopes in Huh7.5 cells with
9 silenced CD81 or CD13 expression. Means±SD from three independent experiments
10 performed in triplicate are shown. (C) Escape from neutralization by HMAb CBH-23.
11 Neutralization was performed as described in Fig. 5. Results are expressed as
12 percentage of viral infectivity relative to HCVcc incubated with control mAb.
13 Means±SD from at least three experiments performed in triplicate are shown. (D)
14 Inhibition of HCVcc infection by anti-HCV positive sera described in Table S2B.
15 Neutralization was performed as described in Fig. 6. Means from one representative
16 experiment performed in triplicate are shown. Significant differences in HCVcc
17 infection between wildtype and chimeric variants are indicated (*, $P \leq .05$; **, $P <$
18 $.001$)

19

20

Figure 1

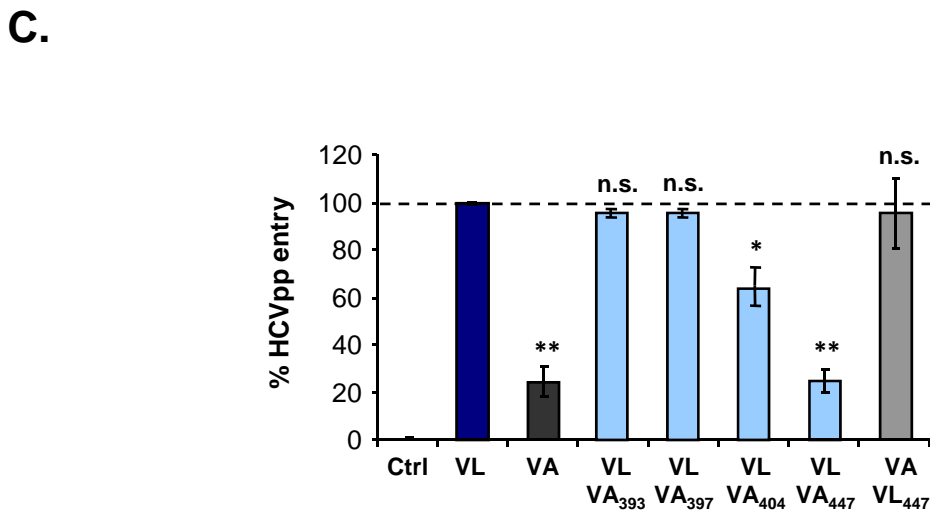
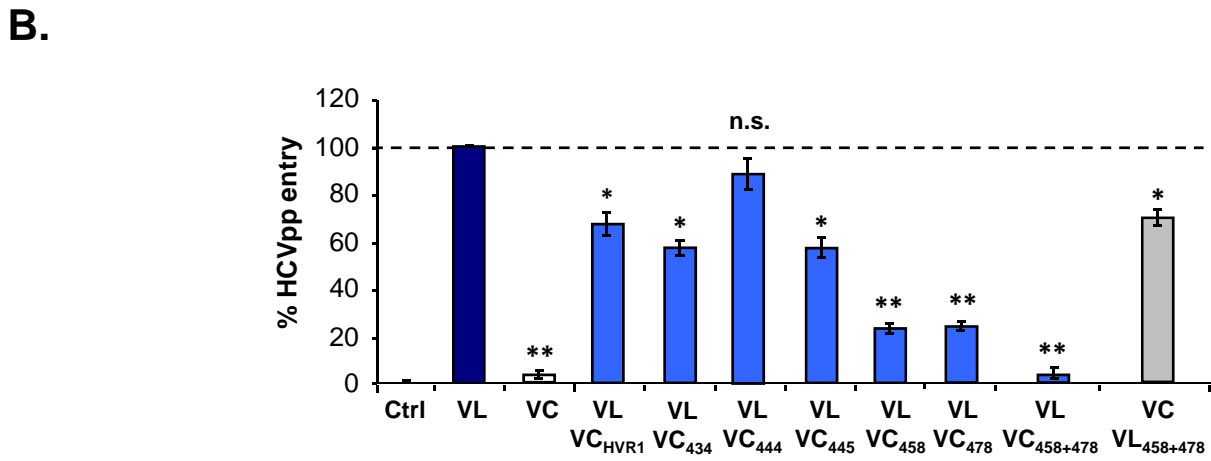
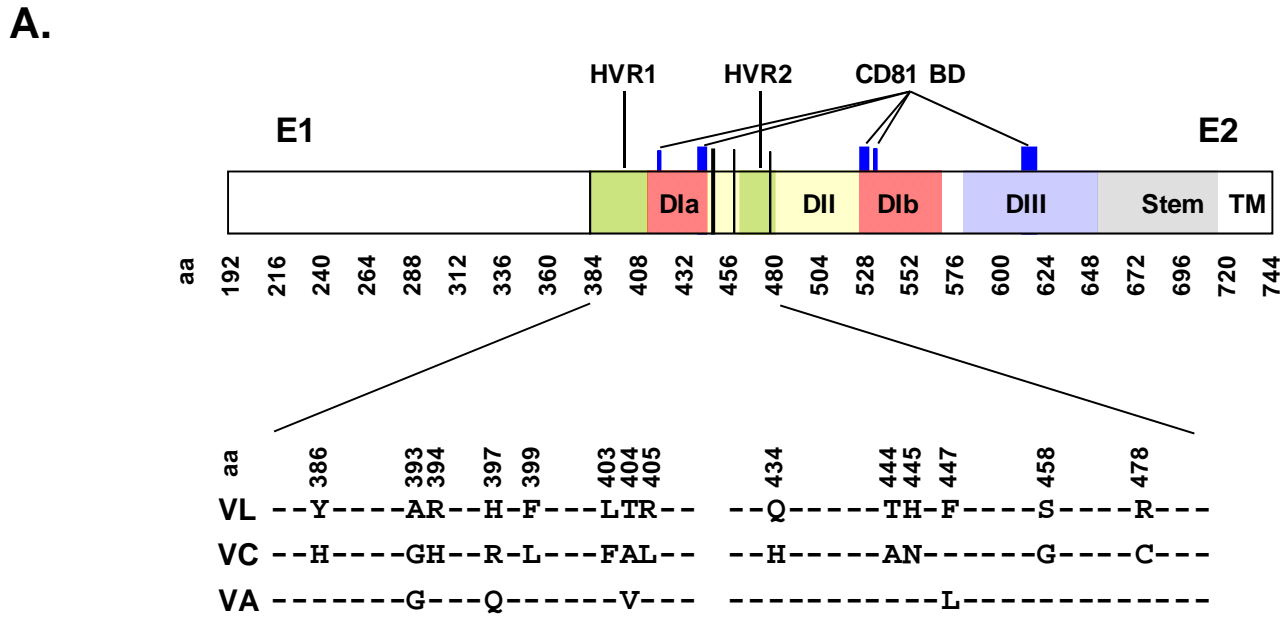

Figure 1

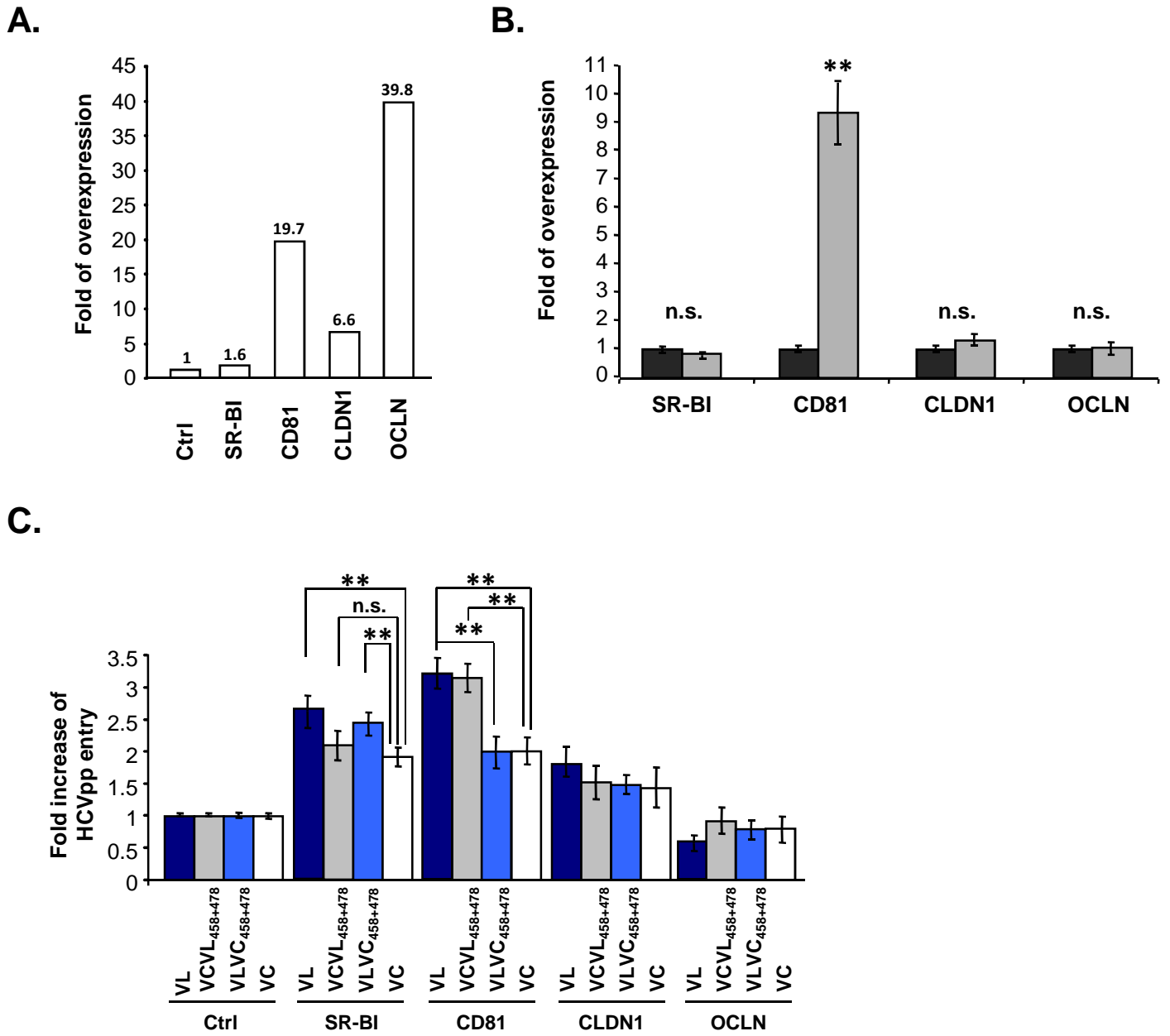
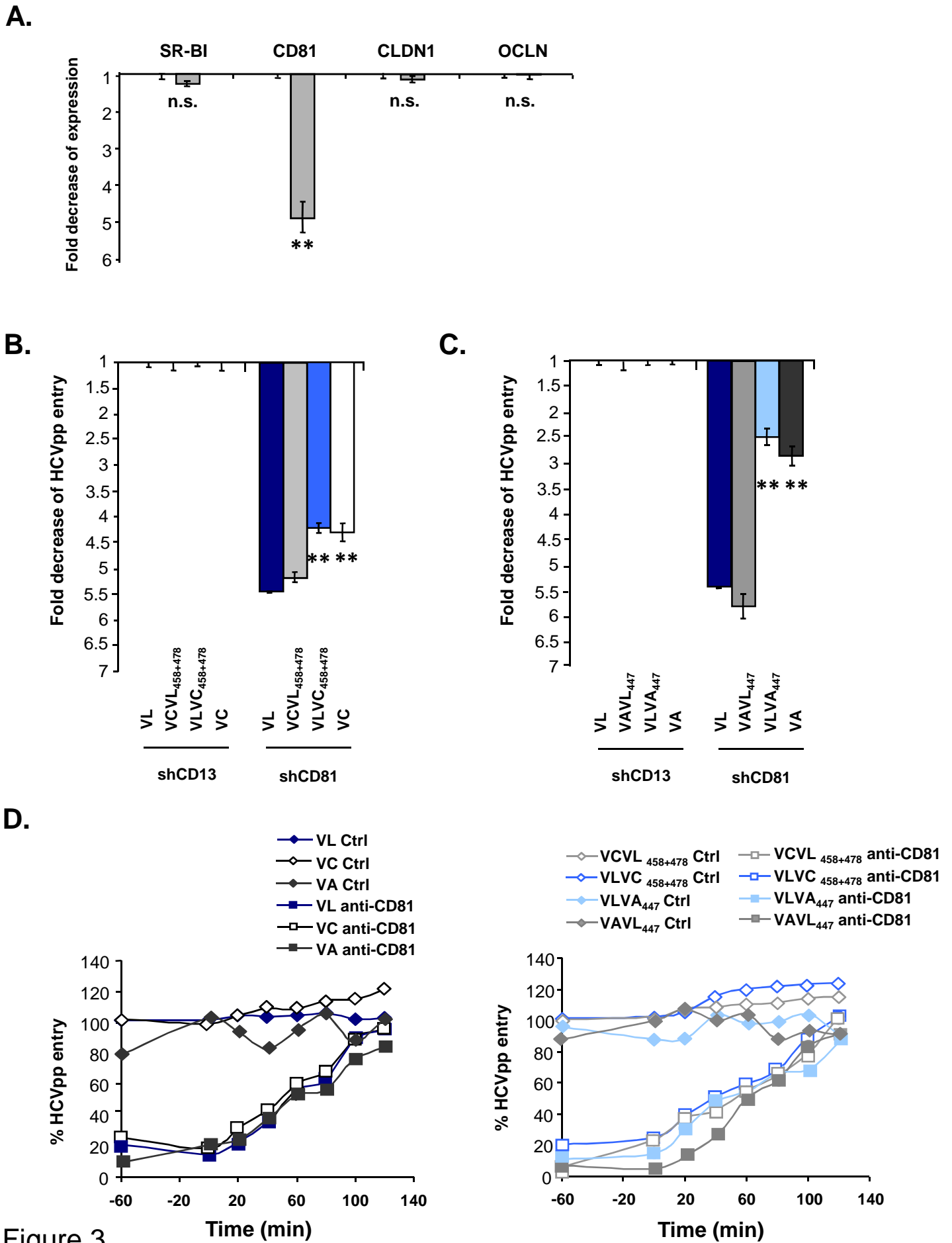
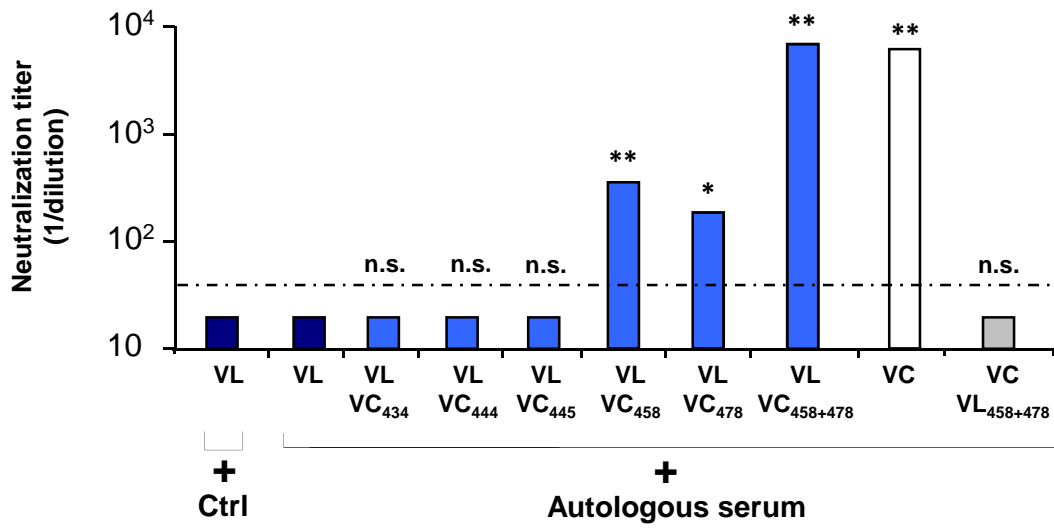

Figure 2



A.



B.

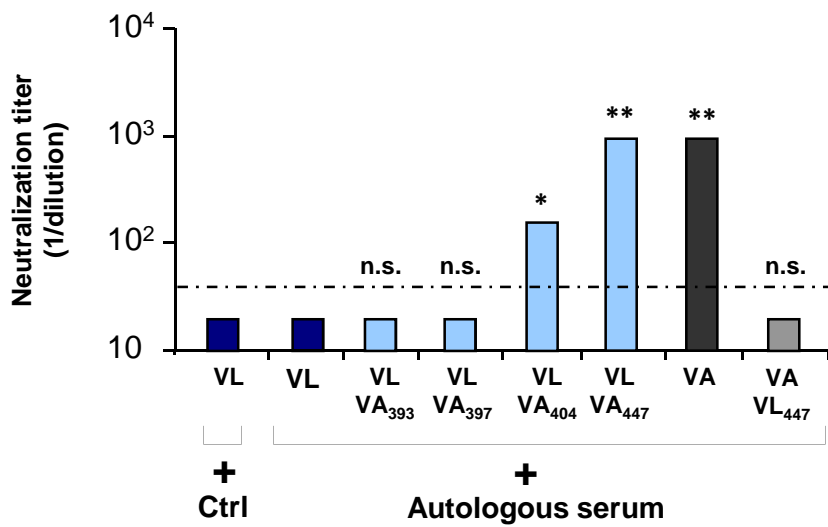

Figure 4

Figure 5

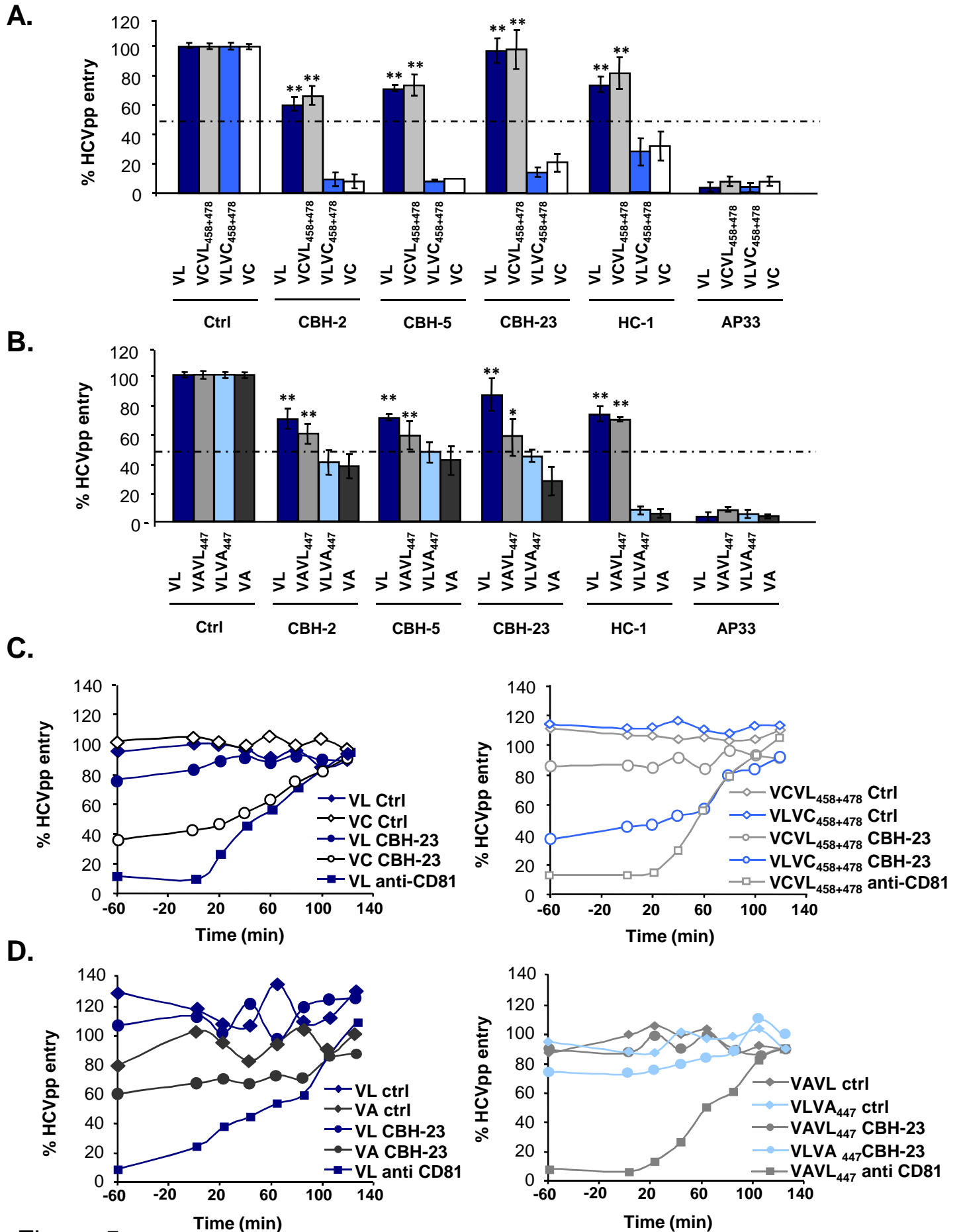

Figure 5

Figure 6

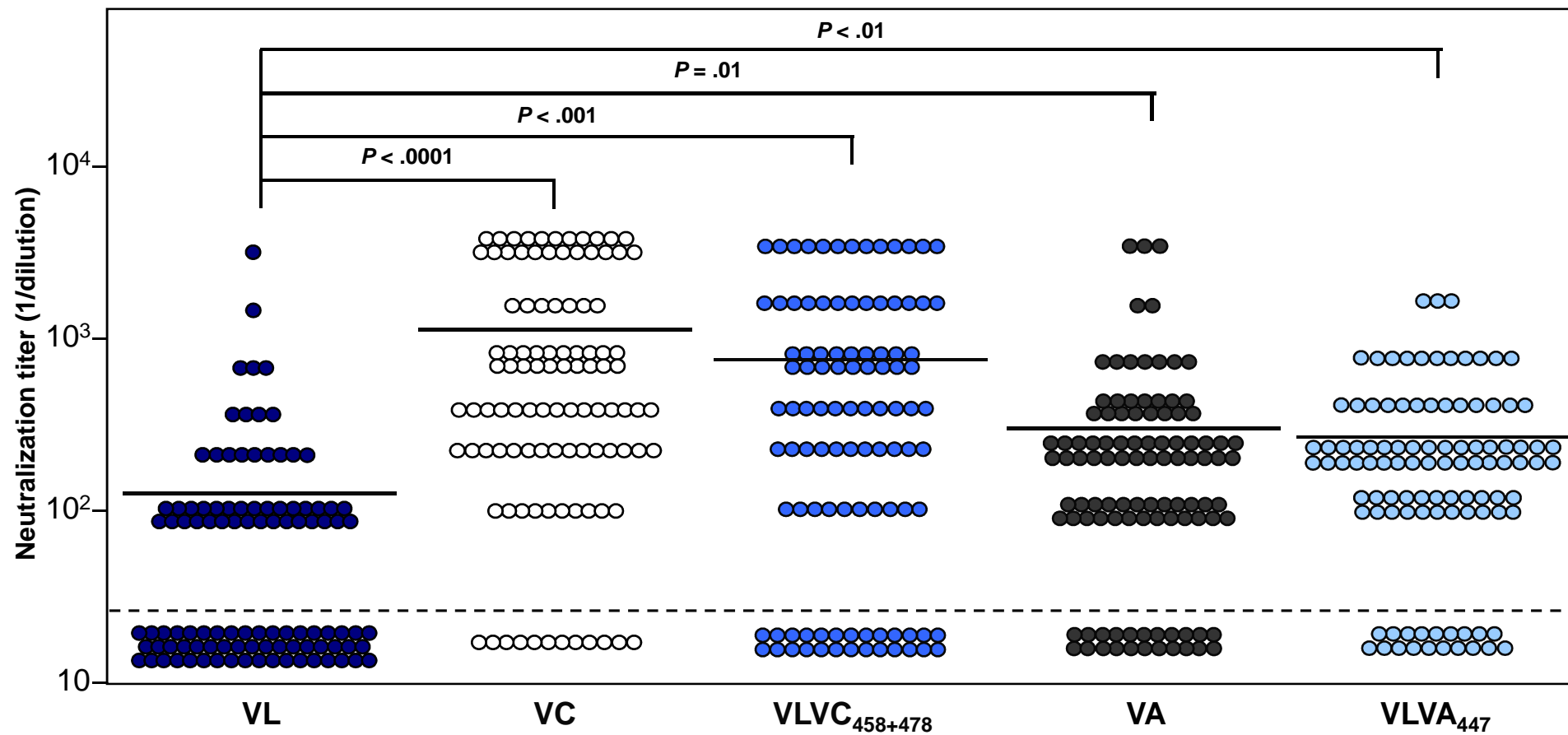

Figure 6

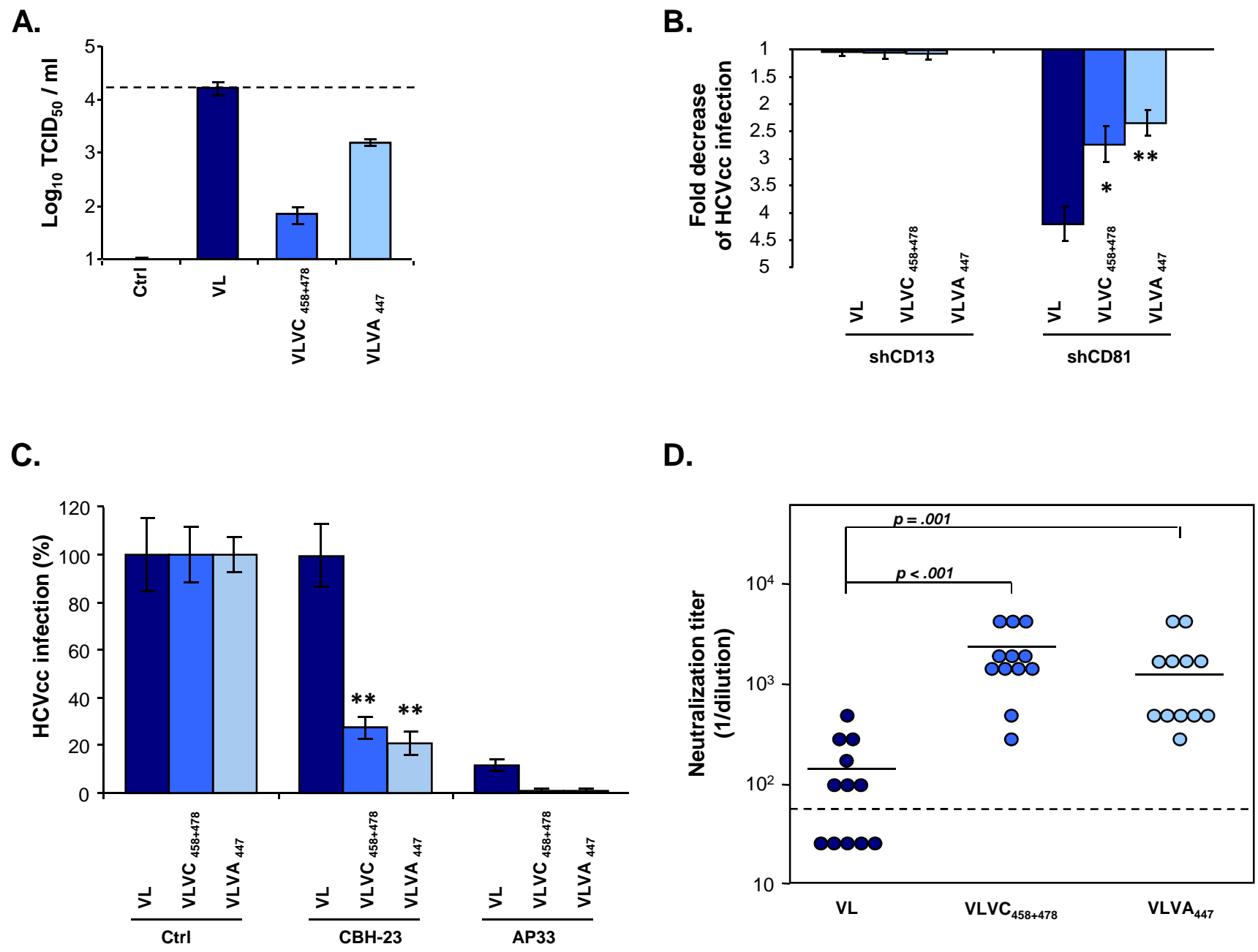

Figure 7

MS# GASTRO-D-11-01111.R1

1 **SUPPLEMENTARY DATA**

2

3 **SUPPLEMENTARY MATERIALS AND METHODS**

4 **Analysis of HCVpp envelope glycoprotein expression.** Expression of HCV
5 glycoproteins was characterized in HEK 293T producer cells and HCVpp purified
6 through a 20% sucrose cushion ultracentrifugation as described.¹ Immunoblots of
7 HCV glycoproteins were performed using anti-E1 11B7 and anti-E2 AP33 mAbs as
8 described.²

9

10 **Cellular binding of envelope glycoproteins.** Envelope glycoprotein-expressing
11 HEK 293T cells were lysed in PBS by four freezing and thawing cycles. Cell debris
12 and nuclei were removed by low-speed centrifugation and supernatants containing
13 native intracellular E1E2 complexes were used for binding studies. shCD81- or
14 shCD13-Huh7.5 cells (2×10^5 cells per well) were seeded in 96 well plates. Following
15 incubation with lysates containing patient-derived E1E2 proteins, Huh7.5.1 target
16 cells were first incubated with mAb AP33 (10 $\mu\text{g/ml}$) and then with phycoerythrin-
17 conjugated anti-mouse Ab (5 $\mu\text{g/ml}$, BD). Bound E2 was analyzed by flow cytometry
18 as described.³

19

20 **Construction of plasmids for production of chimeric HCVcc expressing patient-**
21 **derived envelopes.** Genotype 1 JFH-based HCVcc chimeras expressing the
22 structural proteins of patient-derived viruses were produced as previously described
23 for Con1/C3-JFH1-V2440L.^{4,5} Briefly, the cDNA region encoding for the HCV core to
24 first transmembrane domain of NS2 (C3 junction site) from variant VL was inserted
25 into pFK-Con1/C3-JFH1-V2440L using fusion polymerase chain reaction (PCR) with
26 Pfu DNA polymerase (Stratagene) and standard cloning procedures using

1 appropriate restriction sites including BsmI and AvrII. The obtained construct was
2 designated VL/JFH1. VL/JFH1 encoding sequence was used as template to insert
3 individual and combined mutations using the QuikChange II XL site-directed as
4 described previously.¹

5
6 **GNA Capture ELISA.** Binding of HMAb CBH-23 to viral envelopes was analyzed
7 using an ELISA with HCVpp as a capture antigen as described.⁶ HCVpp expressing
8 the E1E2 glycoproteins of HCV variants or control (Ctrl) pseudoparticles with absent
9 HCV envelope glycoprotein expression were partially purified and enriched through
10 ultracentrifugation as described.¹ Purified particles were quantified as described
11 before.¹ Partially purified HCVpp or control pseudoparticles were captured onto GNA-
12 coated microtiter plates as described.⁶ Soluble E2 (sE2, derived from strain HCV-H77
13 and expressed in 293T cells as described previously³) was used as a positive control
14 for antibody binding. Neutralizing human anti-E2 antibody CBH-23 (25 µg/ml diluted
15 in PBS) was then added to captured HCVpp or sE2 (1 h at RT). Following washing
16 and removal of nonbound antibody, mAb binding to HCV envelopes was detected
17 using horseradish peroxidase anti-human IgG (GEhealthcare) at a concentration of
18 1/3000 for 1 h at RT, followed by incubation with 1-stepTM Turbo TMB-ELISA
19 (Thermo Scientific) for color development. Absorbance was measured at 450 nm
20 using a microplate reader (Molecular Devices) and the Softmax program.

21
22 **Bioinformatics.** Multiple sequence alignment of complete E2 proteins was
23 performed using the European HCV databases (<http://euhcvdb.ibcp.fr>).⁷ Two amino-
24 acid repertoires were computed with all E2 sequences of provisional/confirmed
25 genotype 1b using the *ComputeRepertoire* tool as part of the euHCVdb *Extract* tool.

26

1 **SUPPLEMENTARY RESULTS**

2 **Prevalence of the identified mutations in a large genomic database of viral**

3 **isolates.** Bioinformatic sequence analysis of a large panel of 2,074 HCV strains

4 within the European HCV database further supports the potential relevance of the

5 identified positions for pathogenesis of HCV infection in general.⁷ Residues F, S and

6 R are much more frequently observed at positions 447, 458 and 478 than L, G and

7 C. F and S are the most predominant residues at positions 447 and 458 in the large

8 majority of 1b strains, respectively (F447 all: 98.4%, 1b: 96.2%; S458 all: 94% for 1b:

9 90.3%; Fig. S5). The position 478 is variable but R (all: 2.4% for 1b: 10.8%) is more

10 frequent than C (all: 0.2%, 1b: 0.9%) (Fig. S5). The high prevalence of identified

11 residues supports their functional relevance for virus survival and selection as more

12 structurally and functionally relevant residues will be more frequently observed.

13 These data suggest that the epitope containing the identified residues at positions

14 447, 458 and 478 is not only responsible for viral evasion from autologous antiviral

15 antibodies during LT but may also contribute to viral evasion in chronic HCV infection

16 in general.

17

18

19

20

1 **SUPPLEMENTARY TABLE LEGENDS AND TABLES**

2 **Table S1. Neutralization of patient-derived and chimeric HCVpp by monoclonal**
3 **anti-envelope antibodies.** HCVpp produced from isolates shown in Figure 1 were
4 incubated with mAbs (10 µg/ml) for 1 h at 37°C. HCVpp-antibody complexes were
5 then added to Huh7.5.1 cells. Viral epitopes targeted by the respective antibody,
6 percentage of HCV entry in the presence of antibody (strains VL, VC, VCVL₄₅₈₊₄₇₈,
7 VLVC₄₅₈₊₄₇₈, VA, VAVL₄₄₇ and VLVA₄₄₇) and source or reference of antibody are
8 shown. Means±SD from at least three experiments each performed in triplicate are
9 shown. Abbreviations: V - viral variant; aa - amino acid.

10

11

Antibody	Source or reference	Epitope (aa)	HCVpp entry (%)						
			VL	VC	VCVL ₄₅₈₊₄₇₈	VLVC ₄₅₈₊₄₇₈	VA	VAVL ₄₄₇	VLVA ₄₄₇
AP33	8	412-423	6 ± 3	12 ± 1	3 ± 1	11 ± 5	2 ± 1	5 ± 1	3 ± 1
IGH461	9	436-448	58 ± 4	56 ± 8	51 ± 7	53 ± 3	55 ± 2	56 ± 6	52 ± 7
16A6	9	523-530	76 ± 10	74 ± 8	83 ± 9	82 ± 2	73 ± 9	74 ± 4	81 ± 9
CBH-2	10	Domain B, conformational 431, 523-540	60 ± 5	8 ± 5	65 ± 6	9 ± 5	39 ± 8	61 ± 4	39 ± 10
CBH-5	10	Domain B, conformational 523-540	71 ± 2	10 ± 4	73 ± 7	8 ± 1	36 ± 5	59 ± 7	47 ± 8
CBH-23	Keck and Foug, unpublished	Domain C, conformational	97 ± 9	21 ± 6	98 ± 13	14 ± 3	32 ± 7	53 ± 12	44 ± 3
HC-1	11	Domain B, conformational 523-540	73 ± 5	31 ± 9	81 ± 10	27 ± 9	2 ± 1	2 ± 1	77 ± 1

12

1 **Table S2. Characteristics of patients and viruses used for neutralization**
2 **studies.** (A) HCVpp were incubated with anti-HCV positive sera from 102 patients
3 with chronic HCV infection (ClinicalTrial.gov Identifier NCT00638144). Patient
4 number, age, gender, viral genotype and load in serum are indicated. HCVpp-
5 antibody complexes were added to Huh7.5.1 cells and infection was analyzed as
6 described in Fig. 4. Calculation of neutralization and determination of background
7 and thresholds for neutralization were performed as described in Fig. 6.
8 Neutralization titers obtained by endpoint dilution are indicated for each variant. (B)
9 Results were confirmed using chimeric HCVcc expressing the HCV envelope
10 glycoproteins depicted in Fig. 7 and using 12 representative sera from patients.
11 Neutralization assays were performed using a similar protocol as described in (A).
12 Means from at least three independent experiments each performed in triplicate are
13 shown. Abbreviations: V - viral variant ; M - male ; F - female.

14 **A.**

Patient number	Age	Gender	Genotype	Viral Load (IU/mL)	HCVpp neutralization titer (1/dilution)		
					VL	VC	VA
1	65	M	1b	2.29×10^9	100	100	100
2	27	F	1b	9.7×10^4	100	3200	200
3	31	F	1b	1.53×10^5	400	3200	400
4	47	M	3a	1.02×10^6	20	20	100
5	58	M	1b	1.15×10^6	100	3200	200
6	72	M	1b	1.50×10^6	20	200	100
7	51	M	4	4.38×10^6	20	20	20
8	69	F	1b	9.7×10^5	20	400	100
9	36	F	1	1.29×10^5	800	1600	100
10	46	M	1a	1.05×10^6	100	800	100
11	55	M	1a	1.54×10^6	400	3200	200
12	56	M	4c/4d	2.41×10^4	20	800	200
13	56	F	4a	1.09×10^6	100	400	400
14	59	F	1b	3.54×10^5	200	800	200
15	62	M	1a	3.37×10^6	20	20	20
16	50	M	4a	1.48×10^6	20	200	20

MS# GASTRO-D-11-01111.R1

17	46	M	4a	4×10^5	20	200	100
18	70	F	1b	1.3×10^6	100	800	20
19	77	F	1b	6.2×10^4	20	100	100
20	61	F	1b	2.58×10^4	200	800	200
21	46	F	1b	2.11×10^5	100	400	800
22	36	M	1a	2.04×10^6	20	200	400
23	52	F	4a	9.12×10^5	20	3200	400
24	54	M	1a	9.77×10^5	100	800	200
25	54	M	1b	1.12×10^6	20	100	200
26	54	F	1a	3.38×10^6	20	400	20
27	47	M	3a	6.16×10^5	100	3200	3200
28	43	M	1a	5.75×10^6	20	800	200
29	51	M	4a	1.44×10^6	100	400	400
30	54	M	2c	4.67×10^5	100	100	3200
31	51	M	1a	6.16×10^6	100	400	100
32	39	M	4a	1.12×10^6	20	200	800
33	62	F	4f	2.88×10^6	20	800	20
34	46	M	4k	3.54×10^5	20	20	100
35	42	M	1a	9.54×10^5	400	800	400
36	54	M	2c	4.67×10^5	200	3200	100
37	34	M	3a	3.23×10^6	20	20	100
38	47	M	3a	7.94×10^4	20	400	20
39	30	F	1b	1.00×10^6	20	200	400
40	47	F	1b	2.29×10^6	100	400	200
41	52	M	1a	1.73×10^6	200	3200	400
42	34	M	1b	1.45×10^6	3200	3200	200
43	46	M	1a	4.34×10^6	200	800	400
44	66	F	1b	3.89×10^5	200	1600	200
45	29	F	1a	1.08×10^5	400	400	200
46	45	M	3a	2.78×10^5	20	200	200
47	65	F	4f	1.46×10^6	20	3200	20
48	55	M	1a	8.81×10^6	20	800	100
49	53	M	1a	1.15×10^6	100	100	100
50	40	M	3a	2.46×10^6	100	3200	200
51	48	F	1a	1.00×10^5	20	800	20
52	37	M	1a	5.08×10^6	20	400	200
53	47	M	3a	6.8×10^6	100	1600	400
54	37	M	1a	1.84×10^6	800	800	200
55	65	F	1b	2.18×10^6	100	100	800
56	45	F	1a	3.93×10^6	1600	1600	400
57	49	M	4a	2.06×10^6	800	3200	200

MS# GASTRO-D-11-01111.R1

58	30	M	1b	7.21×10^5	100	800	200
59	31	M	3a	6.66×10^6	100	200	200
60	37	M	1a	6.70×10^6	20	100	100
61	49	M	1a	3.16×10^5	20	800	20
62	43	M	1	6.83×10^5	20	20	20
63	69	M	1b	4.7×10^5	20	20	200
64	48	M	1a	3.28×10^6	20	3200	100
65	46	M	3a	8.55×10^5	20	800	100
66	51	M	1b	1.07×10^6	20	200	1600
67	43	M	1b	4.27×10^5	20	100	800
68	36	M	3a	1.14×10^6	20	800	20
69	53	F	1b	3.06×10^5	20	400	20
70	24	F	3a	1.29×10^6	20	20	20
71	63	M	1b	3.01×10^6	100	200	100
72	44	M	1	1.10×10^5	20	3200	200
73	28	M	3a	1.85×10^6	20	3200	20
74	54	M	1b	1.29×10^5	20	3200	20
75	17	F	1b	2.41×10^5	20	20	200
76	40	M	3a	1.26×10^6	20	20	100
77	35	M	1b	8.89×10^5	20	20	800
78	36	F	6a	1.4×10^7	20	100	400
79	70	F	1b	1.13×10^5	100	100	400
80	62	M	1a	2.68×10^6	100	200	20
81	70	M	1b	2.85×10^5	20	200	3200
82	63	M	1b	1.95×10^5	200	400	400
83	33	M	1a	1.76×10^6	100	200	800
84	35	M	1a	2.78×10^6	20	20	200
85	60	F	1	6.39×10^5	20	200	100
86	57	M	3a	1.22×10^6	200	3200	400
87	60	M	1	3.6×10^6	100	3200	20
88	49	M	4	2.24×10^6	20	1600	20
89	37	M	4	9.35×10^5	100	800	100
90	55	M	1a	3.77×10^6	20	3200	100
91	47	M	1a	2.36×10^6	20	1600	20
92	72	M	3a	3.83×10^5	20	400	20
93	79	M	1b	2.81×10^5	100	1600	100
94	58	F	1b	6.58×10^5	100	3200	200
95	50	M	3a	6.07×10^5	20	3200	100
96	67	F	1b	4.13×10^5	100	800	20
97	49	M	3a	5.22×10^5	200	400	200
98	53	F	1b	2.31×10^6	20	400	1600

MS# GASTRO-D-11-01111.R1

99	37	M	1a	1.87×10^5	100	3200	200
100	54	F	4a	9.23×10^5	20	200	100
101	39	M	1a	1.76×10^5	100	800	200
102	51	F	2b	1.10×10^6	100	3200	800

1

2 **B.**

Patient number	HCVcc neutralization titer (1/dilution)		
	VL	VLVC ₄₅₈₊₄₇₈	VLVA ₄₄₇
11	400	1600	800
28	20	1600	800
33	20	400	400
35	400	1600	1600
36	200	1600	3200
45	800	1600	800
65	20	1600	1600
66	20	3200	800
68	20	1600	1600
94	100	3200	800
98	100	800	3200
99	100	3200	1600

3

4

5

1 **REFERENCES**

- 2 1. Fafi-Kremer S, Fofana I, Soulier E, Carolla P, Meuleman P, Leroux-Roels G,
3 Patel AH, Cosset F-L, Pessaux P, Doffoël M, Wolf P, Stoll-Keller F, Baumert
4 TF. Enhanced viral entry and escape from antibody-mediated neutralization
5 are key determinants for hepatitis C virus re-infection in liver transplantation. *J*
6 *Exp Med* 2010;207:2019-2031.
- 7 2. Pestka JM, Zeisel MB, Blaser E, Schurmann P, Bartosch B, Cosset FL, Patel
8 AH, Meisel H, Baumert J, Viazov S, Rispeter K, Blum HE, Roggendorf M,
9 Baumert TF. Rapid induction of virus-neutralizing antibodies and viral
10 clearance in a single-source outbreak of hepatitis C. *Proc Natl Acad Sci U S A*
11 2007;104:6025-30.
- 12 3. Krieger SE, Zeisel MB, Davis C, Thumann C, Harris HJ, Schnober EK, Mee C,
13 Soulier E, Royer C, Lambotin M, Grunert F, Dao Thi VL, Dreux M, Cosset FL,
14 McKeating JA, Schuster C, Baumert TF. Inhibition of hepatitis C virus infection
15 by anti-claudin-1 antibodies is mediated by neutralization of E2-CD81-claudin-
16 1 associations. *Hepatology* 2010;51:1144-57.
- 17 4. Pietschmann T, Kaul A, Koutsoudakis G, Shavinskaya A, Kallis S, Steinmann
18 E, Abid K, Negro F, Dreux M, Cosset FL, Bartenschlager R. Construction and
19 characterization of infectious intragenotypic and intergenotypic hepatitis C
20 virus chimeras. *Proc Natl Acad Sci U S A* 2006;103:7408-13.
- 21 5. Kaul A, Woerz I, Meuleman P, Leroux-Roels G, Bartenschlager R. Cell culture
22 adaptation of hepatitis C virus and in vivo viability of an adapted variant. *J Virol*
23 2007;81:13168-79.
- 24 6. Wang Y, Keck ZY, Saha A, Xia J, Conrad F, Lou J, Eckart M, Marks JD,
25 Fong SK. Affinity maturation to improve human monoclonal antibody

- 1 neutralization potency and breadth against hepatitis C virus. *J Biol Chem*
2 2011;286:44218-33.
- 3 7. Combet C, Garnier N, Charavay C, Grando D, Crisan D, Lopez J, Dehne-
4 Garcia A, Geourjon C, Bettler E, Hulo C, Le Mercier P, Bartenschlager R,
5 Diepolder H, Moradpour D, Pawlotsky JM, Rice CM, Trepo C, Penin F,
6 Deleage G. euHCVdb: the European hepatitis C virus database. *Nucleic Acids*
7 *Res* 2007;35:D363-6.
- 8 8. Owsianka A, Tarr AW, Juttla VS, Lavillette D, Bartosch B, Cosset FL, Ball JK,
9 Patel AH. Monoclonal antibody AP33 defines a broadly neutralizing epitope on
10 the hepatitis C virus E2 envelope glycoprotein. *J Virol* 2005;79:11095-104.
- 11 9. Haberstroh A, Schnober EK, Zeisel MB, Carolla P, Barth H, Blum HE, Cosset
12 FL, Koutsoudakis G, Bartenschlager R, Union A, Depla E, Owsianka A, Patel
13 AH, Schuster C, Stoll-Keller F, Doffel M, Dreux M, Baumert TF. Neutralizing
14 host responses in hepatitis C virus infection target viral entry at postbinding
15 steps and membrane fusion. *Gastroenterology* 2008;135:1719-1728.
- 16 10. Hadlock KG, Lanford RE, Perkins S, Rowe J, Yang Q, Levy S, Pileri P,
17 Abrignani S, Fong SK. Human monoclonal antibodies that inhibit binding of
18 hepatitis C virus E2 protein to CD81 and recognize conserved conformational
19 epitopes. *J Virol* 2000;74:10407-16.
- 20 11. Keck ZY, Li SH, Xia J, von Hahn T, Balfe P, McKeating JA, Witteveldt J, Patel
21 AH, Alter H, Rice CM, Fong SK. Mutations in hepatitis C virus E2 located
22 outside the CD81 binding sites lead to escape from broadly neutralizing
23 antibodies but compromise virus infectivity. *J Virol* 2009;83:6149-60.
- 24 12. Dimitrova M, Affolter C, Meyer F, Nguyen I, Richard DG, Schuster C,
25 Bartenschlager R, Voegel JC, Ogier J, Baumert TF. Sustained delivery of

- 1 siRNAs targeting viral infection by cell-degradable multilayered polyelectrolyte
2 films. Proc Natl Acad Sci U S A 2008;105:16320-5.
- 3 13. Lupberger J, Zeisel MB, Xiao F, Thumann C, Fofana I, Zona L, Davis C, Mee
4 CJ, Turek M, Gorke S, Royer C, B. F, Zahid MN, Lavillette D, J. F, Cosset F-L,
5 Rothenberg SM, Pietschmann T, Patel AH, Pessaux P, Doffoël M,
6 Raffelsberger W, Poch O, McKeating JA, Brino L, Baumert TF. EGFR and
7 EphA2 are hepatitis C virus host entry factors and targets for antiviral therapy.
8 Nat Med 2011;17:589-95.
- 9 14. Bartosch B, Vitelli A, Granier C, Goujon C, Dubuisson J, Pascale S, Scarselli
10 E, Cortese R, Nicosia A, Cosset FL. Cell entry of hepatitis C virus requires a
11 set of co-receptors that include the CD81 tetraspanin and the SR-B1
12 scavenger receptor. J Biol Chem 2003;278:41624-41630.
- 13
14

1 **SUPPLEMENTARY FIGURE LEGENDS**

2 **Figure S1. Actual viral infectivity of HCVpp derived from variants VL, VC and**
3 **VA shown as relative light units of luciferase reporter gene expression. (A-B)**

4 Comparative analysis of viral entry of HCVpp shown in Fig. 1. Results are expressed
5 in relative light units (RLU) plotted in a logarithmic scale. The threshold for a
6 detectable infection in this system is indicated by dashed lines. The detection limit for
7 positive luciferase reporter protein expression was 3×10^3 RLU/assay, corresponding
8 to the mean \pm 3 SD of background levels, i.e., luciferase activity of naive noninfected
9 cells or cells infected with pseudotypes without HCV envelopes.^{1, 12, 13} Background
10 levels of the assay were determined in each experiment. Means \pm SD from at least
11 four independent experiments performed in triplicate are shown. Significant
12 differences in HCVpp entry VC, VA and VL wildtype and mutant variants are
13 indicated by stars (*, $P \leq .05$; **, $P < .001$). Abbreviations: Ctrl - control; HVR -
14 hypervariable region; n.s. - not significant; V - viral variant.

15

16 **Figure S2. Positions 447, 458 and 478 modulate binding of envelope**
17 **glycoproteins to CD81 expressed at the cell surface.**

18 Binding of native E1E2
19 complexes expressed from patient-derived cDNAs to Huh7.5 cells with silenced
20 CD81 expression (described in Fig. 3) was detected by flow cytometry. Results are
21 expressed as percentage of E1E2 binding compared to shCD13-Huh7.5 control cells.
22 Means \pm SD from three independent experiments performed in triplicate are shown.
23 Significant differences in binding between variants are indicated by stars (**, $P <$
24 $.001$).

1 **Figure S3. Differences in viral entry are not due to impaired HCVpp production.**

2 (A) Analysis of envelope glycoprotein expression. Protein expression was analyzed
3 by immunoblotting as described in Materials and Methods. Molecular markers (kDa)
4 are indicated on the right. (B) Transfection efficiency during HCVpp production.
5 Transfection efficiency was analyzed for each variant and quantified by determining
6 luciferase expression in HEK 293T producer cells expressed as normalized
7 percentage compared to control transfected cells. (C) Envelope glycoprotein
8 expression in HCVpp. HCVpp were purified as described previously^{1, 2} and subjected
9 to immunoblot as described in panel (A). (D) Lentiviral p24 antigen expression was
10 analyzed by ELISA and is indicated as optical density (O.D.) values at 450 nm.
11 Abbreviations: Da - Dalton; MW - molecular weight; n.s. - not significant.

12

13 **Figure S4. Binding of neutralizing anti-E2 HMAb CBH-23 to patient derived-**
14 **envelope glycoproteins expressed on HCVpp as capture antigens in an ELISA.**

15 HCVpp expressing envelope glycoproteins of variants VL, VA, VC, VLVA₄₄₇ and
16 VLVC₄₅₈₊₄₇₈ were used as capture antigens on GNA-coated ELISA plates. Control
17 (Ctrl) pseudoparticles with absent HCV envelope glycoprotein expression and
18 recombinant soluble E2 (sE2 derived from strain H77)¹⁴ served as negative and
19 positive controls, respectively. Anti-E2 CBH-23 reactivity was detected as described
20 in supplementary Materials and Methods and is indicated as optical density (O.D.)
21 values at 450 nm. Means \pm SD from one representative experiment are shown.

22

23 **Figure S5. Distribution of residues at positions 447, 458 and 478 of HCV E2**
24 **sequences in the European HCV databases.** Distribution of residues at positions

25 447, 458 and 478 for HCV complete E2 sequences from all subtypes (black) and
26 from subtype 1b only (white) within the European Hepatitis C Virus databases⁷,

1 (<http://euhcvdb.ibcp.fr>). F and S are the predominant residue at positions 447 and
2 458 (F447: 98.4%, 1b: 96.2%; S458 all: 94%, 1b: 90.3%). The position 478 is
3 variable (it belongs to HVR2) but R (all: 2.4% for, 1b: 10.8%) is more frequent than C
4 (all: 0.2%, 1b: 0.9%).

A.

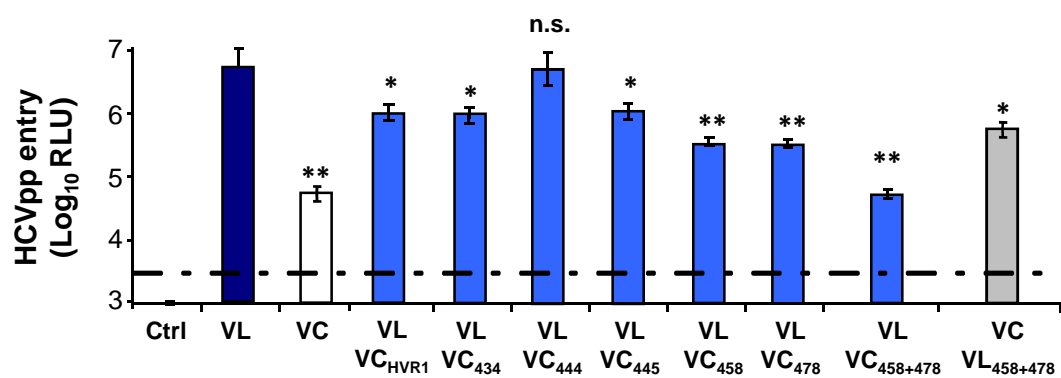

B.

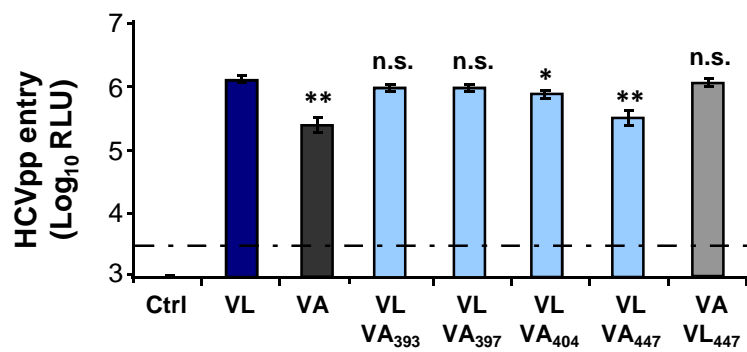

Figure S1

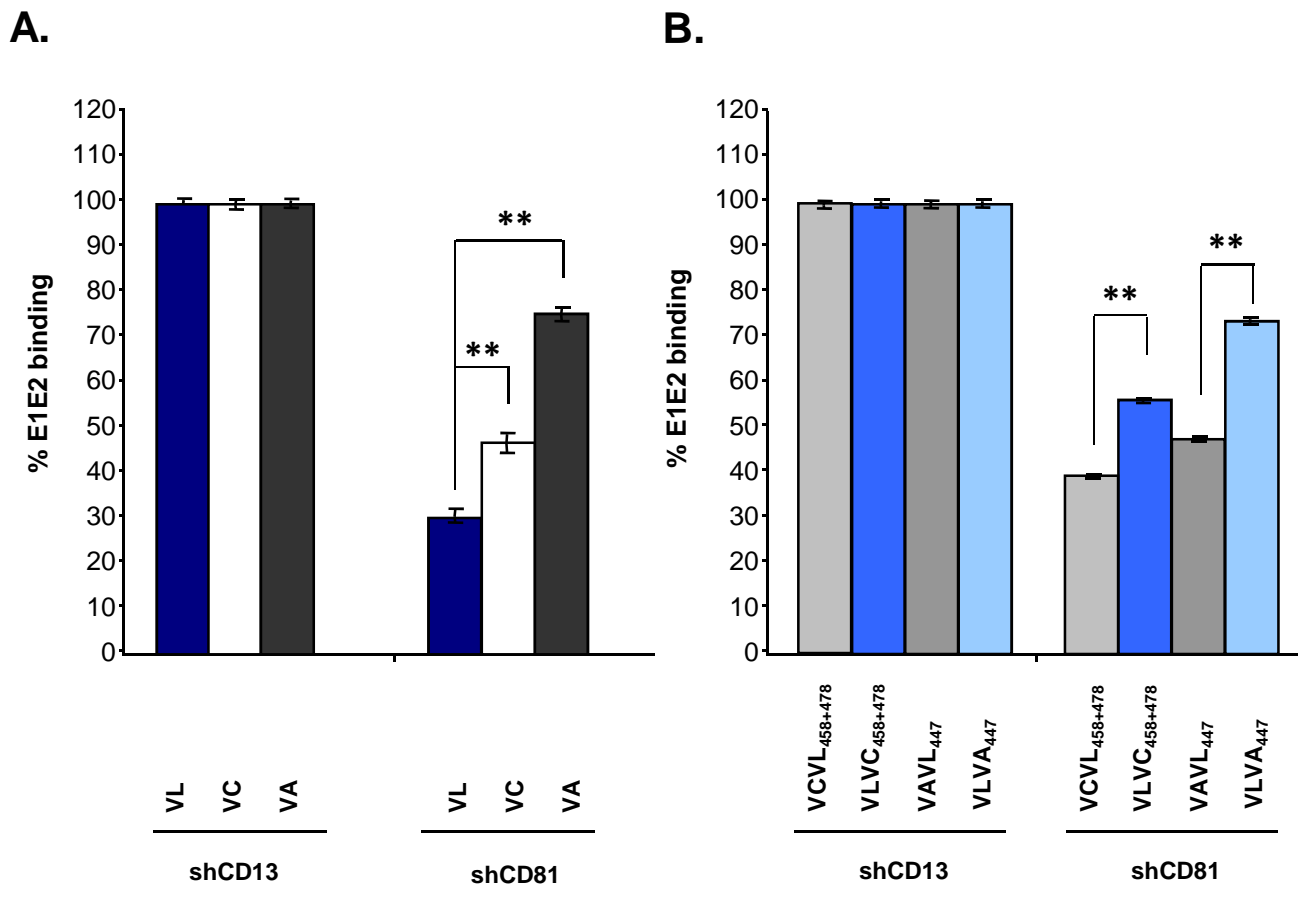

Figure S2

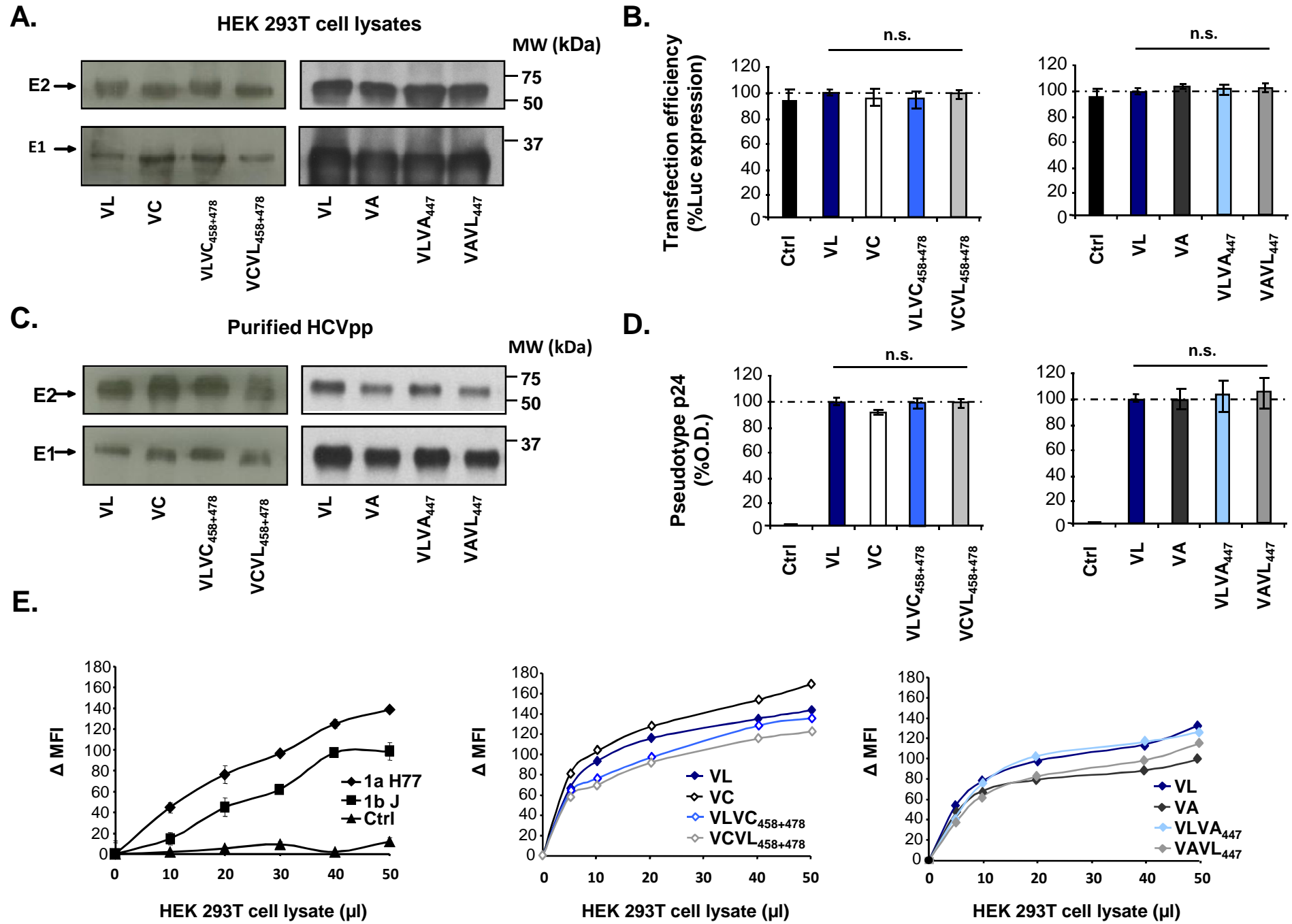

Figure S3

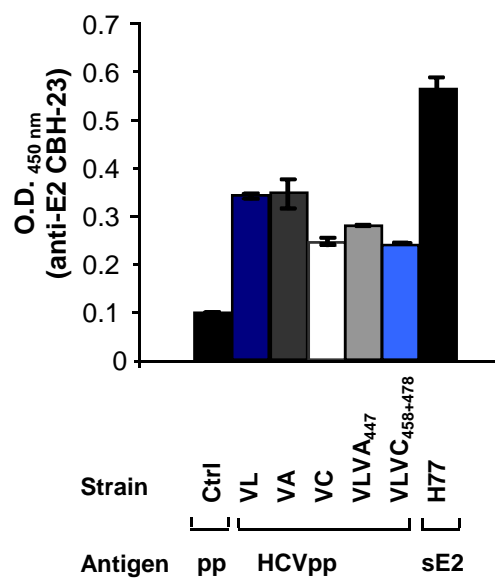

Figure S4

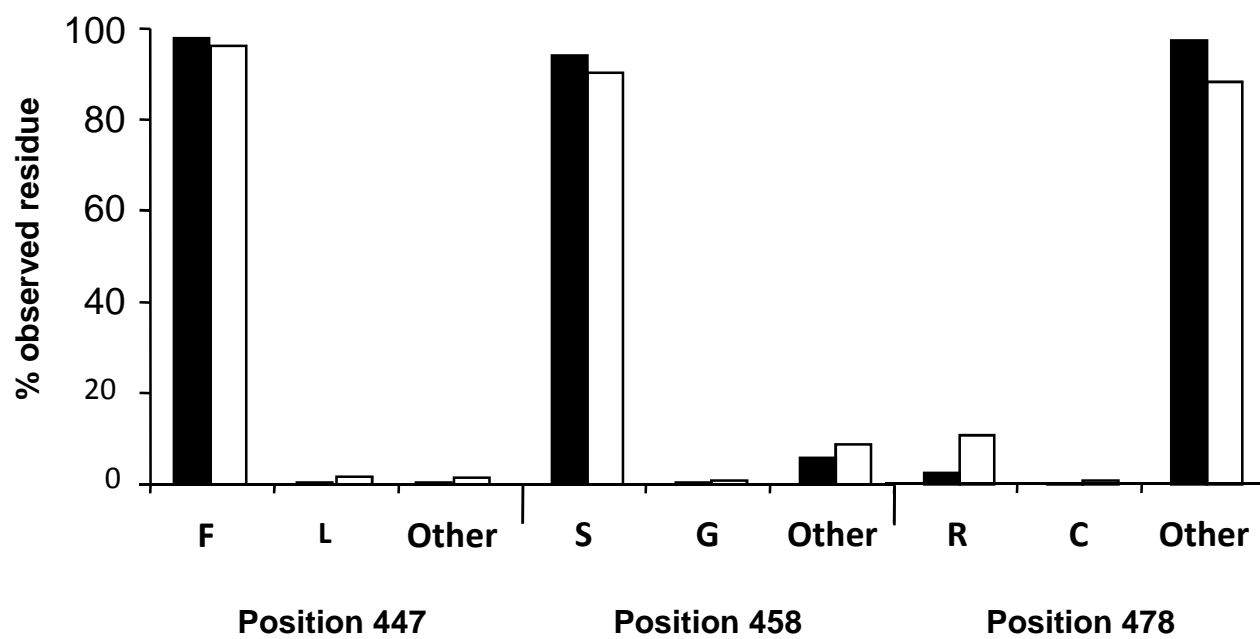

Figure S5

*Revised PDF Manuscript with Figures (No Tracked Changes)

[Click here to download Revised PDF Manuscript with Figures \(No Tracked Changes\): GASTRO D-11-01111.R2 Manuscript_140312 no tr](#)

This piece of the submission is being sent via mail.