



HAL
open science

Effect of CYP2C19 polymorphism on nelfinavir to M8 biotransformation in HIV patients.

Déborah Hirt, France Mentré, Agnès Tran, Elisabeth Rey, Solange Auleley, Dominique Salmon, Xavier Duval, Jean-Marc Tréluyer, Cophar2 Anrs Study Group

► **To cite this version:**

Déborah Hirt, France Mentré, Agnès Tran, Elisabeth Rey, Solange Auleley, et al.. Effect of CYP2C19 polymorphism on nelfinavir to M8 biotransformation in HIV patients.. *British Journal of Clinical Pharmacology*, 2008, 65 (4), pp.548-57. 10.1111/j.1365-2125.2007.03039.x . inserm-00383731

HAL Id: inserm-00383731

<https://inserm.hal.science/inserm-00383731v1>

Submitted on 13 May 2009

HAL is a multi-disciplinary open access archive for the deposit and dissemination of scientific research documents, whether they are published or not. The documents may come from teaching and research institutions in France or abroad, or from public or private research centers.

L'archive ouverte pluridisciplinaire **HAL**, est destinée au dépôt et à la diffusion de documents scientifiques de niveau recherche, publiés ou non, émanant des établissements d'enseignement et de recherche français ou étrangers, des laboratoires publics ou privés.

Effect of CYP2C19 polymorphism on nelfinavir to M8 biotransformation in HIV patients.

D. Hirt ^{a,b}, F. Mentré ^{c,d}, A. Tran ^a, E. Rey ^a, S. Auleley ^c, D. Salmon ^e, X. Duval ^{c,f,g}, J.M. Tréluyer ^{a,b}, and the COPHAR2- ANRS study group.

^a Service de Pharmacologie Clinique, AP-HP, Hôpital Cochin-Saint-Vincent-de-Paul, Université Paris - Descartes ^b EA3620, Université Paris - Descartes ^c INSERM, U738, 75018 Paris, France; Université Paris 7, UFR de Médecine – site Bichat, 75018 Paris, France, ^d UF de Biostatistiques and ^f Service des maladies infectieuses B and ^g Centre d'Investigation Clinique, AP-HP, Hôpital Bichat, 75018, Paris, France and ^e AP-HP, Service de médecine interne, Hôpital Cochin-Saint-Vincent-de-Paul, Université Paris - Descartes.

Key words: HIV, nelfinavir, CYP2C19, pharmacokinetics, NONMEM.

Word count: 3704

Number of figures: 4

Number of tables: 3

* Corresponding author:

Déborah Hirt, Unité de Recherche clinique, Hôpital Tarnier, 89 rue d'Assas, 75006 Paris, deborah.hirt@univ-paris5.fr, tel : +33158412884 Fax : +33158411183

WHAT IS ALREADY KNOWN ABOUT THIS SUBJECT

Nelfinavir is an HIV protease inhibitor, substrate of the transporter P-glycoprotein and metabolized via CYP2C19, CYP3A4 and CYP3A5 enzymes. Pharmacokinetic studies showed a wide interindividual variability of nelfinavir concentrations, some of this variability may be caused by variant drug metabolism or transporter genes. For CYP3A4*1B and CYP3A5*3 polymorphism, results from 3 studies were in agreement, showing no difference in nelfinavir concentrations between patients with these different genotypes. However, for MDR1 and CYP2C19 polymorphism, contradictory studies were found, showing either no impact on nelfinavir concentration or modified concentrations which could influence virologic response.

WHAT THIS STUDY ADDS –

Patients with an *1/*2 or *2/*2 genotype for CYP2C19 had a nelfinavir to M8 biotransformation divided by 2 compared to *1/*1 patients. We did not evidence any influence of MDR1 polymorphism on nelfinavir absorption.

Abstract

Aims : To evaluate the effect of CYP2C19 polymorphism on nelfinavir and M8 pharmacokinetic variability in HIV infected patients and to study the link between pharmacokinetic exposure and short term efficacy and toxicity. **Methods:** Nelfinavir (n=120) and M8 (n=119) concentrations were measured in 34 protease inhibitor naive-patients. Two weeks after initiating the treatment, blood samples were taken before, 1, 3 and 6 hours after drug administration. Genotyping for CYP3A4, 3A5, 2C19 and MDR1 was performed. A population pharmacokinetic model was developed to describe nelfinavir-M8 concentration time-courses and to estimate inter-patient variabilities. The influence of individual characteristics and genotypes were tested using a likelihood ratio test. Estimated mean (C_{mean}), maximal (C_{max}) and trough (C_{trough}) nelfinavir and M8 concentrations were correlated to short term virological efficacy and tolerance using Spearman nonparametric correlation tests. **Results:** A one-compartment model with first-order absorption, elimination and metabolism to M8 best described nelfinavir data. M8 was modelled by an additional compartment. Mean pharmacokinetic estimates and the corresponding inter-subject variabilities were: absorption rate 0.17 h^{-1} (99%), absorption lag time 0.82 h, apparent nelfinavir total clearance 52 L/h (49%), apparent nelfinavir volume of distribution 191 L, M8 elimination rate constant 1.76 h^{-1} and nelfinavir to M8 $\frac{CL_m}{V_m}$ 0.39 h^{-1} (59%) in *1/*1 patients and 0.20 h^{-1} in *1/*2 or *2/*2 patients for CYP2C19*2. Nelfinavir C_{mean} was positively correlated to glycemia and triglycerides increases ($p=0.02$, $p=0.04$). **Conclusions:** The rate of metabolism of nelfinavir to M8 was reduced by 50% in patients with *1/*2 or *2/*2 genotype for CYP2C19 compared to those patients with *1/*1 genotype.

Introduction

Nelfinavir is a protease inhibitor commonly used as a part of the highly active antiretroviral therapy for human immunodeficiency virus infected patients. The use of protease inhibitor-based regimen led to substantial decrease in viral load and restoration of immune function in most HIV-positive individuals, permitting a decline in death rates, and reductions in the incidence of opportunistic infections [1, 2]. Nelfinavir bioavailability is between 70 and 80 % when administered with food [3]. In the intestine, P-glycoprotein (P-gp) restricts the entry into the body of nelfinavir which is a substrate of this transporter [4]. The volume of distribution is 2 to 7 L/kg of bodyweight. Nelfinavir is metabolized into the active metabolite hydroxyl-tert-butylamide (M8) via the CYP2C19 enzyme, and both drugs are metabolized via CYP3A4 [5, 6]. Nelfinavir is the only HIV protease inhibitor that has an active metabolite (M8) present in potentially therapeutic concentrations [6].

There is a wide interindividual variability in the disposition of this drug, and some of this variability may be caused by variant drug metabolism or transporter genes. Some studies were already performed to study the impact of CYP3A4, CYP3A5, CYP2C19 and MDR1 polymorphism on nelfinavir pharmacokinetics. A single-nucleotide polymorphism in the 5' regulatory region of CYP3A4 gene (A-392 G) named CYP3A4*1B is the most common variant; it has been associated in vitro with enhanced CYP3A expression [7]. The CYP 3A5*3 polymorphism (A6986 G) leads to an inactive truncated protein [8]. However Fellay et al. [9], Saitoh et al. [10] and Haas et al. [11] did not evidence any differences in nelfinavir concentrations between patients with these different genotypes. Concerning the effect of MDR1 polymorphism, conflicting results have been found. Two single nucleotide

polymorphism in MDR1-gene G2677A/T in exon 21, and C3435T in exon 26 were shown to be associated with variation in P-gp expression. Fellay et al. [9] showed an increase in median nelfinavir concentration for patients MDR1 3435 from TT, CT to CC genotypes. Saitoh et al. [10] found that children with CT genotype for MDR1 3435 had higher 8h postdose nelfinavir concentration compared to those with other genotypes. However Haas et al. [11] did not evidence any influence of the MDR1 polymorphism in exon 26 and 21 on nelfinavir AUC. For CYP2C19 gene, CYP2C19*2 (G681A point mutation in exon 5) is the most common variant in Caucasian, which has no enzyme activity. Haas et al. [11] found in 348 HIV infected adults, that patients *1/*2 (AG) or *2/*2 (AA) had significantly higher nelfinavir and nelfinavir plus M8 AUC_{0-12h} than *1/*1 (GG) genotype and tended to have a better virologic response. However Fellay et al. [9] in 123 adults, Saitoh et al. [10] in 71 children and Burger et al. [12] in 24 adults did not find any effect of the CYP2C19 genotype on nelfinavir concentrations in plasma.

The aims of this study were to evaluate the influence of genetic polymorphism on pharmacokinetic parameters (MDR1 on absorption, CYP2C19 on nelfinavir to M8 biotransformation and CYP3A4 on nelfinavir and M8 metabolism) and to correlate concentrations to short term virological efficacy and toxicity.

Methods

Patients

The COPHAR2-ANRS 102 study was an open, multicenter, prospective trial of HIV1 infected adults who started a treatment with an antiretroviral combination of at least three drugs : 2 nucleoside reverse transcriptase inhibitors plus one protease inhibitor;

either nelfinavir, or indinavir or lopinavir. In our group, all patients were administered nelfinavir.

Patients older than 18 years, infected by HIV-1, protease inhibitor-naïve were eligible. The Ethical Review Committee of the Bicêtre Hospital, Paris, France reviewed and approved the study protocol. All participants provided written informed consent.

These adults were administered nelfinavir as 1250 mg twice daily (BID), only one patient had 1500 mg twice daily and one had a 625 mg twice daily. Nelfinavir was given using the new formulation of 625 mg tablets [13]. A 250 mg tablet was added for the patient who received 1500 mg BID. A blood sample was taken for genotype before initiating the treatment and two weeks later patients underwent 4 blood samplings, before, 1, 3 and 6 hours after drug intake for pharmacokinetic analysis. For each patient, time elapsed between administration and sampling times were carefully recorded. For modeling, we assumed that patients were at steady state with a dosing interval τ of 12 h. The trough concentration was the concentration measured the day before drug intake and the 3 other concentrations were measured after drug intake.

Short term efficacy was studied using HIV RNA levels at day 0 and week 2. Short term tolerance (fasten cholesterol, triglyceride and glycemia) was analyzed, based on measurements performed 4 weeks before and 4 weeks after initiating the treatment. A questionnaire for adherence was also used. One adherence covariate was analyzed, corresponding to the yes/no answer at the question “During the last 4 days, did you forget or delay deliberately or not your antiretroviral drug intake?”

Analytical method

Nelfinavir and M8 plasma concentrations were measured by specific high performance liquid chromatography. The 4 participant laboratories were cross-validated before starting the study. Results of the blind interlaboratory quality control at three concentrations for nelfinavir and for M8 were within 15% of the target values from medium and high values and within 20% for low values. Lower limits of quantification (LOQ) were 100 ng/mL for nelfinavir and 25 ng/mL for M8 depending on the method used.

Genotyping

All Genotypes were performed in the same laboratory. Total deoxyribonucleic acid (DNA) was extracted from plasma samples by use of the QIAamp DNA Blood Mini Kit (Qiagen, Courtaboeuf, France). Genotyping for CYP2C19*2 was performed by a polymerase chain reaction–restriction fragment length polymorphism (PCR-RFLP) method with allele-specific primers, as described by de Morais et al. [14]. Genotyping for CYP3A4*1B was determined by polymerase chain reaction (PCR) followed by direct sequencing. PCR was performed by use of a GenAmp PCR System 9700 (Applied Biosystems, Courtaboeuf, France) according to a previously published method [15]. Amplified DNA was purified by use of the QiaQuick DNA Purification System (Qiagen) and sequenced by use of BigDye Terminator chemistry and an ABI PRISM 3100 genetic analyzer (Applied Biosystems). Genotyping of CYP3A5*3 and *6 was performed by real-time polymerase chain reaction by use of TaqMan MGB probe technology (Applied Biosystems). MDR1 polymorphisms in exons 21 and 26 were determined by use of previously published methods [16]. For each genotyping analysis, at least 2 positive controls were used: 1 homozygous for the wild-type allele

and 1 heterozygous and, when available, 1 homozygous for the mutated allele. These controls are DNAs that have been sequenced.

Modelling strategy and population pharmacokinetic model

Data were analyzed using the nonlinear mixed effect modelling software program NONMEM (version V, level 1.1, double precision) with the DIGITAL FORTRAN compiler [17]. The first-order conditional estimation (FOCE) with interaction method was used. A one-compartment model with first-order absorption, elimination and metabolism to M8, best described nelfinavir data. M8 was modelled by an additional compartment (Fig 1). Parameters of the model were the bioavailability (F), the absorption rate constant (k_a), the absorption lag time (Tlag), the volumes of distribution of nelfinavir and M8 (V and V_m), the total elimination rate constant for nelfinavir (k corresponding to k_e+k_m in Fig 1), the metabolic rate constant (k_m) describing the nelfinavir to M8 biotransformation, and the elimination rate constant for M8 (k_{em}). Since nelfinavir was orally administered, only k_a , Tlag, V/F and k were identifiable for nelfinavir. For M8, since no urinary concentration data were available, and because no literature data were used to fix V_m/F , only Fk_m/V_m and k_{em} could be determined. Therefore, the model was reparametrized using an apparent clearance for nelfinavir ($CL_T/F = k \times V/F$) and an apparent nelfinavir to M8 biotransformation clearance ($CL_m/F = k_m \times V/F$). The vector of identifiable parameters used in the population analysis was therefore k_a , Tlag, CL_T/F , V/F, $\frac{CL_m}{V_m}$ and k_{em} .

The following equations describe nelfinavir and M8 plasma concentrations:

$$[N] = \frac{k_a \times D}{\frac{V}{F} \times \left(k_a - \frac{CL_T/F}{V/F} \right)} \times \left(\frac{e^{-\frac{CL_T/F}{V/F} \times t}}{1 - e^{-\frac{CL_T/F}{V/F} \times \tau}} - \frac{e^{-k_a \times t}}{1 - e^{-k_a \times \tau}} \right)$$

$$[M8] = \frac{F \times k_a \times D \times \frac{CL_m}{V_m}}{V} \times \left(\frac{e^{-\frac{CL_T/F}{V/F} \times t}}{\left(1 - e^{-\frac{CL_T/F}{V/F} \times \tau} \right) \left(k_a - \frac{CL_T/F}{V/F} \right) \left(k_{em} - \frac{CL_T/F}{V/F} \right)} + \frac{e^{-k_a \times t}}{\left(1 - e^{-k_a \times \tau} \right) \left(\frac{CL_T/F}{V/F} - k_a \right) (k_{em} - k_a)} + \frac{e^{-k_{em} \times t}}{\left(1 - e^{-k_{em} \times \tau} \right) \left(\frac{CL_T/F}{V/F} - k_{em} \right) (k_a - k_{em})} \right)$$

with $t = \text{delay} - T_{lag}$ if $\text{delay} > T_{lag}$ and $t = \text{delay} - T_{lag} + \tau$ if $\text{delay} < T_{lag}$, where t is the calculated time between start of absorption and sampling, T_{lag} is the estimated absorption lag time, delay is the recorded time elapsed between drug administration and blood sampling and τ is the time interval between 2 administrations.

When nelfinavir or M8 concentrations were below the LOQ, we set them to half of the LOQ. Several error models were investigated (i.e. multiplicative and additive error models) to describe residual variability. Proportional model was used for inter-subject variability (ISV). Data for nelfinavir and M8 were then fitted jointly. Only significant ISVs on pharmacokinetic parameter were kept, i.e. a minimum of 3.84 unit decrease using a likelihood ratio test in a backward elimination procedure. From the POSTHOC option of NONMEM applied on this basic model, Empirical Bayes estimates of each parameter were obtained. The effect of each patient covariate was tested on these estimates, using Spearman nonparametric correlation test for

continuous covariates such as age, bodyweight, body mass index, albumine and orosomucoid or using the Wilcoxon test for categorical ones such as sex, CDC stage of virus infection (C/non C), genotypes (CYP3A4*1B, CYP3A5*3 and *6, CYP2C19*2, MDR1 exon21, MDR1 exon 26), adherence and the co-administration of combivir[®] (drug combining AZT and 3TC). Co-medication was analyzed in 2 classes: patients who were taking combivir[®] against other co-medications. Genetic polymorphism was analyzed in two different ways: wild type against heterozygote plus homozygote mutated or wild type plus heterozygote against homozygote mutated. Covariates that were found to have an effect on a pharmacokinetic parameter with a p value lower than 0.10, were retained for inclusion in the population model. They were then added one by one to the basic pharmacokinetic model, the most significant at first. Continuous covariates (CO) were tested according to the following equation, using CL for example, $CL = \theta_{CL} \times \left(\frac{CO}{\text{median}(CO)} \right)^{\beta_{CO}^{CL}}$, where θ_{CL} is the typical value of clearance for a patient with the median covariate value and β_{CO}^{CL} is the estimated influential factor for the continuous covariate. Categorical covariates (CA) were tested as, $CL = \theta_{CL} / (1 + \beta_{CA}^{CL} \times CA)$ where CA=0 or 1. Patients with a missing value for a covariate retained during the first statistical analysis were excluded of the covariate population modeling. The basic model was fitted again with the patients with all covariate values and the covariate could then be tested.

A covariate was kept if its effect was biologically plausible; it produced a minimum reduction of 3.84 in the objective function value (OFV) and a reduction in the variability of the pharmacokinetic parameter, assessed by the associated inter-subject variability. An intermediate model with several covariates was then obtained. All the selected covariates were added one by one and kept if responding to the cited

3 criteria. At the end of this ascendant modeling, the final model was obtained. A backward elimination phase was finally performed by deleting each covariate from the final model in order to calculate the p value, using a likelihood ratio test.

For evaluation of the goodness-of-fit, the following graphs were performed: observed and predicted concentrations versus time, observed concentrations vs population predictions, weighted residuals vs time and weighted residuals vs predictions. Similar graphs using individual predictive POSTHOC estimation were displayed. Diagnostic graphics were obtained using the R program [18].

Validation.

Nelfinavir and M8 steady-state concentration profiles were simulated and compared with the observed data thanks to visual predictive check in order to evaluate the performance of the model. More precisely, the vector of pharmacokinetic parameters from 1000 patients was simulated using the final model. Each vector parameter was drawn in a normal distribution with a variance corresponding to the ISV previously estimated. A simulated residual error was added to each simulated concentration. The simulations were performed using NONMEM. The 5th, 50th and 95th percentiles of the simulated concentrations at each time were then overlaid on the observed concentration data using R program and a visual inspection was performed.

Links between concentrations and short term response / toxicity.

For each patient, mean ($C_{\text{mean},N}$), maximal ($C_{\text{max},N}$) and trough ($C_{\text{trough},N}$) nelfinavir plasma concentrations and the sum of nelfinavir + M8 trough ($C_{\text{trough},NM8}$) plasma concentrations were derived from the estimated individual pharmacokinetic

parameters. The efficacy was studied following the difference in log viral load between the day of initiation treatment and week 2. The significance of the viral load decrease was first tested using a Wilcoxon non-parametric paired test. With respect to efficacy, the links between $C_{\text{trough},N}$, $C_{\text{trough},NM8}$ and the difference in HIV-1 RNA level between day 0 and Week 2 was evaluated using correlation Spearman tests. A Wilcoxon non-parametric test was also performed on decrease in viral load between patients having or not a C_{trough} below the lower limit of therapeutic range (1500 ng/mL, limit used in the COPHAR 2-ANRS 111 trial).

Toxicity was analyzed from the difference between 4 weeks after and before treatment initiation in total cholesterol, high density lipoprotein cholesterol, triglyceride, glycemia and from appearances of diarrheas (grade 2) between treatment initiation and week 4. The significance of these differences was tested using a Wilcoxon non-parametric paired test. Then we performed correlation Spearman tests between $C_{\text{mean},N}$, $C_{\text{max},N}$, $C_{\text{trough},N}$ and difference in total cholesterol, high density lipoprotein cholesterol, triglyceride and glycemia. We also used Wilcoxon non-parametric tests to compare these differences between patients having or not a C_{trough} over the upper limit defined in the therapeutic index (5500 ng/mL, limit used in the COPHAR 2-ANRS 111 trial).

We also assessed the relationship between the genetic polymorphisms remaining in the final population model and $C_{\text{mean},N}$, $C_{\text{max},N}$, $C_{\text{trough},N}$ and the relationship between these genetic polymorphisms and the efficacy and toxicity outcomes previously described, using Wilcoxon non-parametric tests.

Results

Demographic data

Thirty four patients were included in the nelfinavir arm. All these patients were available for pharmacokinetic evaluation. A total of 120 nelfinavir concentrations and 119 M8 concentrations were collected. Table 1 summarizes patient characteristics: age, bodyweight, BMI, orosomucoid, albumin, sex, CDC stage, concomitant medications with combivir ®, good adherence and genetic polymorphism for genes MDR1 (exon 21 and 26), CYP2C19, CYP3A4, CYP3A5.

Population pharmacokinetics : Nelfinavir-M8 pharmacokinetic model building.

One nelfinavir and 13 M8 concentrations were lower than the LOQ, so they were set to half of the LOQ. Inter-subject variability was described by multiplicative model. The available data were not sufficient to estimate inter-subject variability for T_{lag} , V/F and k_{em} , and fixing the variance of these random effects to zero had no influence on the objective function values (OFV). Residual variabilities were best described by proportional error model. The addition of a correlation between nelfinavir and M8 residual variabilities ($r=0.37$ (40%)) decreased OFV by 8.45 units.

Covariates were first tested on Bayesian Empiric estimates of K_a , CL/F and CL_m/V_m from the basic model. The most significant covariate was for CYP2C19 genotypes on CL_m/V_m , a significant difference was found between wild type ($*1/*1$, GG) and other patients ($*1/*2$, AG or $*2/*2$, AA) ($p=0.01$). The coadministration of combivir ® increased significantly k_a ($p=0.02$). Four patients did not have a genotype for the CYP2C19, so they were excluded from the covariate modeling and a basic model was fitted again with the remaining 30 patients. Then, CYP2C19 genotype was first

added on $\frac{CL_m}{V_m}$ as an inhibitory effect for patients with the mutation. The effect was significant resulting in 7.03 units decrease in the OFV, in a 13 % decrease in the inter-subject variability of CL_m/V_m , and a better correlation between observed and predicted concentrations. The coefficient $\beta_{\frac{CL_m}{V_m}, CYP2C19}$ was equal to 0.98, meaning that the rate of metabolism of nelfinavir to M8 was reduced by 50% in patients with *1/*2 or *2/*2 genotype for CYP2C19 compared to those patients with *1/*1 genotype.

Then combivir® coadministration was added on K_a in this intermediate model, but no significant effect was found. Figure 2 displays nelfinavir and M8 observed and predicted plasma concentrations at week 2 versus time, for CYP2C19 wild type (patients GG for CYP2C19*2) and for CYP2C19 mutated patients (AG or AA for CYP2C19*2). Table 2 summarizes the final population pharmacokinetic estimates in 30 patients.

Model performance. Final model performance were appreciated by comparing population predicted and individual predicted to observed plasma concentrations and population weighted residuals versus predicted concentrations and versus time for nelfinavir and for M8. Visual predictive check of the final population PK model (Fig 3) showed the comparison between the 5th, 95th and 50th predicted percentiles for the 1000 simulations and the observed concentrations of nelfinavir. This evaluation method provided good proof for the model adequacy.

Links between concentrations and short term response / toxicity.

The values of the following parameters: HIV-1 RNA level, total cholesterol, HDL cholesterol, glycemia and triglycerides were available for 30 patients as basal, and as 2 or 4 weeks treatment which allowed to calculate their variation and to test the significance of the difference.

The viral load decreased significantly after 2 weeks of treatment (table 3). However the significant decrease in HIV-1 RNA between day 0 and Week 2 was not correlated to $C_{\text{trough},N}$, nor to $C_{\text{trough},NM8}$ and was not different between patients with a C_{trough} below or above the lower limit of therapeutic range of 1500ng/ml.

Total cholesterol increased significantly after 4 weeks of treatment, contrarily to HDL cholesterol (Table 3). Nelfinavir $C_{\text{trough},N}$, $C_{\text{max},N}$ and $C_{\text{mean},N}$ were not significantly correlated with total nor with HDL cholesterol evolution. Glycemia increased after 4 weeks of treatment ($p=0.05$) and its evolution was significantly positively correlated to nelfinavir $C_{\text{mean},N}$ and $C_{\text{trough},N}$ ($p=0.02$ and $p=0.03$). Although triglycerides increase was not significant, its evolution was significantly positively correlated to nelfinavir $C_{\text{mean},N}$ ($p=0.04$) (Fig 4). No patient had a C_{trough} over the therapeutic index upper limit of 5500 ng/mL. No grade 2 diarrhea was recorded.

We could not evidence any significant differences in $C_{\text{trough},N}$ $C_{\text{trough},NM8}$, nor in short term efficacy or toxicity between patients *1/*1 and patients *1/*2 or *2/*2 for CYP2C19 gene.

Discussion

The concentrations of nelfinavir and of M8 were satisfactorily described by a one-compartment model with first-order absorption and elimination for nelfinavir with an additional compartment for M8 linked with a first order rate constant. This joint model

was already used in adults [19, 20]. The following results support the use of this pharmacokinetic model:

Nelfinavir mean plasma clearance was consistent with previously reported values: $CL_T/F = 52$ L/h compared to 37.3, 35.5 and 44.9 L/h obtained in Panhard et al. [19], in our previous [20] and in Jackson et al. [21] studies.

Nelfinavir to M8 biotransformation and M8 elimination were consistent with our 2 previous studies (in women and in children [20, 22]) and with Panhard et al. study [19], $CL_m/V_m = 0.39$ h⁻¹ compared to respectively 0.65, 0.58 and 0.36 h⁻¹ and $k_{em} = 1.76$ h⁻¹ compared to 3.3, 1.88 and 1.93 respectively.

Nelfinavir to M8 biotransformation was reduced in patients *1/*2 or *2/*2 for the CYP2C19 genotype compared to the wild type *1/*1 genotype which is consistent with Burger et al. [12] and Haas et al. [11] studies who found a significantly lower M8 to nelfinavir AUC ratio in patients with the mutation than in wild type patients. In our study, no patients had liver dysfunction, and no one was taking concurrent medications that are potential inhibitors of CYP2C19, so the decrease in nelfinavir to M8 biotransformation could only be attributed to CYP2C19 polymorphism.

A major aim of population pharmacokinetics is to determine which measurable pathophysiological factor can cause changes in the dose-concentration relationship. In this study, only the CYP2C19 genotype was found to influence nelfinavir and M8 pharmacokinetics. Nelfinavir is metabolized exclusively by CYP2C19 into M8 [5]. Nelfinavir and M8 are described as being equally active [6]. Haas et al. [11] found in 348 HIV infected adults, that patients *1/*2 or *2/*2 had significantly higher nelfinavir and nelfinavir + M8 AUC_{0-12h} than *1/*1 genotype and tended to have a better virologic response. We could not evidence a significant difference in nelfinavir or

nelfinavir + M8 concentrations between the 2 genotypes. In this study, as we could estimate individual pharmacokinetic parameters, we could quantify the effect of CYP2C19 polymorphism directly on these parameters and have a mechanistic approach of the process. We found that the rate of metabolism of nelfinavir to M8 was reduced by 50% in patients with *1/*2 or *2/*2 genotype for CYP2C19 compared to those patients with *1/*1 genotype. Moreover, as shown in Figure 2, M8 concentrations were lower in patients *1/*2 or *2/*2 than in *1/*1 patients for CYP2C19, whereas nelfinavir concentrations were similar (Figure 2). This suggests an increase in nelfinavir elimination by CYP3A4 which compensate the decreased elimination via CYP2C19. Concerning CYP3A4 and MDR1 genes, in agreement with precedent studies [9, 10, 11], we did not evidence any difference between wild type and mutated groups for nelfinavir and M8 pharmacokinetics.

Powderly et al. [23] showed that change in viral load over the first 4 weeks of treatment was predictive of virological response over 48 weeks of treatment. Hoetelmans et al. [24] in 29 HIV infected, antiretroviral-naïve patients using a quadruple drug regimen (nelfinavir, saquinavir, stavudine and lamivudine) showed that median nelfinavir concentration ratio was positively correlated with the elimination rate constant (k) of HIV-1 clearance (k = slope of the curve describing initial log viral load as a function of time). We could not establish a significant relationship between nelfinavir concentrations and the reduction in HIV RNA level after 2 weeks of treatment in our PI naïve patients. The main difference with Hoetelmans et al. study was that the decrease in HIV RNA was much lower in our study: viral load was divided by 1.80 in 14 days, corresponding to an elimination rate constant for HIV-1 clearance of 0.13 day^{-1} . In Hoetelmans study similar basal viral

load were measured but k was 0.29 day^{-1} , indicating that median viral load was divided by 4 after two weeks of treatment.

Few studies evaluated cholesterol, triglycerides and glycemia early changes as a function of nelfinavir plasma concentrations. As Périard et al. [25] who found that total cholesterol increased slightly but significantly ($1.2 \pm 0.2 \text{ mmol/L}$) after 4 weeks of treatment in 21 HIV-1 infected patients, we found a significant increase in total cholesterol in our 30 patients. However no relationship could be evidenced between this increase and nelfinavir plasma concentration. Similarly Reijers et al did not find any relationship between elevated cholesterol and plasma nelfinavir drug exposure, although the occurrence of elevated cholesterol was frequent i.e in 35% of their patients on quadruple regimen (stavudine, lamivudine, saquinavir and nelfinavir). Furthermore Reijers et al. [24] found that nelfinavir concentrations were not higher in hypercholesterolemic ($>6.2 \text{ mmol/L}$), nor in hypertriglyceridemic ($>4.5 \text{ mmol/L}$) patients. In our study, no patient had a triglycerides rate above 4.5 mmol/L , but a significant positive correlation was found between triglycerides rate and nelfinavir $C_{\text{mean},N}$ ($p=0.04$). We also found that nelfinavir $C_{\text{mean},N}$ and $C_{\text{trough},N}$ were significantly positively correlated with glycemia evolution (between 4 weeks after and before initiating the treatment) ($p=0.02$ and $p=0.03$).

The rate of metabolism of nelfinavir to M8 was reduced by 50% in patients with $*1/*2$ or $*2/*2$ genotype for CYP2C19 compared to those patients with $*1/*1$ genotype, without any significant modifications on nelfinavir trough concentrations, efficacy or toxicity. In these Pi-naïve patients, efficacy could not be related to nelfinavir plasma concentrations but triglycerides and glycemia increased with nelfinavir exposure.

For this analysis, Déborah Hirt was supported by a CRES (contrat de recherche stratégie) from INSERM.

Acknowledgments:

The authors thank the study participants and the participating clinicians at each site, Agence Nationale de Recherche sur le SIDA (ANRS, essai 111) for financial support, and Roche for providing nelfinavir, Dr Agnes Certain for organizing the drug supply to all centers.

Steering committee: principal investigator: D. Salmon-Céron, X. Duval, Statistics: F. Mentré; other members S. Auleley, M. Biour, M.J. Comroy, B. Diquet, C. Goujard, C. Katlama, C. Lascoux, M. Legrand, A. Métro, G., Peytavin, E. Rey, A.M. Taburet, J.M. Tréluyer.

Safety committee: S. Auleley, M. Biour, A. Métro, C. Lascoux, D. Salmon-Céron.

Pharmacological monitoring committee: X. Duval, E. Rey, J.M. Tréluyer.

Indépendant committee: Pr Rouzioux, Dr Piketti, Mr Flandre, Dr Zenut, Dr Marquet.

Clinical centers : Dr Bentata, Dr Mansouri, Mme Touam, Pr Sereni, Dr Lascoux, Dr Pintado, Dr Goujard, Mme Mole, Dr Sellier, Dr Bendenoun, Dr Rami, Mme Parrinello, Dr Jeantils, Mme Tassi, Pr Vittecoq, Dr Teicher, Mme Mallet, Pr Dupont, Dr Lahoulou, Soeur AZAR, Pr Rozembaum, Dr Slama, Dr Naït-Ighil, Baakili, Courtial-Destembert, Pr Vildé, Pr Leport, Dr Duval, Dr Al Kaied, Pr Salmon, Dr Spiridon, Dr Lesprit, Mme Chesnel, Pr Katlama, Dr Schneider, Mme Schoen, Pr Molina, Dr Ponscarne, Dr Colin de Verdière, Pr Morlat, Dr Bonarek, Dr Joly, Dr Ralaimazava, Mme Meridda, Mme Le Gac, Pr Raffi, Dr Allavena, Mr Hüe, Mme Sicot, Dr Perré, Dr Leautez, Dr Aubry, Mme Suaud, Pr Dellamonica, Dr Rahelinirina, Pr Michelet, Dr Bouvier, Pr Bazin, Dr Goubin, Pr May, Dr Boyer, Pr Rouveix, Dr Dupont, Mme Berthé

Pharmacological centers : Dr Rey, Dr Tréluyer, Dr Abbara, Dr Audoul, Dr Tran, Dr Sauvageon, Dr Poirier, Dr Taburet, Dr Vincent, Dr Aymard, Dr Peytavin, Dr Lamotte, Dr Dailly, Dr Garraffo, Dr Lavrut, Dr Molimard, Dr Titier, Dr Tribut, Dr Hulin, Dr Huet, Dr Delhotal, Dr Hoizey

Virological centers : Dr Alloui, Dr Baazia, Dr Palmer, Dr Labaky, Dr Idri, Dr Mazon, Dr Bensidhoum, Dr Beaulieux, Dr Burgard, Dr Zatlá, Dr Chambs, Dr Beniken, Dr Bouvier-Alias, Dr Miladi, Dr Gurlain, Dr Amellal, Dr Garrigue, Dr Pellegrin, Dr Ferré, Dr Garnier, Dr Poirier, Dr Cottalorda, Mme Benhamou, Dr Maillard, Dr Venard, Dr Soussan

Monitoring centers: S. Auleley, E. Marcault, F. Mentré.

Statistics: E. Bougen, F. Mentré, X. Panhard.

References

- 1- Palella FJ Jr, Delaney KM, Moorman AC, Loveless MO, Fuhrer J, Satten GA, Aschman DJ, Holmberg SD. Declining morbidity and mortality among patients with advanced human immunodeficiency virus infection. HIV Outpatient Study Investigators. *N Engl J Med* 1998; 338: 853–860.
- 2- Hammer SM, Squires KE, Hughes MD, Grimes JM, Demeter LM, Currier JS, Eron JJ Jr, Feinberg JE, Balfour HH Jr, Deyton LR, Chodakewitz JA, Fischl MA. A controlled trial of two nucleoside analogues plus indinavir in persons with human immunodeficiency virus infection and CD4 cell counts of 200 per cubic millimeter or less. *N Engl J Med* 1997; 337: 725–733.
- 3- Viracept package insert, 2001; Agouron Pharmaceuticals, La Jolla, Calif
- 4- Kim RB, Fromm MF, Wandel C, Leake B, Wood AJ, Roden DM, Wilkinson GR. The drug transporter P-glycoprotein limits oral absorption and brain entry of HIV-1 protease inhibitors. *J Clin Invest* 1998; 101: 289-94.
- 5- Lillibridge JH, Lee CA, Pithavala YK. The role of polymorphic CYP2C19 in the metabolism of nelfinavir mesylate, in XII Annual Meeting and Exposition of the American Association of Pharmaceutical Scientists; November 1998, San Francisco. Abstract 3035. American Association of Pharmaceutical Scientists, Arlington, VA.
- 6- Zhang KE, Wu E, Patick AK, Kerr B, Zorbas M, Lankford A, Kobayashi T, Maeda Y, Shetty B, Webber S. Circulating metabolites of the human immunodeficiency virus protease inhibitor nelfinavir in humans: structural identification, levels in plasma, and antiviral activities. *Antimicrob Agents Chemother* 2001; 45: 1086-93.

- 7- Tran A, Jullien V, Alexandre J, Rey E, Rabillon F, Girre V, Dieras V, Pons G, Goldwasser F, Tréluyer JM. Pharmacokinetics and toxicity of docetaxel: Role of CYP3A, MDR1, and GST polymorphisms. *Clin Pharmacol Ther* 2006; 79: 570-80
- 8- Hustert E, Haberl M, Burk O, Wolbold R, He YQ, Klein K, Nuessler AC, Neuhaus P, Klattig J, Eiselt R, Koch I, Zibat A, Brockmoller J, Halpert JR, Zanger UM, Wojnowski L. The genetic determinants of the CYP3A5 polymorphism. *Pharmacogenetics* 2001; 11: 773–779.
- 9- Fellay J, Marzolini C, Meaden ER, Back DJ, Buclin T, Chave JP, Decosterd LA, Furrer H, Opravil M, Pantaleo G, Retelska D, Ruiz L, Schinkel AH, Vernazza P, Eap CB, Telenti A; Swiss HIV Cohort Study. Response to antiretroviral treatment in HIV-1-infected individuals with allelic variants of the multidrug resistance transporter 1: a pharmacogenetics study. *Lancet* 2002; 359: 30-6.
- 10-Saitoh A, Singh KK, Powell CA, Fenton T, Fletcher CV, Brundage R, Starr S, Spector SA. An MDR1-3435 variant is associated with higher plasma nelfinavir levels and more rapid virologic response in HIV-1 infected children. *AIDS* 2005; 19: 371-80.
- 11-Haas DW, Smeaton LM, Shafer RW, Robbins GK, Morse GD, Labbe L, Wilkinson GR, Clifford DB, D'Aquila RT, De Gruttola V, Pollard RB, Merigan TC, Hirsch MS, George AL Jr, Donahue JP, Kim RB. Pharmacogenetics of long-term responses to antiretroviral regimens containing Efavirenz and/or Nelfinavir: an Adult Aids Clinical Trials Group Study. *J Infect Dis* 2005; 192: 1931-42.
- 12-Burger DM, Schwietert HR, Colbers EP, Becker M. The effect of the CYP2C19*2 heterozygote genotype on the pharmacokinetics of nelfinavir. *Br J Clin Pharmacol* 2006; 62: 250-2.

- 13-Kaeser B, Charoin JE, Gerber M, Oxley P, Birnboeck H, Saiedabadi N, Banken L. Assessment of the bioequivalence of two nelfinavir tablet formulations under fed and fasted conditions in healthy subjects. *Int J Clin Pharmacol Ther* 2005; 43: 154-62.
- 14-De Morais SMF, Wilkinson GR, Blaisdell J, Meyer UA, Nakamura K, Goldstein JA. Identification of a new genetic defect responsible for the polymorphism of (S)-mephenytoin metabolism in Japanese. *Mol Pharmacol* 1994; 46: 594–8.
- 15-Dally H, Edler L, Jager B, Schmezer P, Spiegelhalder B, Dienemann H, Drings P, Schulz V, Kayser K, Bartsch H, Risch A. The CYP3A4*1B allele increases risk for small cell lung cancer: effect of gender and smoking dose. *Pharmacogenetics* 2003; 13: 607-18.
- 16-Cascorbi I, Gerloff T, Johne A, Meisel C, Hoffmeyer S, Schwab M, Schaeffeler E, Eichelbaum M, Brinkmann U, Roots I. Frequency of single nucleotide polymorphisms in the P-glycoprotein drug transporter MDR1 gene in white subjects. *Clin Pharmacol Ther* 2001; 69: 169-74.
- 17-Beal SL, Sheiner LB. NONMEM user's guide; NONMEM project group. University of California at San Francisco. 1998.
- 18-Ihaka R, Gentleman R. R: a language for data analysis and graphics. *J Comput Graphic Statistics* 1996; 5: 299.
- 19-Panhard X, Goujard C, Legrand M, Taburet AM, Diquet B, Mentré F; COPHAR 1-ANRS study group. Population pharmacokinetic analysis for nelfinavir and its metabolite M8 in virologically controlled HIV-infected patients on HAART. *Br J Clin Pharmacol* 2005; 60: 390-403.

- 20-Hirt D, Treluyer JM, Jullien V, Firtion G, Chappuy H, Rey E, Pons G, Mandelbrot L, Urien S. Pregnancy-related effects on nelfinavir and M8 pharmacokinetics: a population study in 133 women. *Antimicrob Agents Chemother* 2006; 50:2079-86.
- 21-Jackson KA, Rosenbaum SE, Kerr BM, Pithavala YK, Yuen G, Dudley MN. A population pharmacokinetic analysis of nelfinavir mesylate in human immunodeficiency virus-infected patients enrolled in a phase III clinical trial. *Antimicrob Agents Chemother* 2000; 44: 1832-7.
- 22-Hirt D, Urien S, Jullien V, Firtion G, Rey E, Pons G, Blanche S, Treluyer JM. Age-related effects on nelfinavir and M8 pharmacokinetics: a population study with 182 children. *Antimicrob Agents Chemother* 2006; 50: 910-6.
- 23-Powderly WG, Saag MS, Chapman S, Yu G, Quart B, Clendeninn NJ. Predictors of optimal virological response to potent antiretroviral therapy. *AIDS* 1999; 13: 1873-80.
- 24-Hoetelmans RM, Reijers MH, Weverling GJ, ten Kate RW, Wit FW, Mulder JW, Weigel HM, Frissen PH, Roos M, Jurriaans S, Schuitemaker H, de Wolf F, Beijnen JH, Lange JM. The effect of plasma drug concentrations on HIV-1 clearance rate during quadruple drug therapy. *AIDS* 1998; 12: F111-5.
- 25-Periard D, Telenti A, Sudre P, Cheseaux JJ, Halfon P, Reymond MJ, Marcovina SM, Glauser MP, Nicod P, Darioli R, Mooser V. Atherogenic dyslipidemia in HIV-infected individuals treated with protease inhibitors. The Swiss HIV Cohort Study. *Circulation* 1999; 100: 700-5.
- 26-Reijers MH, Weigel HM, Hart AA, Ten Kate RW, Mulder JW, Reiss P, Schuitemaker H, Hoetelmans RM, Weverling GJ, Lange JM. Toxicity and drug exposure in a quadruple drug regimen in HIV-1 infected patients participating in the ADAM study. *AIDS* 2000; 14: 59-67.

Table 1. **Patient characteristics at baseline**

	Median	Min	Max	Nb missing values
Age (year)	31	19	63	0
Bodyweight (kg)	67.25	51	88.5	0
BMI (kg/m ²)	22.92	17.14	32.47	0
orosomucoid (g/L)	0.825	0.59	1.47	5
Albumin (g/L)	40	28.7	47	9
Sex	women : 20	men : 14		0
CDC Stage	stage A or B : 29	stage C : 5		0
Combivir coadministration	Yes : 24	No : 10		0
Good adherence	Yes : 15	No : 11		8
GENOTYPES	Wild type	Heterozygotes	Homozygote mutants	Nb missing values
MDR1 exon 26	13	14	3	4
MDR1 exon 21	22	5	4	3
CYP3A4*1B	12	3	15	4
CYP3A5*3	8	10	15	1
CYP2C19*2	17	11	2	4

Table 2. Population PK parameters (and relative standard error in %) of nelfinavir and M8 from basic and final models

	Basic model	Final model
	Estimate (RSE%)	Estimate (RSE%)
<i>Structural model</i>		
ka (h ⁻¹)	0.16 (25)	0.17 (27)
Tlag (h ⁻¹)	0.83 (6)	0.82 (6)
V/F (L)	176 (12)	191 (15)
CL _T /F (L/h)	51.3 (10)	52 (10)
$\frac{CL_m}{V_m}$ (h ⁻¹)	0.26 (40)	0.39 (35)
k _{em} (h ⁻¹)	1.56 (38)	1.76 (30)
$\beta_{\text{CYP2C19}} \frac{CL_m}{V_m}$	/	0.98 (49)
<i>Statistical model</i>		
ω_{ka} (%)	102 (37)	99 (42)
$\omega_{CL_T/F}$ (%)	50 (24)	49 (26)
$\omega_{\frac{CL_m}{V_m}}$ (%)	65 (30)	59 (29)
σ_{NFV} (%)	31 (15)	32 (15)
σ_{M8} (%)	48 (22)	49 (22)
$r \sigma_{NFV} - \sigma_{M8}$	/	0.37 (40)

Table 3 : Evolution of short term efficacy (during the 2 first weeks of treatment) and toxicity (from 4 weeks before to 4 weeks after initiating the treatment) and significance of this evolution.

	Basal Value		Value at week 2 or 4		Variation		test p
	Median	Range	Median	Range	Median	Range	
HIV RNA (log ₁₀ copies/mL)	4.86	2.95 – 6.04	2.93	1.60 – 4.57	1.80	1.25 – 2.73	< 10 ⁻⁴
Glycemia (mmol/L)	4.95	3.70 – 6.20	4.85	4.20 – 6.80	0.21	-1.5 – 1.7	0.05
Total cholesterol (mmol/L)	3.95	2.00 – 6.60	4.90	2.50 – 7.70	0.81	-1.49 – 3.7	10 ⁻⁴
HDL cholesterol (mmol/L)	1.17	0.46 – 1.92	1.28	0.39 – 2.20	0.01	-1.53 – 1.69	0.17
Triglycerides (mmol/L)	0.90	0.29 – 1.91	1.23	0.44 – 2.45	0.20	-0.68 – 1.17	0.20

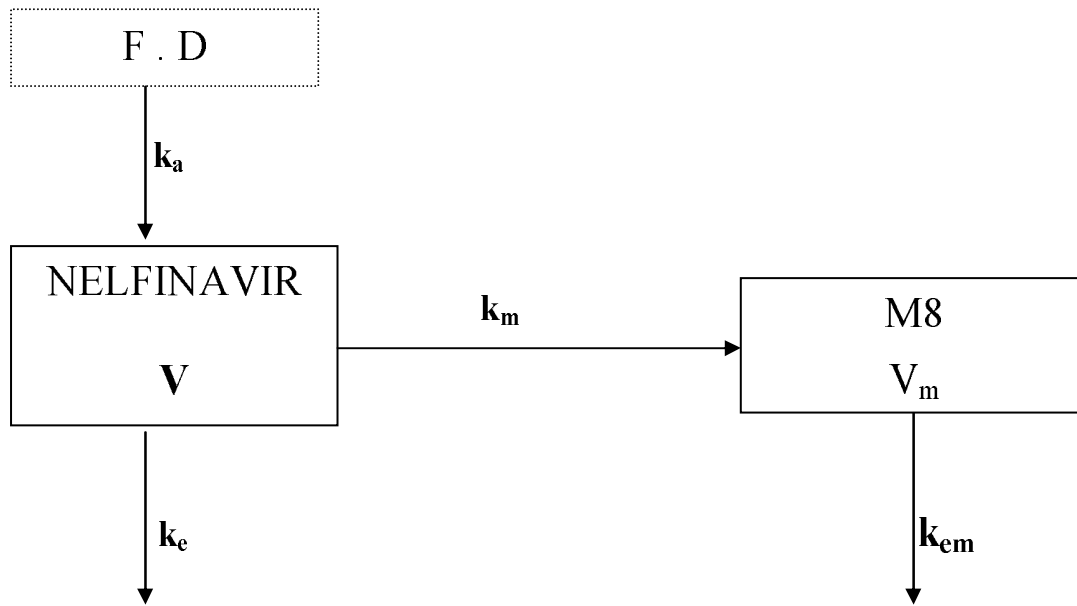

Figure 1

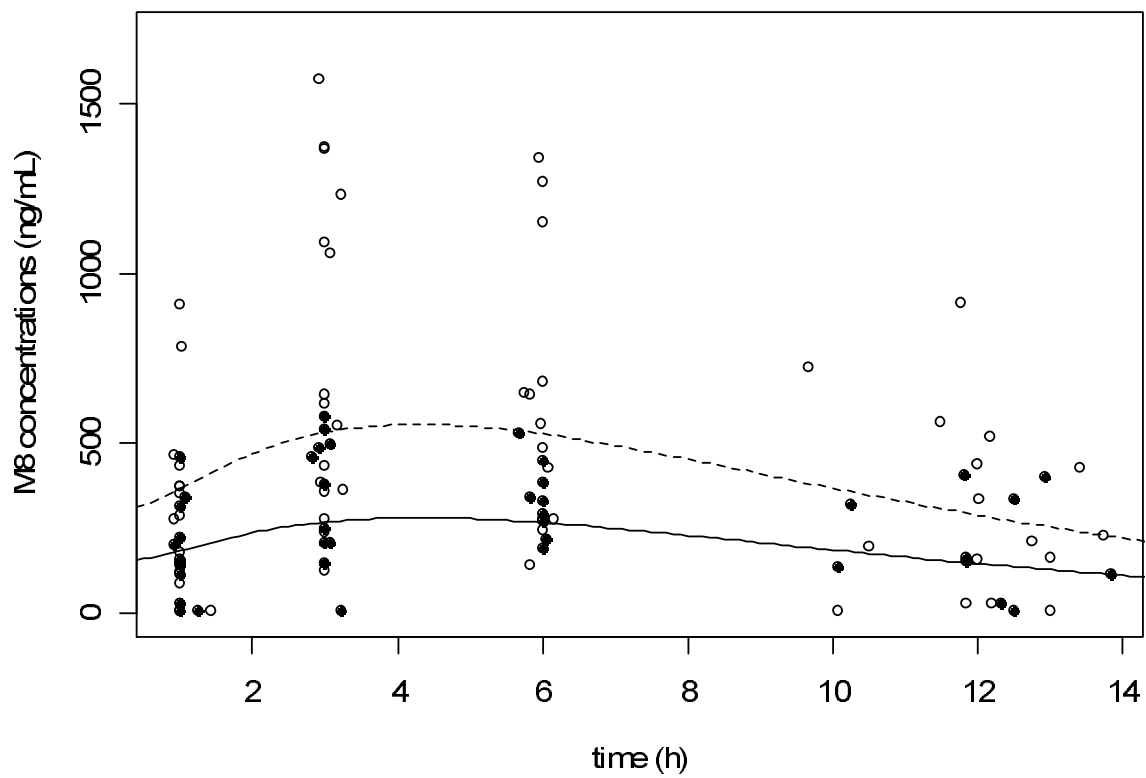
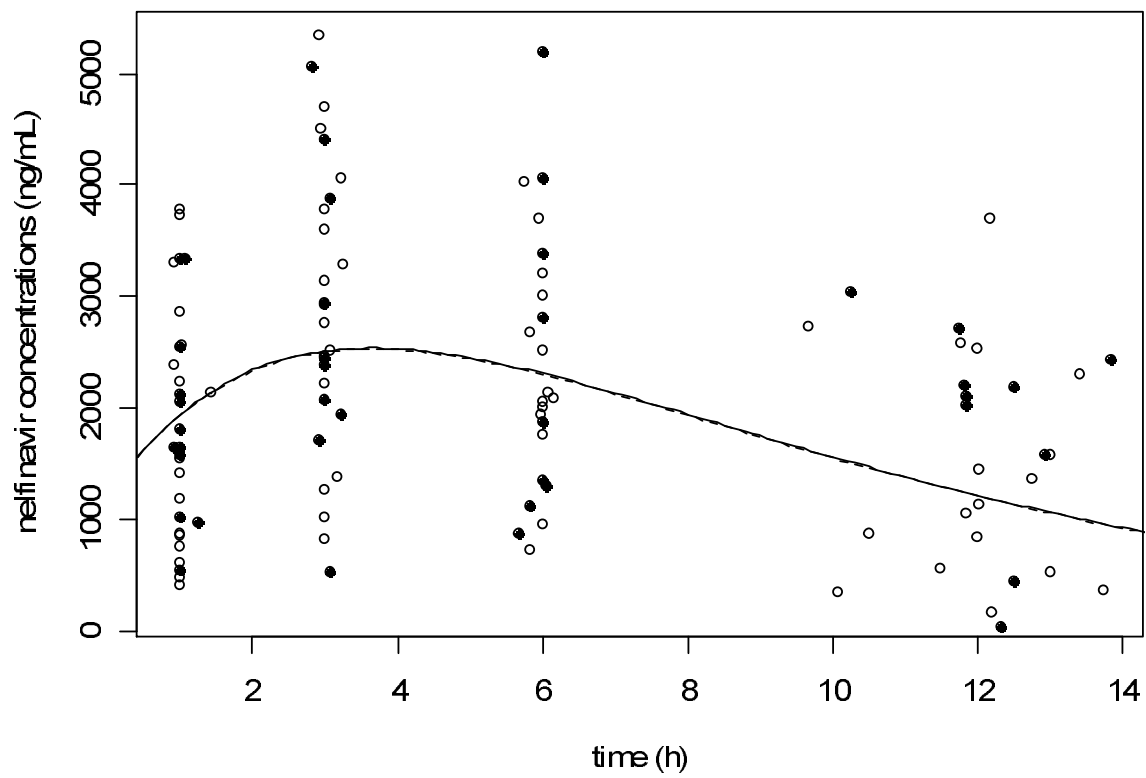

Figure 2

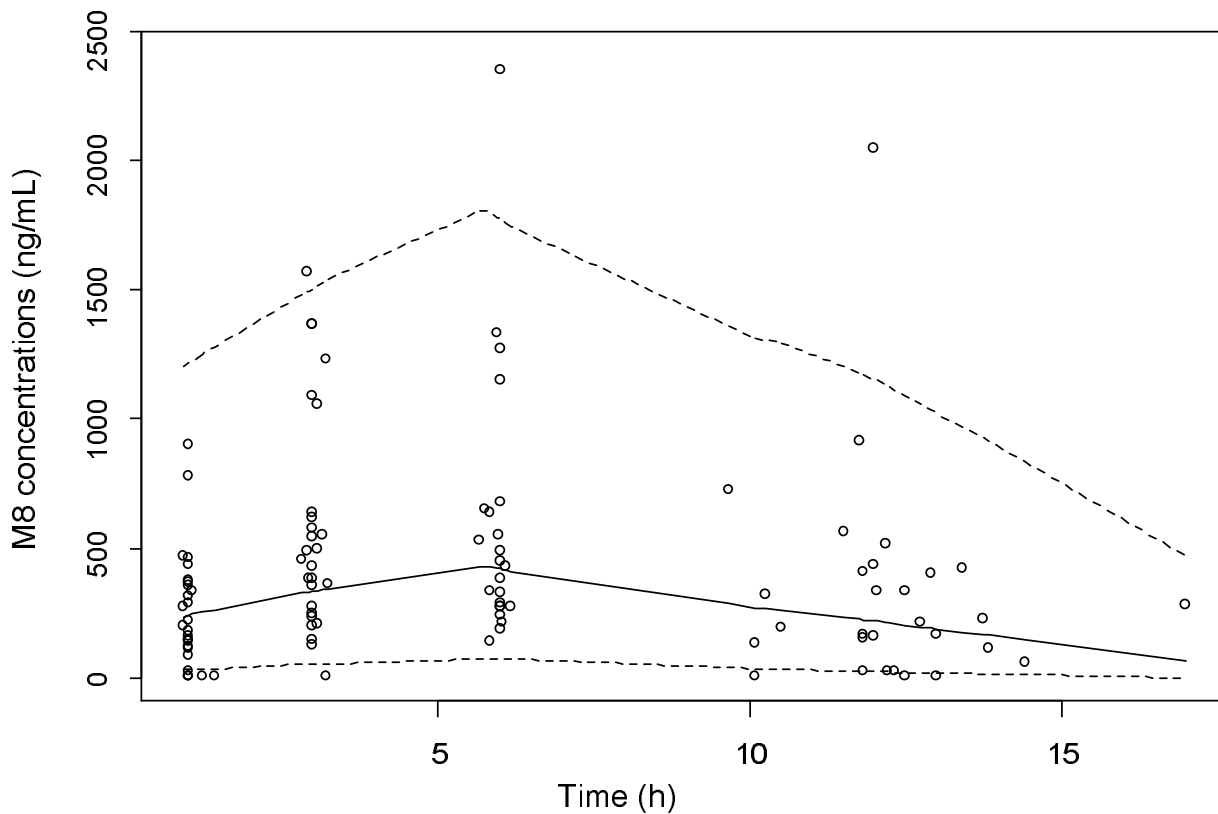
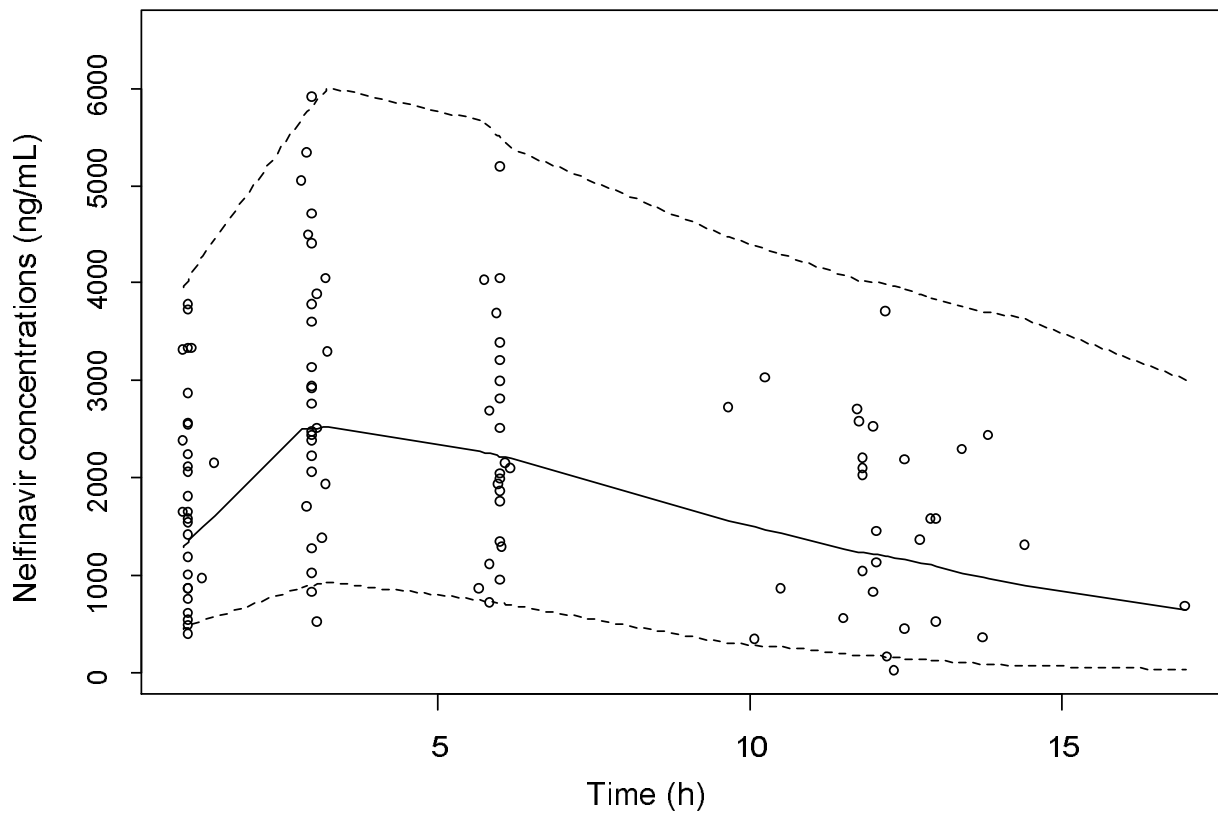

Figure 3

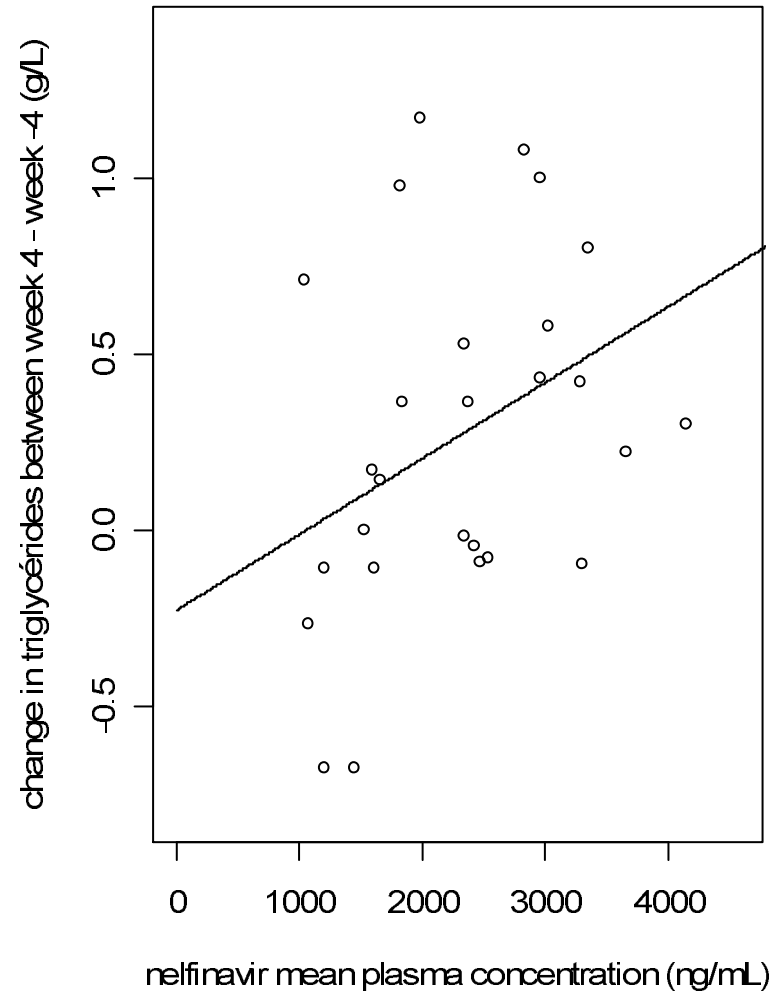
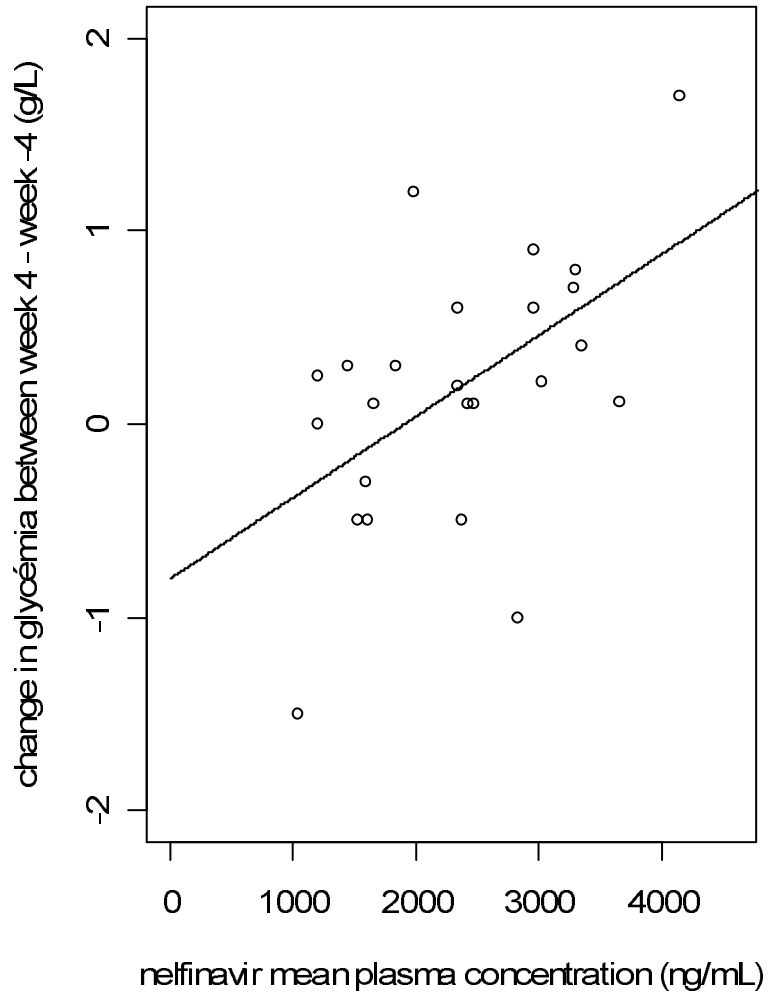

Figure 4

Legend for figures

Figure 1

Pharmacokinetic compartment model for nelfinavir and M8 plasma concentration after a nelfinavir oral dose D . Nelfinavir (in compartment 1) undergoes irreversible biotransformation to produce M8 (in compartment 2).

F denotes bioavailability of nelfinavir, k_a the first-order absorption rate constant, V the nelfinavir distribution volume, k_e the nelfinavir elimination constant rate, k_m the first order metabolic rate constant, V_m the M8 distribution volume and k_{em} is the M8 elimination rate constant.

Figure 2

Observed (points) and predicted (lines) plasma concentrations of nelfinavir (top) and M8 (bottom) vs. time: for CYP2C19 wild type, i.e. patients GG for CYP2C19*2 (empty points and dashed lines) and for CYP2C19 mutated patients, i.e. AG or AA for CYP2C19*2 (full points and lines). For nelfinavir, full and dashed lines are superposed.

Figure 3

Evaluation of the final model: comparison between the 5th (dash line), 50th (full line) and 95th (dash line) percentile obtained from 1000 simulations and the observed data (points) for nelfinavir (top) and M8 (bottom).

Figure 4

Correlation between $C_{mean,N}$ and the change in glycemia or triglycerides rate between week 4 and week -4.